

TOSHIBA Field Effect Transistor Silicon N Channel MOS Type (π -MOSIII)

2SK2611

DC-DC Converter, Relay Drive and Motor Drive Applications

Unit: mm

- Low drain-source ON resistance : $R_{DS(ON)} = 1.1 \Omega$ (typ.)
- High forward transfer admittance : $|Y_{fs}| = 7.0 \text{ S}$ (typ.)
- Low leakage current : $I_{DSS} = 100 \mu\text{A}$ (max) ($V_{DS} = 720 \text{ V}$)
- Enhancement-mode : $V_{th} = 2.0 \sim 4.0 \text{ V}$ ($V_{DS} = 10 \text{ V}$, $I_D = 1 \text{ mA}$)

Maximum Ratings ($T_a = 25^\circ\text{C}$)

| Characteristics | | Symbol | Rating | Unit |
|--|----------------|-----------|----------|------------------|
| Drain-source voltage | | V_{DSS} | 900 | V |
| Drain-gate voltage ($R_{GS} = 20 \text{ k}\Omega$) | | V_{DGR} | 900 | V |
| Gate-source voltage | | V_{GSS} | ± 30 | V |
| Drain current | DC (Note 1) | I_D | 9 | A |
| | Pulse (Note 1) | I_{DP} | 27 | A |
| Drain power dissipation ($T_c = 25^\circ\text{C}$) | | P_D | 150 | W |
| Single pulse avalanche energy (Note 2) | | E_{AS} | 663 | mJ |
| Avalanche current | | I_{AR} | 9 | A |
| Repetitive avalanche energy (Note 3) | | E_{AR} | 15 | mJ |
| Channel temperature | | T_{ch} | 150 | $^\circ\text{C}$ |
| Storage temperature range | | T_{stg} | -55~150 | $^\circ\text{C}$ |

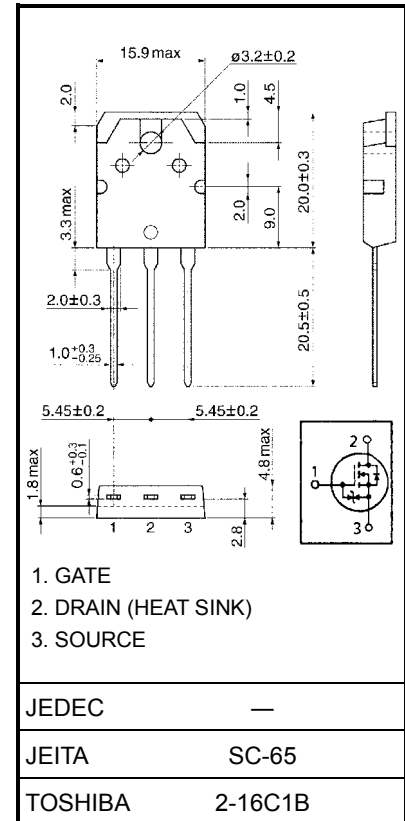

Weight: 4.6 g (typ.)

Thermal Characteristics

| Characteristics | Symbol | Max | Unit |
|--|----------------|-------|-----------------------------|
| Thermal resistance, channel to case | $R_{th(ch-c)}$ | 0.833 | $^\circ\text{C} / \text{W}$ |
| Thermal resistance, channel to ambient | $R_{th(ch-a)}$ | 50 | $^\circ\text{C} / \text{W}$ |

Note 1: Please use devices on condition that the channel temperature is below 150°C .

Note 2: $V_{DD} = 90 \text{ V}$, $T_{ch} = 25^\circ\text{C}$ (initial), $L = 15 \text{ mH}$, $R_G = 25 \Omega$, $I_{AR} = 9 \text{ A}$

Note 3: Repetitive rating: Pulse width limited by maximum channel temperature

This transistor is an electrostatic sensitive device.

Please handle with caution.

Electrical Characteristics (Ta = 25°C)

| Characteristics | | Symbol | Test Condition | Min | Typ. | Max | Unit |
|---|---------------|---------------|---|----------|------|----------|---------------|
| Gate leakage current | | I_{GSS} | $V_{GS} = \pm 30\text{ V}, V_{DS} = 0\text{ V}$ | — | — | ± 10 | μA |
| Gate-source breakdown voltage | | $V_{(BR)GSS}$ | $I_G = \pm 10\ \mu\text{A}, V_{DS} = 0\text{ V}$ | ± 30 | — | — | V |
| Drain cut-off current | | I_{DSS} | $V_{DS} = 720\text{ V}, V_{GS} = 0\text{ V}$ | — | — | 100 | μA |
| Drain-source breakdown voltage | | $V_{(BR)DSS}$ | $I_D = 10\text{ mA}, V_{GS} = 0\text{ V}$ | 900 | — | — | V |
| Gate threshold voltage | | V_{th} | $V_{DS} = 10\text{ V}, I_D = 1\text{ mA}$ | 2.0 | — | 4.0 | V |
| Drain-source ON resistance | | $R_{DS(ON)}$ | $V_{GS} = 10\text{ V}, I_D = 4\text{ A}$ | — | 1.1 | 1.4 | Ω |
| Forward transfer admittance | | $ Y_{fs} $ | $V_{DS} = 15\text{ V}, I_D = 4\text{ A}$ | 3.0 | 7.0 | — | S |
| Input capacitance | | C_{iss} | $V_{DS} = 25\text{ V}, V_{GS} = 0\text{ V}, f = 1\text{ MHz}$ | — | 2040 | — | pF |
| Reverse transfer capacitance | | C_{rss} | | — | 45 | — | |
| Output capacitance | | C_{oss} | | — | 190 | — | |
| Switching time | Rise time | t_r | <p>Duty $\leq 1\%$, $t_w = 10\ \mu\text{s}$</p> | — | 25 | — | ns |
| | Turn-on time | t_{on} | | — | 60 | — | |
| | Fall time | t_f | | — | 20 | — | |
| | Turn-off time | t_{off} | | — | 95 | — | |
| Total gate charge (gate-source plus gate-drain) | | Q_g | $V_{DD} \approx 400\text{ V}, V_{GS} = 10\text{ V}, I_D = 9\text{ A}$ | — | 58 | — | nC |
| Gate-source charge | | Q_{gs} | | — | 32 | — | |
| Gate-drain ("miller") Charge | | Q_{gd} | | — | 26 | — | |

Source-Drain Ratings and Characteristics (Ta = 25°C)

| Characteristics | Symbol | Test Condition | Min | Typ. | Max | Unit |
|---|-----------|---|-----|------|------|---------------|
| Continuous drain reverse current (Note 1) | I_{DR} | — | — | — | 9 | A |
| Pulse drain reverse current (Note 1) | I_{DRP} | — | — | — | 27 | A |
| Forward voltage (diode) | V_{DSF} | $I_{DR} = 9\text{ A}, V_{GS} = 0\text{ V}$ | — | — | -1.9 | V |
| Reverse recovery time | t_{rr} | $I_{DR} = 9\text{ A}, V_{GS} = 0\text{ V}, dI_{DR} / dt = 100\text{ A} / \mu\text{s}$ | — | 1.6 | — | μs |
| Reverse recovery charge | Q_{rr} | | — | 20 | — | μC |

Marking

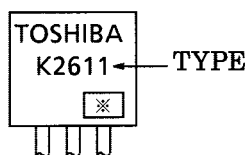

※ Lot Number

□ □ — Month (Starting from Alphabet A)

— Year (Last Number of the Christian Era)

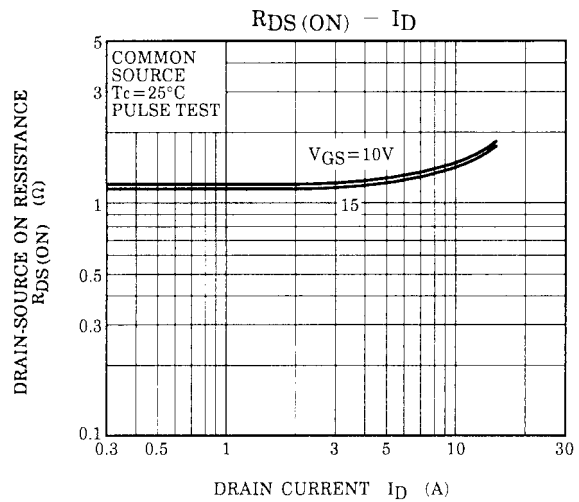
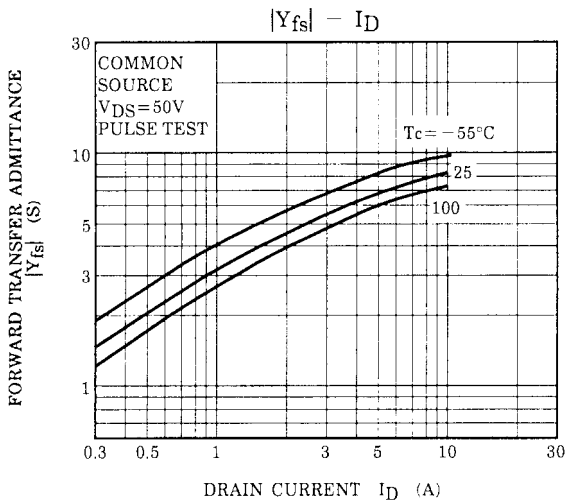
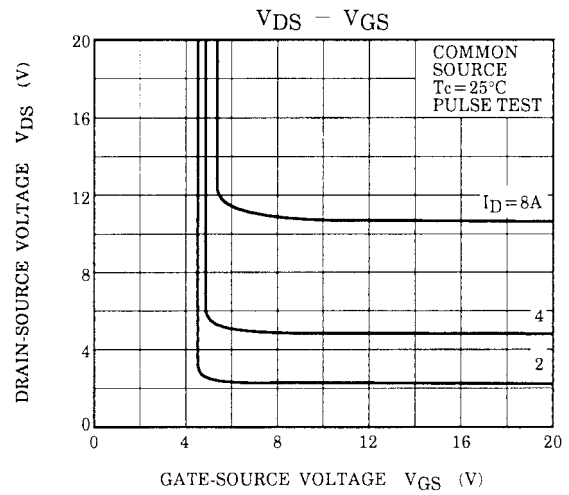
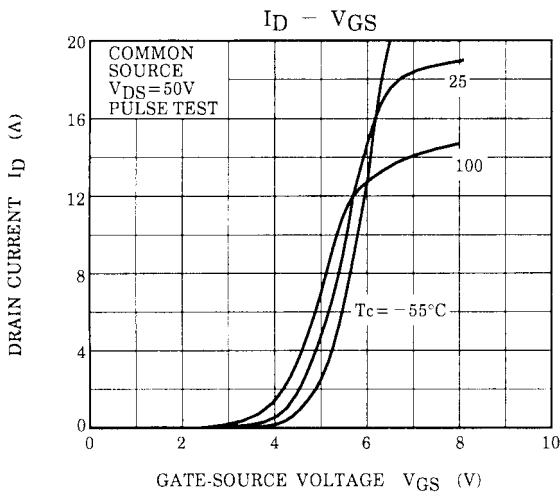
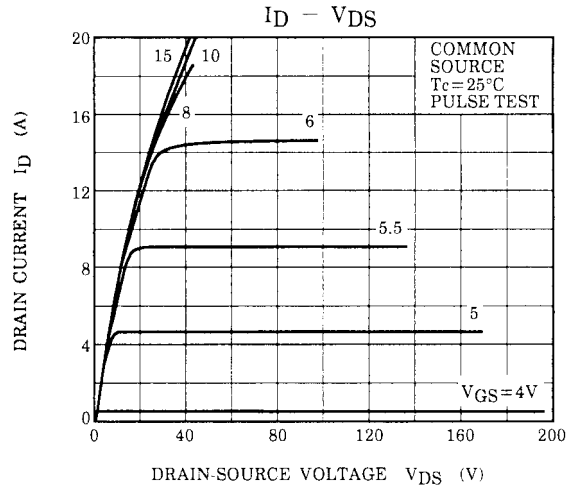
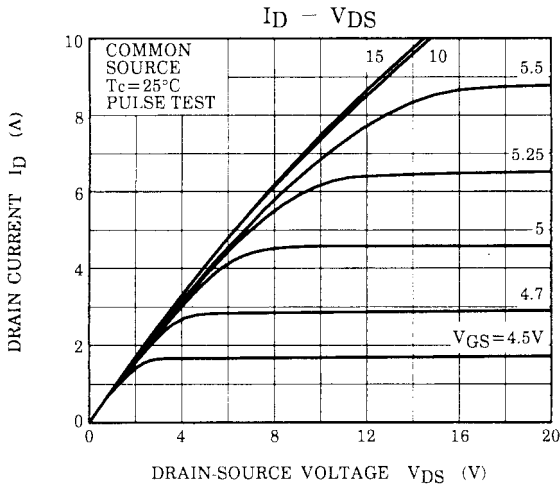

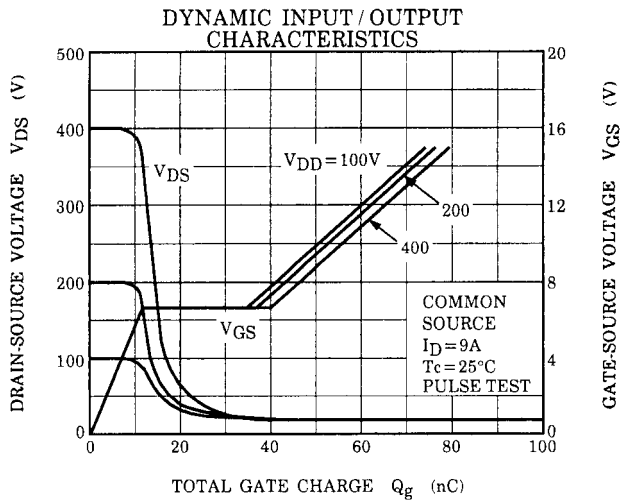
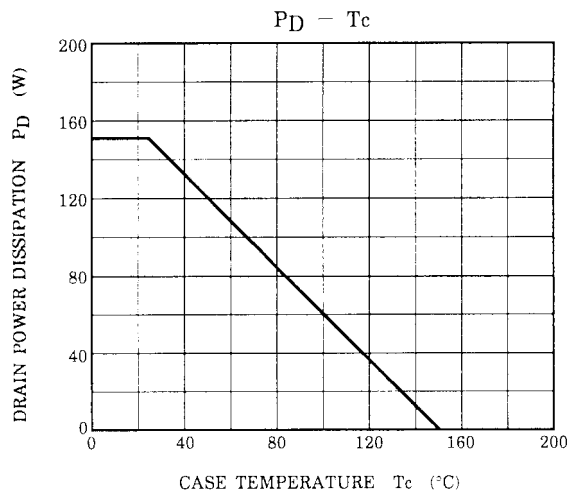
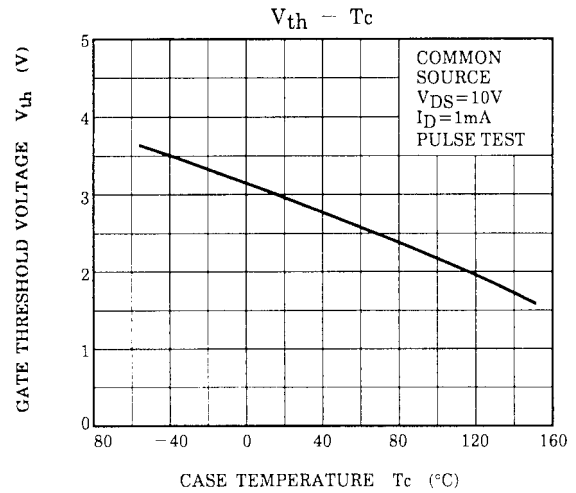
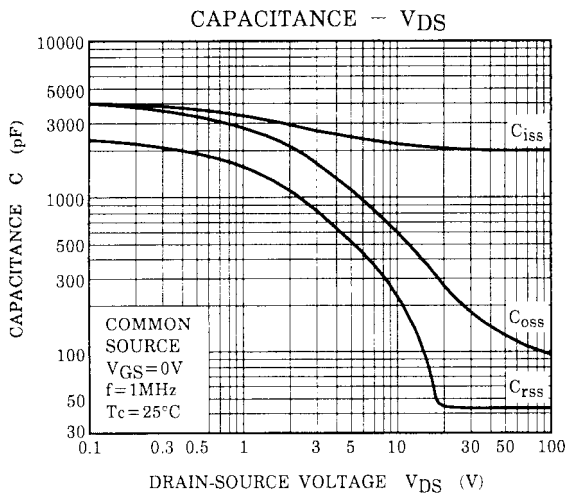
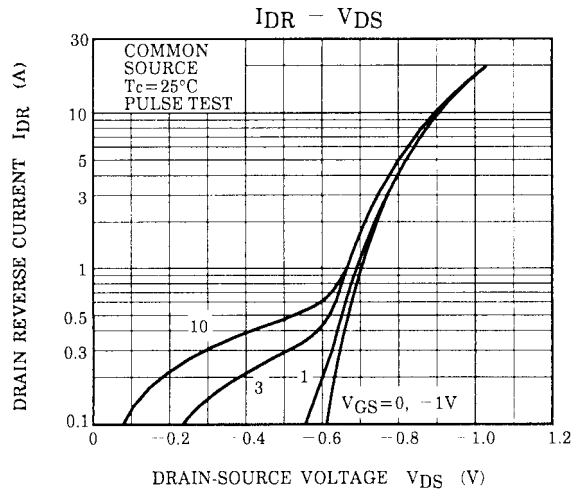
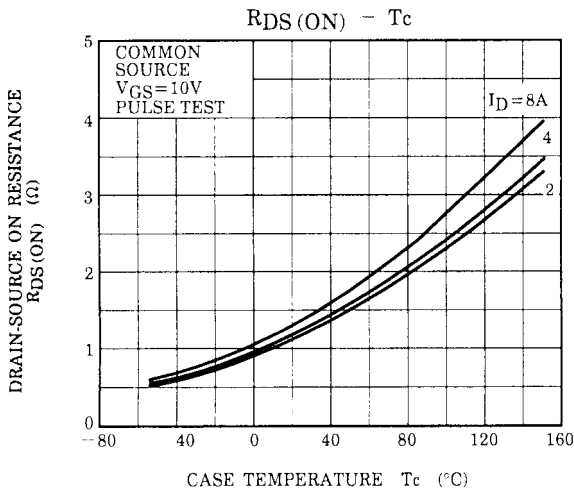

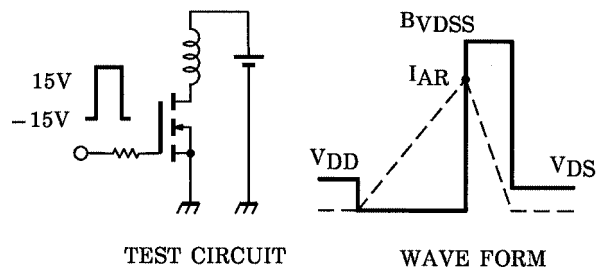
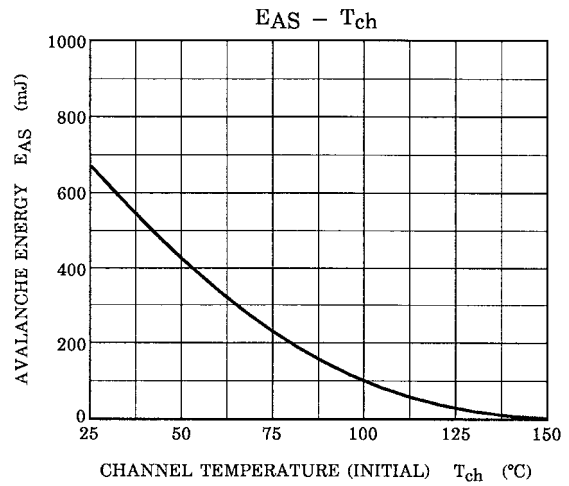
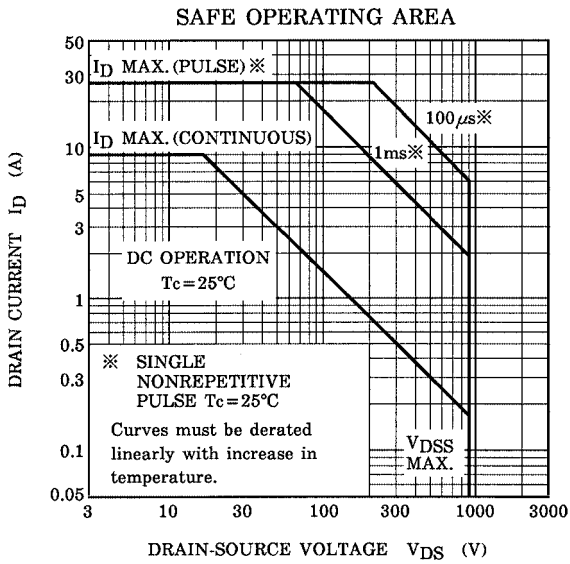
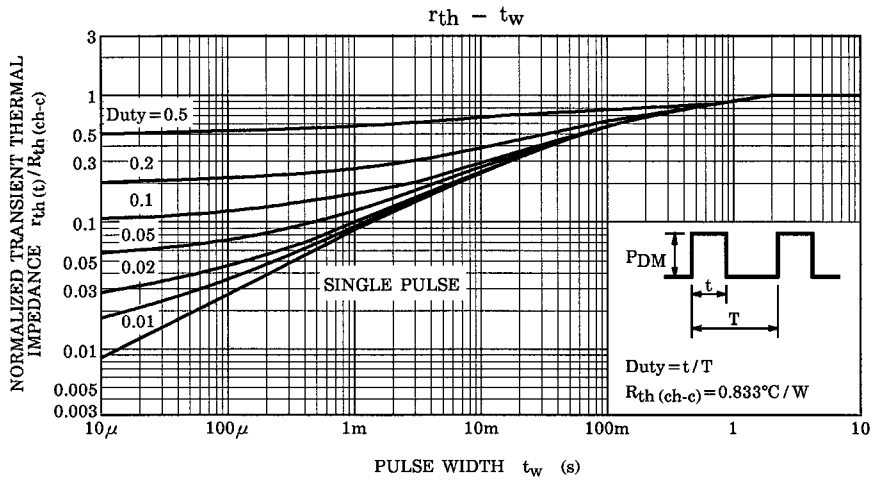

$R_G = 25 \Omega$
 $V_{DD} = 90 \text{ V}, L = 15 \text{ mH}$

$$EAS = \frac{1}{2} \cdot L \cdot I^2 \cdot \left(\frac{BVDSS}{BVDSS - V_{DD}} \right)$$

RESTRICTIONS ON PRODUCT USE

000707EAA

- TOSHIBA is continually working to improve the quality and reliability of its products. Nevertheless, semiconductor devices in general can malfunction or fail due to their inherent electrical sensitivity and vulnerability to physical stress. It is the responsibility of the buyer, when utilizing TOSHIBA products, to comply with the standards of safety in making a safe design for the entire system, and to avoid situations in which a malfunction or failure of such TOSHIBA products could cause loss of human life, bodily injury or damage to property.
In developing your designs, please ensure that TOSHIBA products are used within specified operating ranges as set forth in the most recent TOSHIBA products specifications. Also, please keep in mind the precautions and conditions set forth in the "Handling Guide for Semiconductor Devices," or "TOSHIBA Semiconductor Reliability Handbook" etc..
- The TOSHIBA products listed in this document are intended for usage in general electronics applications (computer, personal equipment, office equipment, measuring equipment, industrial robotics, domestic appliances, etc.). These TOSHIBA products are neither intended nor warranted for usage in equipment that requires extraordinarily high quality and/or reliability or a malfunction or failure of which may cause loss of human life or bodily injury ("Unintended Usage"). Unintended Usage include atomic energy control instruments, airplane or spaceship instruments, transportation instruments, traffic signal instruments, combustion control instruments, medical instruments, all types of safety devices, etc.. Unintended Usage of TOSHIBA products listed in this document shall be made at the customer's own risk.
- The information contained herein is presented only as a guide for the applications of our products. No responsibility is assumed by TOSHIBA CORPORATION for any infringements of intellectual property or other rights of the third parties which may result from its use. No license is granted by implication or otherwise under any intellectual property or other rights of TOSHIBA CORPORATION or others.
- The information contained herein is subject to change without notice.

This datasheet has been download from:

www.datasheetcatalog.com

Datasheets for electronics components.