

DESCRIPTION

2SC2905 is a silicon NPN epitaxial planar type transistor specifically designed for high power amplifiers applications in UHF band.

FEATURES

- High power output, high gain:
 $P_O \geq 45W, G_{pe} \geq 4.8dB$ @ $V_{CC} = 12.5V, f = 520MHz,$
 $P_{in} = 15W.$
- Emitter ballasted construction.
- High ruggedness: Ability to withstand more than 20:1 load VSWR when operated at $V_{CC} = 15.2V, P_O = 45W,$
 $f = 520MHz.$
- High reliability due to gold metalization die.
- Flange type ceramic package.
- $Z_{in} = 1.2 + j1.1\Omega, Z_{out} = 1.3 + j1.0\Omega$
 @ $V_{CC} = 12.5V, f = 520MHz, P_O = 45W.$

APPLICATION

For output stage of 35—40W power amplifiers in UHF band.

OUTLINE DRAWING

Dimensions in mm

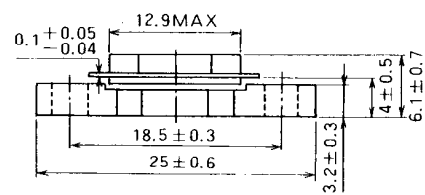
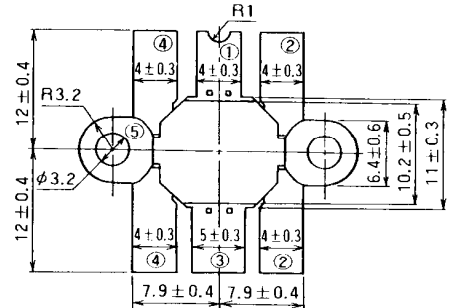

PIN :

- ① COLLECTOR
- ② EMITTER (FLANGE)
- ③ BASE
- ④ EMITTER (FLANGE)
- ⑤ FIN (EMITTER)

T-40E

ABSOLUTE MAXIMUM RATINGS ($T_C = 25^\circ C$)

Symbol	Parameter	Conditions	Ratings	Unit
V_{CBO}	Collector to base voltage		35	V
V_{EBO}	Emitter to base voltage		4	V
V_{CEO}	Collector to emitter voltage	$R_{BE} = \infty$	17	V
I_C	Collector current		15	A
P_C	Collector dissipation	$T_C = 25^\circ C$	120	W
T_j	Junction temperature		175	$^\circ C$
T_{stg}	Storage temperature		-55 to 175	$^\circ C$

Note. Above parameters are guaranteed independently.

ELECTRICAL CHARACTERISTICS ($T_C = 25^\circ C$)

Symbol	Parameter	Test conditions	Limits			Unit
			Min	Typ	Max	
$V_{(BR)EBO}$	Emitter to base breakdown voltage	$I_E = 10mA, I_C = 0$	4			V
$V_{(BR)CBO}$	Collector to base breakdown voltage	$I_C = 10mA, I_E = 0$	35			V
$V_{(BR)CEO}$	Collector to emitter breakdown voltage	$I_C = 0.1A, R_{BE} = \infty$	17			V
I_{CBO}	Collector cut off current	$V_{CB} = 15V, I_E = 0$			2	mA
I_{EBO}	Emitter cut off current	$V_{EB} = 3V, I_C = 0$			3	mA
h_{FE}	DC forward current gain *	$V_{CE} = 10V, I_C = 1A$	10	50	180	—
P_O	Power Output	$V_{CC} = 12.5V, P_{in} = 15W, f = 520MHz$	45	50		W
η_C	Collector efficiency		60	65		%

Note. * Pulse test, $P_W = 150\mu s, duty = 5\%.$

Above parameters, ratings, limits and conditions are subject to change.

MITSUBISHI RF POWER TRANSISTOR
2SC2905

NPN EPITAXIAL PLANAR TYPE

TEST CIRCUIT (f = 520MHz)

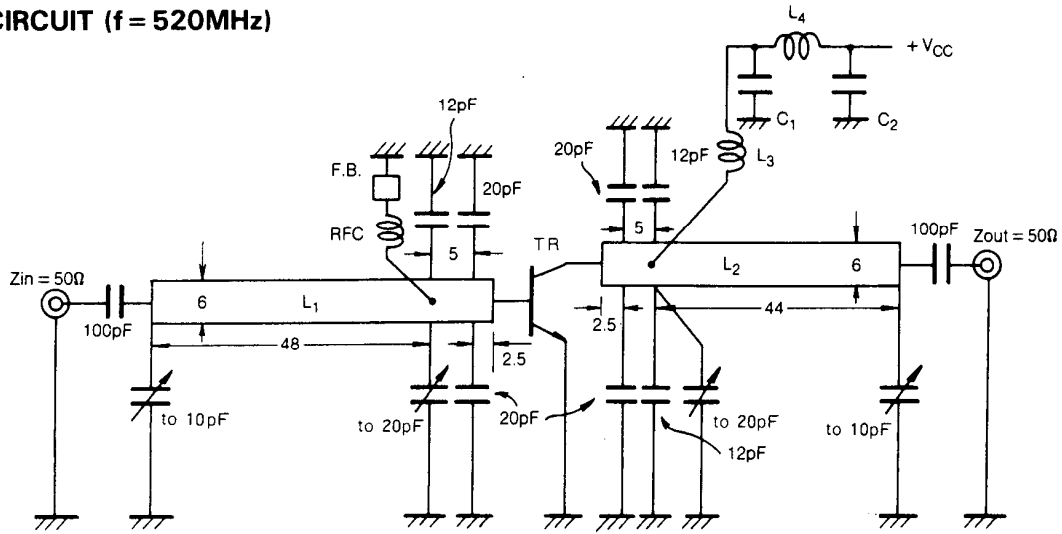

- Dimensions: mm
- L₁, L₂: Microstrip: Board Material 1.6mm Thick, glass-teflon $\epsilon_r = 2.7$
 - L₃: 1 Turn, AWG #13, 8mm I.D.
 - L₄: 5 Turns, AWG #13, 8mm I.D.
 - RFC: 9 Turns, AWG #20, 4mm I.D.
 - F.B.: Ferrite Bead
 - C₁: 82pF, 220pF, 2200pF, 4700pF, 33 μ F in Parallel
 - C₂: 82pF, 220pF, 2200pF, 4700pF, 22 μ F in Parallel

TEST CIRCUIT BOARD LAYOUT (f = 520MHz)

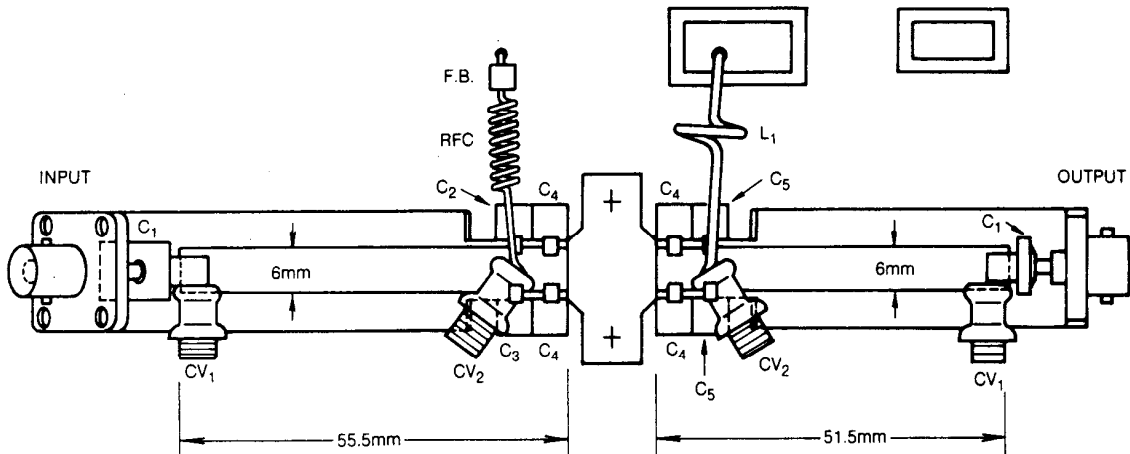

- C₁: 100pF(Ribbon Lead Mica)
- C₂: 12pF(Ribbon Lead Mica)
- C₃: 0
- C₄: 20pF(Ribbon Lead Mica)
- C₅: 12pF(Ribbon Lead Mica)
- CV₁: -10pF(Air Variable Capacitor) muRata TTA 43 A 100A
- CV₂: -20pF(Air Variable Capacitor) muRata TTA 45 A 200A
- F.B.: Ferrite Bead
- RFC: 9 Turns, AWG #20, 4mm I.D.
- L₁: 1 Turns, AWG #13, 8mm I.D.
- Microstrip: Board Material 1.6mm Thick, glass-teflon $\epsilon_r = 2.7$

NPN EPITAXIAL PLANAR TYPE

TYPICAL PERFORMANCE DATA

COLLECTOR DISSIPATION VS. CASE TEMPERATURE

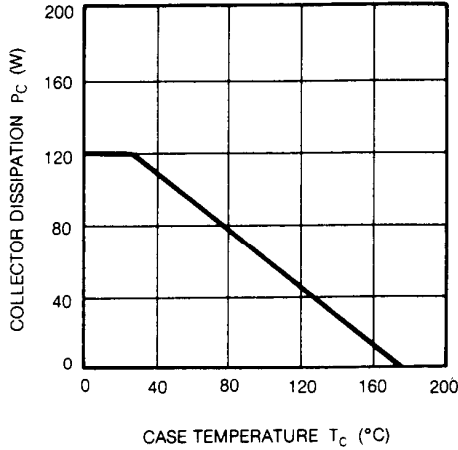

COLLECTOR OUTPUT CAPACITANCE VS. COLLECTOR TO BASE VOLTAGE

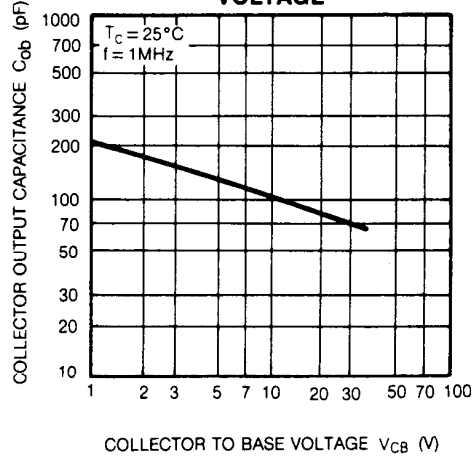

OUTPUT POWER, COLLECTOR EFFICIENCY VS. INPUT POWER

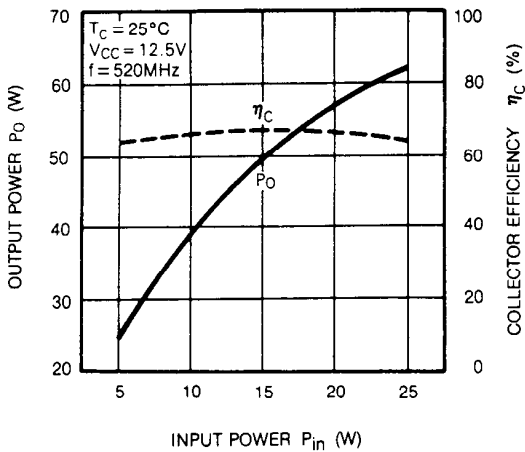

OUTPUT POWER VS. COLLECTOR SUPPLY VOLTAGE

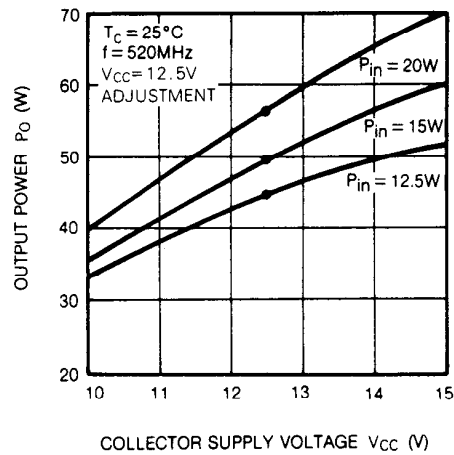

OUTPUT POWER VS. FREQUENCY

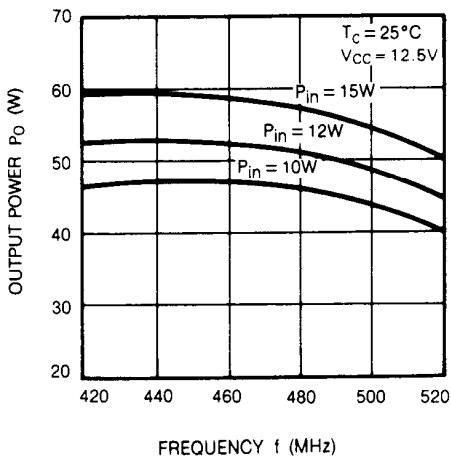

SERIES INPUT AND OUTPUT IMPEDANCE VS. FREQUENCY CHARACTERISTICS

