

DM54LS86/DM74LS86 Quad 2-Input Exclusive-OR Gates

General Description

This device contains four independent gates each of which performs the logic exclusive-OR function.

Connection Diagram

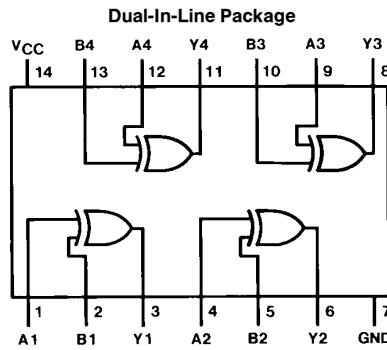

Order Number DM54LS86J, DM54LS86W, DM74LS86M or DM74LS86N
See NS Package Number J14A, M14A, N14A or W14B

Function Table

$$Y = A \oplus B = \bar{A}B + A\bar{B}$$

Inputs		Output
A	B	Y
L	L	L
L	H	H
H	L	H
H	H	L

H = High Logic Level
L = Low Logic Level

Absolute Maximum Ratings (Note)

If Military/Aerospace specified devices are required, please contact the National Semiconductor Sales Office/Distributors for availability and specifications.

Supply Voltage	7V
Input Voltage	7V
Operating Free Air Temperature Range	
DM54LS	−55°C to +125°C
DM74LS	0°C to +70°C
Storage Temperature Range	−65°C to +150°C

Note: The "Absolute Maximum Ratings" are those values beyond which the safety of the device cannot be guaranteed. The device should not be operated at these limits. The parametric values defined in the "Electrical Characteristics" table are not guaranteed at the absolute maximum ratings. The "Recommended Operating Conditions" table will define the conditions for actual device operation.

Recommended Operating Conditions

Symbol	Parameter	DM54LS86			DM74LS86			Units
		Min	Nom	Max	Min	Nom	Max	
V _{CC}	Supply Voltage	4.5	5	5.5	4.75	5	5.25	V
V _{IH}	High Level Input Voltage	2			2			V
V _{IL}	Low Level Input Voltage			0.7			0.8	V
I _{OH}	High Level Output Current			−0.4			−0.4	mA
I _{OL}	Low Level Output Current			4			8	mA
T _A	Free Air Operating Temperature	−55		125	0		70	°C

Electrical Characteristics over recommended operating free air temperature range (unless otherwise noted)

Symbol	Parameter	Conditions	Min	Typ (Note 1)	Max	Units
V _I	Input Clamp Voltage	V _{CC} = Min, I _I = −18 mA			−1.5	V
V _{OH}	High Level Output Voltage	V _{CC} = Min, I _{OH} = Max, V _{IL} = Max, V _{IH} = Min	DM54 2.5	3.4		V
V _{OL}	Low Level Output Voltage	V _{CC} = Min, I _{OL} = Max, V _{IL} = Max, V _{IH} = Min	DM54 0.25	0.25	0.4	V
			DM74 0.35	0.35	0.5	
		I _{OL} = 4 mA, V _{CC} = Min	DM74 0.25	0.25	0.4	
I _I	Input Current @ Max Input Voltage	V _{CC} = Max, V _I = 7V			0.2	mA
I _{IH}	High Level Input Current	V _{CC} = Max, V _I = 2.7V			40	μA
I _{IL}	Low Level Input Current	V _{CC} = Max, V _I = 0.4V			−0.6	mA
I _{OS}	Short Circuit Output Current	V _{CC} = Max (Note 2)	DM54 −20		−100	mA
			DM74 −20		−100	
I _{CCH}	Supply Current with Outputs High	V _{CC} = Max (Note 3)		6.1	10	mA
I _{CCL}	Supply Current with Outputs Low	V _{CC} = Max (Note 4)		9	15	mA

Note 1: All typicals are at V_{CC} = 5V, T_A = 25°C.

Note 2: Not more than one output should be shorted at a time, and the duration should not exceed one second.

Note 3: I_{CCH} is measured with all outputs open, one input at each gate at 4.5V, and the other inputs grounded.

Note 4: I_{CCL} is measured with all outputs open and all inputs grounded.

Switching Characteristics at $V_{CC} = 5V$ and $T_A = 25^\circ C$ (See Section 1 for Test Waveforms and Output Load)

Symbol	Parameter	Conditions	$R_L = 2\text{ k}\Omega$				Units
			$C_L = 15\text{ pF}$		$C_L = 50\text{ pF}$		
			Min	Max	Min	Max	
t_{PLH}	Propagation Delay Time Low to High Level Output	Other Input Low		18		23	ns
t_{PHL}	Propagation Delay Time High to Low Level Output			17		21	ns
t_{PLH}	Propagation Delay Time Low to High Level Output	Other Input High		10		15	ns
t_{PHL}	Propagation Delay Time High to Low Level Output			12		15	ns

Physical Dimensions inches (millimeters)

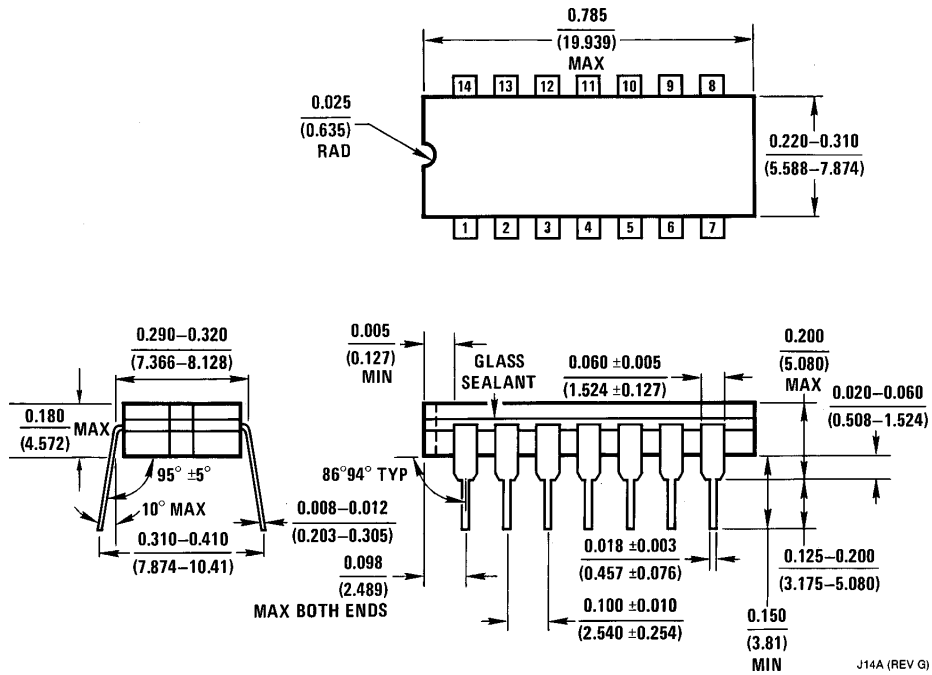

14-Lead Ceramic Dual-In-Line Package (J)
 Order Number DM54LS86J
 NS Package Number J14A

J14A (REV G)

Physical Dimensions inches (millimeters) (Continued)

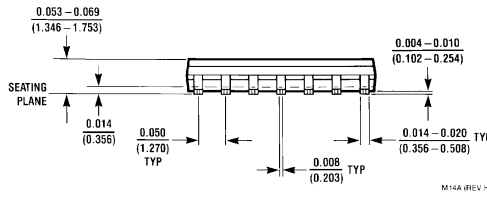
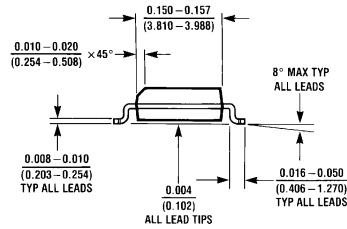
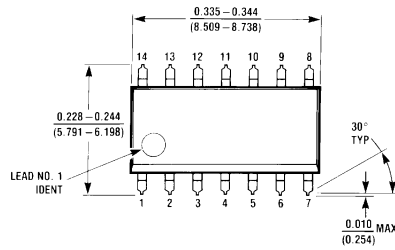

14-Lead Small Outline Molded Package (M)
Order Number DM74LS86M
NS Package Number M14A

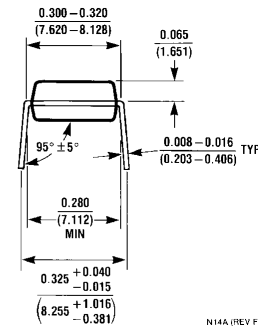
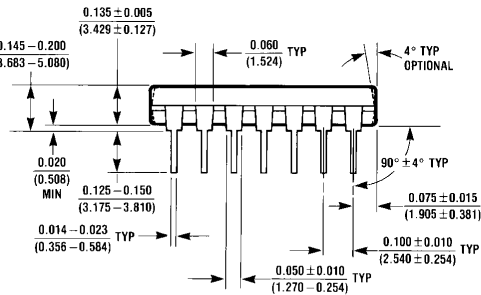
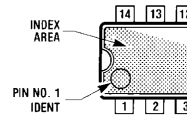
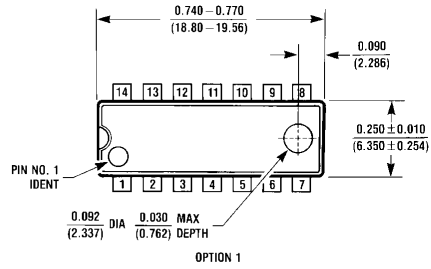

14-Lead Molded Dual-In-Line Package (N)
Order Number DM74LS86N
NS Package Number N14A

Physical Dimensions inches (millimeters) (Continued)

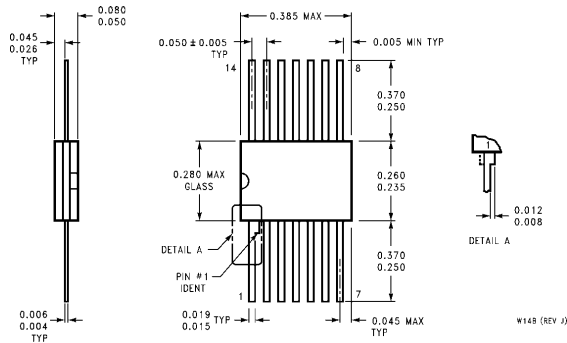

14-Lead Ceramic Flat Package (W)
Order Number DM74LS86W
NS Package Number W14B

LIFE SUPPORT POLICY

NATIONAL'S PRODUCTS ARE NOT AUTHORIZED FOR USE AS CRITICAL COMPONENTS IN LIFE SUPPORT DEVICES OR SYSTEMS WITHOUT THE EXPRESS WRITTEN APPROVAL OF THE PRESIDENT OF NATIONAL SEMICONDUCTOR CORPORATION. As used herein:

1. Life support devices or systems are devices or systems which, (a) are intended for surgical implant into the body, or (b) support or sustain life, and whose failure to perform, when properly used in accordance with instructions for use provided in the labeling, can be reasonably expected to result in a significant injury to the user.
2. A critical component is any component of a life support device or system whose failure to perform can be reasonably expected to cause the failure of the life support device or system, or to affect its safety or effectiveness.



National Semiconductor Corporation
 1111 West Bardin Road
 Arlington, TX 76017
 Tel: 1(800) 272-9959
 Fax: 1(800) 737-7018

National Semiconductor Europe
 Fax: (+49) 0-180-530 85 86
 Email: cnjwge@tevm2.nsc.com
 Deutsch Tel: (+49) 0-180-530 85 85
 English Tel: (+49) 0-180-532 78 32
 Français Tel: (+49) 0-180-532 93 58
 Italiano Tel: (+49) 0-180-534 16 80

National Semiconductor Hong Kong Ltd.
 19th Floor, Straight Block,
 Ocean Centre, 5 Canton Rd.
 Tsimshatsui, Kowloon
 Hong Kong
 Tel: (852) 2737-1600
 Fax: (852) 2736-9960

National Semiconductor Japan Ltd.
 Tel: 81-043-299-2309
 Fax: 81-043-299-2408

National does not assume any responsibility for use of any circuitry described, no circuit patent licenses are implied and National reserves the right at any time without notice to change said circuitry and specifications.

This datasheet has been downloaded from:

www.DatasheetCatalog.com

Datasheets for electronic components.

National Semiconductor was acquired by Texas Instruments.

http://www.ti.com/corp/docs/investor_relations/pr_09_23_2011_national_semiconductor.html

This file is the datasheet for the following electronic components:

DM74LS86W - <http://www.ti.com/product/dm74ls86w?HQS=TI-null-null-dscatalog-df-pf-null-ww>

DM74LS86N - <http://www.ti.com/product/dm74ls86n?HQS=TI-null-null-dscatalog-df-pf-null-ww>

DM74LS86W - <http://www.ti.com/product/dm74ls86w?HQS=TI-null-null-dscatalog-df-pf-null-ww>

DM74LS86M - <http://www.ti.com/product/dm74ls86m?HQS=TI-null-null-dscatalog-df-pf-null-ww>

DM74LS86N - <http://www.ti.com/product/dm74ls86n?HQS=TI-null-null-dscatalog-df-pf-null-ww>

DM54LS86J - <http://www.ti.com/product/dm54ls86j?HQS=TI-null-null-dscatalog-df-pf-null-ww>

DM54LS86J - <http://www.ti.com/product/dm54ls86j?HQS=TI-null-null-dscatalog-df-pf-null-ww>

DM74LS86N - <http://www.ti.com/product/dm74ls86n?HQS=TI-null-null-dscatalog-df-pf-null-ww>

DM54LS86W - <http://www.ti.com/product/dm54ls86w?HQS=TI-null-null-dscatalog-df-pf-null-ww>

DM74LS86W - <http://www.ti.com/product/dm74ls86w?HQS=TI-null-null-dscatalog-df-pf-null-ww>

DM74LS86M - <http://www.ti.com/product/dm74ls86m?HQS=TI-null-null-dscatalog-df-pf-null-ww>

DM54LS86W - <http://www.ti.com/product/dm54ls86w?HQS=TI-null-null-dscatalog-df-pf-null-ww>

DM74LS86M - <http://www.ti.com/product/dm74ls86m?HQS=TI-null-null-dscatalog-df-pf-null-ww>