

Features

- Trench Field Stop technology IGBT adopted
- Low saturation voltage
- Positive temperature coefficient
- Fast switching
- Free wheeling diodes with fast and soft reverse recovery
- Industrial standard package with insulated substrate
- Temperature sensor included

Applications

- Input from single or three phase grid
- Three phase synchronous or asynchronous motor
- Dynamic braking operation

Preliminary Data

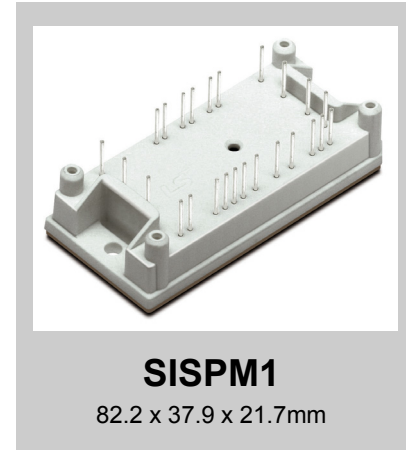

Internal Equivalent Circuit

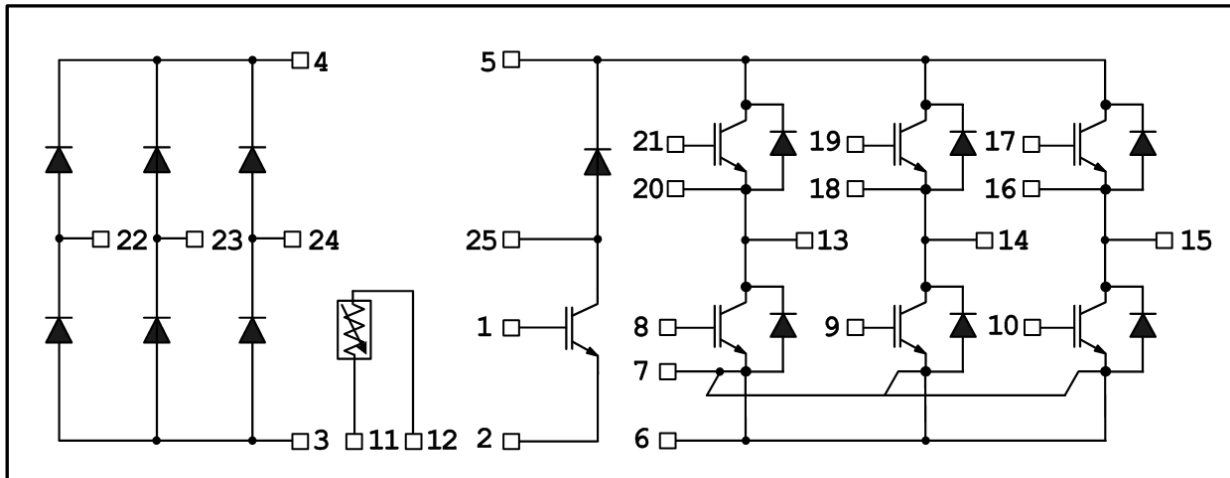

Pin Description

Pin Number	Pin Name	Pin Description
1	GB	Gate Input for Braking IGBT
2	EB	Emitter Input for Braking IGBT
3	DCN	Negative DC Link Output
4	DCP	Positive DC Link Output
5	P	Positive DC Link Input
6	N	Negative DC Link Input
7	COM	Common Supply Ground
8, 9, 10	GUN, GVN, GWN	Gate Input for Low-side U Phase, V Phase, W Phase
11, 12	TH1, TH2	NTC-, NTC+
13, 14, 15	U, V, W	Output for U Phase, V Phase, W Phase
16, 18, 20	EWP, EVP, EUP	Emitter Input for High-side W Phase, V Phase, U Phase
17, 19, 21	GWP, GVP, GUP	Gate Input for High-side W Phase, V Phase, U Phase
22, 23, 24	R, S, T	Input for R Phase, S Phase, T Phase
25	B	Output for Braking

Absolute Maximum Ratings $T_C = 25^\circ\text{C}$ unless otherwise noted

Item	Symbol	Parameter	Conditions	Value	Units
Input Rectifier	V_{RPM}	Repetitive Peak Reverse Voltage		1600	V
	I_{FAV}	Forward Current per Diode	@ $T_j = 150^\circ\text{C}$, $T_C = 80^\circ\text{C}$	15	A
	I_{FSM}	Surge Forward Current (Chip level)	@ $t_p = 10$ ms, half sine wave	220	A
	I^2t	I^2t - Value (Chip level)	@ $t_p = 10$ ms, half sine wave	200	A^2s
	P_D	Maximum Power Dissipation	@ $T_j = 150^\circ\text{C}$, $T_C = 80^\circ\text{C}$	40	W
	T_j	Operating Junction Temperature ⁽¹⁾	-	-40 ~ 125	$^\circ\text{C}$
Transistor Inverter	V_{CES}	Collector-Emitter Breakdown Voltage	-	600	V
	V_{GES}	Gate-Emitter Peak Voltage	-	± 20	V
	I_C	DC Collector Current	@ $T_j = 175^\circ\text{C}$, $T_C = 80^\circ\text{C}$	15	A
	I_{cpulse}	Repetitive Peak Collector Current	@ $t_p = 1$ ms	30	A
	P_D	Maximum Power Dissipation	@ $T_j = 175^\circ\text{C}$, $T_C = 80^\circ\text{C}$	40	W
	T_{SC}	SC Withstand Time (Chip level)	$V_{GE} = 15$ V, $V_{CE} = 300$ V	5	μs
Diode Inverter	T_j	Operating Junction Temperature ⁽²⁾	-	-40 ~ 125	$^\circ\text{C}$
	V_{RRM}	Repetitive Peak Reverse Voltage	-	600	V
	I_F	DC Forward Current	@ $T_j = 175^\circ\text{C}$, $T_C = 80^\circ\text{C}$	15	A
	I_{FRM}	Repetitive Peak Forward Current	@ $t_p = 1$ ms	30	A
	P_D	Maximum Power Dissipation	@ $T_j = 175^\circ\text{C}$, $T_C = 80^\circ\text{C}$	35	W
Transistor Brake	T_j	Operating Junction Temperature ⁽²⁾	-	-40 ~ 125	$^\circ\text{C}$
	V_{CES}	Collector-Emitter Breakdown Voltage	-	600	V
	V_{GES}	Gate-Emitter Peak Voltage	-	± 20	V
	I_C	DC Collector Current	@ $T_j = 175^\circ\text{C}$, $T_C = 80^\circ\text{C}$	15	A
	I_{cpulse}	Repetitive Peak Collector Current	@ $t_p = 1$ ms	30	A
	P_D	Maximum Power Dissipation	@ $T_j = 175^\circ\text{C}$, $T_C = 80^\circ\text{C}$	40	W
	T_{SC}	SC Withstand Time (Chip level)	@ $V_{GE} = 15$ V, $V_{CE} = 300$ V	5	μs
Diode Brake	T_j	Operating Junction Temperature ⁽²⁾	-	-40 ~ 125	$^\circ\text{C}$
	V_{RRM}	Repetitive Peak Reverse Voltage	-	600	V
	I_F	DC Forward Current	@ $T_j = 175^\circ\text{C}$, $T_C = 80^\circ\text{C}$	15	A
	I_{FRM}	Repetitive Peak Forward Current	@ $t_p = 1$ ms	30	A
	P_D	Maximum Power Dissipation	@ $T_j = 175^\circ\text{C}$, $T_C = 80^\circ\text{C}$	35	W
Module	T_{stg}	Storage Temperature	-	-40~125	$^\circ\text{C}$
	V_{iso}	Isolation Voltage	@ AC 1minute	2500	V
	W	Weight	-	50	g

(Note *1) The Maximum junction temperature of chip is 150°C .

(Note *2) The Maximum junction temperature of chip is 175°C .

LEC15G604

Electrical Characteristics $T_C = 25^\circ\text{C}$ unless otherwise noted

Input Rectifier Characteristics

Symbol	Parameter	Conditions	Min	Typ	Max	Units
V_F	Diode Forward Voltage	$T_C = 25^\circ\text{C}, I_F = 15\text{ A}$	-	1.1	-	V
		$T_C = 125^\circ\text{C}, I_F = 15\text{ A}$	-	1.0	-	V
V_{to}	Threshold Voltage	$T_C = 125^\circ\text{C}$	-	0.83	-	V
I_R	Reverse Current (Chip level)	$T_C = 25^\circ\text{C}, V_{RRM} = 300\text{ V}$	-	0.1	-	mA
r_t	Slope Resistance	$T_C = 125^\circ\text{C}$	-	20.8	-	m Ω
$R_{th(J-C)}$	Thermal Resistance (IGBT Part)	Junction-to-Case	-	1.3	-	$^\circ\text{C/W}$

Transistor-Inverter Characteristics

Symbol	Parameter	Conditions	Min	Typ	Max	Units
$V_{GE(th)}$	Gate-Emitter threshold Voltage	$V_{CE} = V_{GE}, I_{CE} = 15\text{ mA}$	-	6.5	-	V
$V_{CE(sat)}$	Collector-Emitter Saturation Voltage	$T_C = 25^\circ\text{C}, I_{CE} = 15\text{ A}, V_{GE} = 15\text{ V}$	-	1.95	-	V
		$T_C = 125^\circ\text{C}, I_{CE} = 15\text{ A}, V_{GE} = 15\text{ V}$	-	2.35	-	V
I_{CES}	Collector-Emitter Cut-off Current	$V_{GE} = 0\text{ V}, V_{CE} = 300\text{ V}$	-	-	250	μA
I_{CES}	Gate-Emitter Leakage Current	$V_{GE} = \pm 20\text{ V}, V_{CE} = 0\text{ V}$	-	-	-	A
C_{iss}	Input Capacitance	$V_{CE} = 50\text{ V}, V_{GE} = 0\text{ V}$ $f = 100\text{ kHz}, T_C = 25^\circ\text{C}$ (Chip level)	-	-	-	nF
C_{oss}	Output Capacitance		-	-	-	nF
C_{rss}	Reverse Transfer Capacitance		-	-	-	nF
$t_d(on)$	Turn-On Delay Time	$T_C = 125^\circ\text{C}, R_{G ON} = 40\ \Omega$ $R_{G OFF} = 20\ \Omega, L = 500\ \mu\text{H}$ $V_{CE} = 300\text{ V}, V_{GE} = 0\text{ V} \sim 15\text{ V}$ $I_{CE} = 15\text{ A}$	-	64	-	ns
t_r	Rise Time		-	43	-	ns
$t_d(off)$	Turn-Off Delay Time		-	82	-	ns
t_f	Fall Time		-	96	-	ns
E_{on}	Turn-On Switching Loss		-	0.55	-	mJ
E_{off}	Turn-Off Switching Loss	-	0.21	-	mJ	
E_{ts}	Total Switching Loss	-	0.76	-	mJ	
Q_G	Total Gate Charge	$V_{GE} = 0\text{ V} \sim 15\text{ V}$	-	43	-	nC
Q_{GE}	Gate-Emitter Charge		-	21	-	nC
Q_{GC}	Gate-Collector Charge		-	12	-	nC
$R_{th(J-C)}$	Thermal Resistance (IGBT Part)	Junction-to-Case	-	1.8	-	$^\circ\text{C/W}$

Diode-Inverter Characteristics $T_C = 25^\circ\text{C}$ unless otherwise noted

Symbol	Parameter	Conditions	Min	Typ	Max	Units
V_F	Diode Forward Voltage	$I_F = 15\text{ A}, V_{GE} = 0\text{ V}$ $T_C = 125^\circ\text{C}$	-	1.5	-	V
t_{rr}	Diode Reverse Recovery Time	$R_{G ON} = 40\ \Omega$ $T_C = 125^\circ\text{C}$	-	282	-	ns
I_{RRM}	Diode Peak Reverse Recovery Current	$L = 500\ \mu\text{H}$ $T_C = 125^\circ\text{C}$	-	15.3	-	A
Q_{rr}	Diode Reverse Recovery Charge	$V_{CE} = 300\text{ V}$ $T_C = 125^\circ\text{C}$	-	1.6	-	μC
E_{rr}	Diode Reverse Recovery Energy	$V_{GE} = 0\text{ V} \sim 15\text{ V}$ $T_C = 125^\circ\text{C}$	-	0.28	-	mJ
$R_{th(J-C)}$	Thermal Resistance (IGBT Part)	$I_{CE} = 15\text{ A}$ Junction-to-Case	-	2.1	-	$^\circ\text{C/W}$

Transistor- Brake Characteristics

Symbol	Parameter	Conditions	Min	Typ	Max	Units
$V_{GE(th)}$	Gate-Emitter Threshold Voltage	$V_{CE} = V_{GE}, I_{CE} = 15\text{ mA}$	-	6.5	-	V
$V_{CE(sat)}$	Collector-Emitter Saturation Voltage	$T_C = 25^\circ\text{C}, I_{CE} = 15\text{ A}, V_{GE} = 15\text{ V}$	-	1.95	-	V
		$T_C = 125^\circ\text{C}, I_{CE} = 15\text{ A}, V_{GE} = 15\text{ V}$	-	2.35	-	V
I_{CES}	Collector-Emitter Cut-off Current	$V_{GE} = 0\text{ V}, V_{CE} = 300\text{ V}$	-	-	250	μA
I_{CES}	Gate-Emitter Leakage Current	$V_{GE} = \pm 20\text{ V}, V_{CE} = 0\text{ V}$	-	-	-	A
C_{iss}	Input Capacitance	$V_{CE} = 50\text{ V}, V_{GE} = 0\text{ V}$ $f = 100\text{ kHz}, T_C = 25^\circ\text{C}$ (Chip level)	-	-	-	nF
C_{oss}	Output Capacitance		-	-	-	nF
C_{rss}	Reverse Transfer Capacitance		-	-	-	nF

Symbol	Parameter	Conditions	Min	Typ	Max	Units
$t_d(\text{on})$	Turn-On Delay Time	$T_C = 125^\circ\text{C}$, $R_{G\text{ ON}} = 40\ \Omega$ $R_{G\text{ OFF}} = 20\ \Omega$, $L = 500\ \mu\text{H}$ $V_{CE} = 300\ \text{V}$, $V_{GE} = 0\ \text{V} \sim 15\ \text{V}$ $I_{CE} = 15\ \text{A}$	-	68	-	ns
t_r	Rise Time		-	54	-	ns
$t_d(\text{off})$	Turn-Off Delay Time		-	86	-	ns
t_f	Fall Time		-	106	-	ns
E_{on}	Turn-On Switching Loss		-	0.65	-	mJ
E_{off}	Turn-Off Switching Loss		-	0.19	-	mJ
E_{ts}	Total Switching Loss		-	0.84	-	mJ
Q_G	Total Gate Charge	$V_{GE} = 0\ \text{V} \sim 15\ \text{V}$	-	43	-	μC
Q_{GE}	Gate-Emitter Charge		-	21	-	μC
Q_{GC}	Gate-Collector Charge		-	12	-	μC
$R_{\text{th(J-C)}}$	Thermal Resistance (IGBT Part)	Junction-to-Case	-	1.8	-	$^\circ\text{C/W}$

Diode-Brake Characteristics $T_C = 25^\circ\text{C}$ unless otherwise noted

Symbol	Parameter	Test Conditions	Min	Typ	Max	Units	
V_F	Diode Forward Voltage	$I_F = 15\ \text{A}$, $V_{GE} = 0\ \text{V}$ $T_C = 125^\circ\text{C}$	-	1.5	-	V	
t_{rr}	Diode Reverse Recovery Time	$R_{G\text{ ON}} = 40\ \Omega$ $L = 500\ \mu\text{H}$ $V_{CE} = 300\ \text{V}$ $V_{GE} = 0\ \text{V} \sim 15\ \text{V}$ $I_{CE} = 15\ \text{A}$	-	415	-	ns	
I_{RRM}	Diode Peak Reverse Recovery Current		$T_C = 125^\circ\text{C}$	-	11.3	-	A
Q_{rr}	Diode Reverse Recovery Charge		$T_C = 125^\circ\text{C}$	-	1.6	-	μC
E_{rr}	Diode Reverse Recovery Energy		$T_C = 125^\circ\text{C}$	-	0.33	-	mJ
$R_{\text{th(J-C)}}$	Thermal Resistance (IGBT Part)	Junction-to-Case	-	2.1	2.5	$^\circ\text{C/W}$	

NTC thermistar Characteristics

Symbol	Parameter	Test Conditions	Min	Typ	Max	Units
R_{25}	Resistance	$T_C = 25^\circ\text{C}$	-	4.7	-	k Ω
P	Power	$T_C = 25^\circ\text{C}$	-	210	-	mW
$B_{25/100}$	B Constant	$T_C = 25^\circ\text{C}$, $\pm 3\%$ tolerance	-	3650	-	K

* This specifications may not be considered as an assurance of characteristics and may not have same characteristics in case of using different test systems from @LSIS. We therefore strongly recommend prior consultation of our engineers.

LEC15G604

Input rectifier

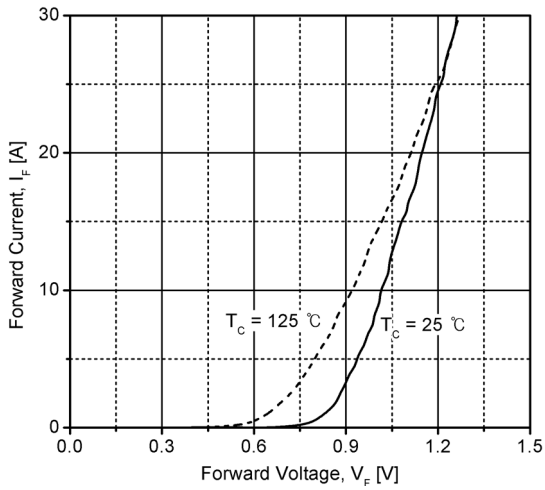

Fig 1. Typical Diode Forward Characteristics

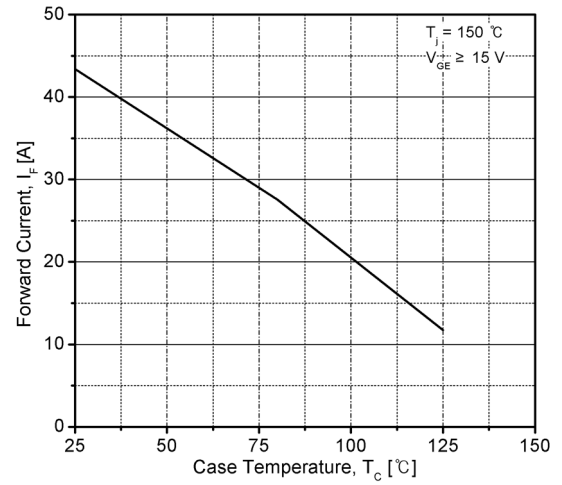

Fig 2. Case Temperature vs. Forward Current

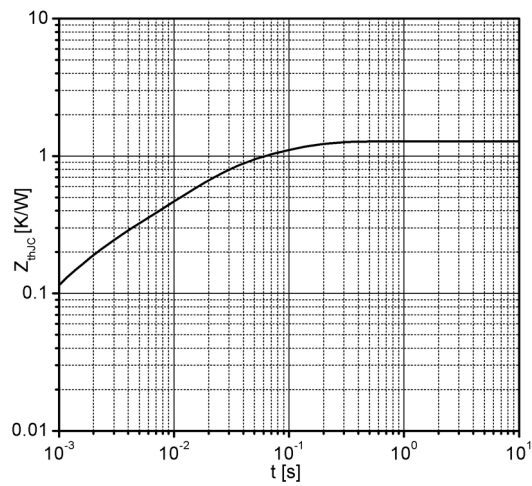

Fig 3. Typical Diode Thermal Impedance

Transistor-inverter/Diode-Inverter

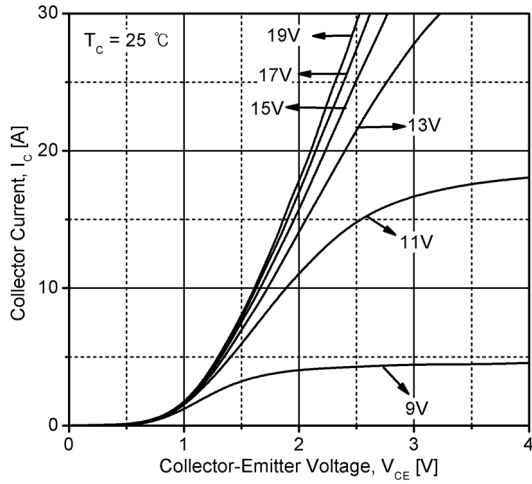

Fig 4. Typical IGBT Output Characteristics

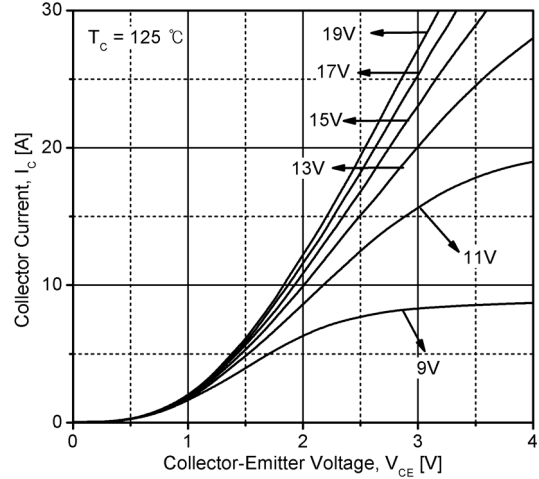

Fig 5. Typical IGBT Output Characteristics

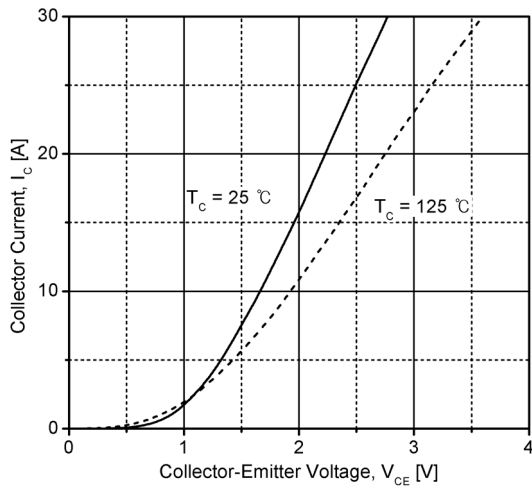

Fig 6. Typical IGBT Output Characteristics

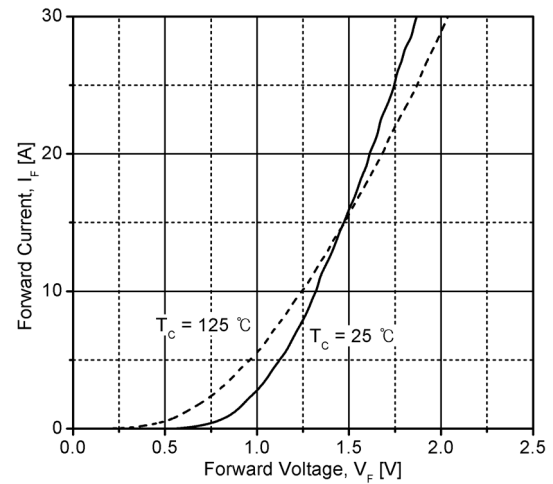

Fig 7. Typical Diode Forward Characteristics

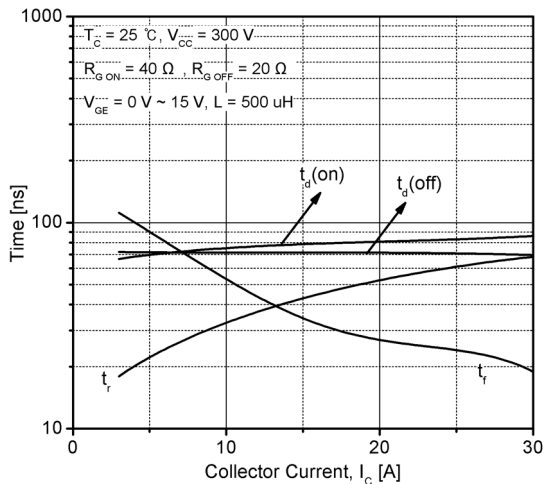

Fig 8. Typical Switching Time vs. Collector Current

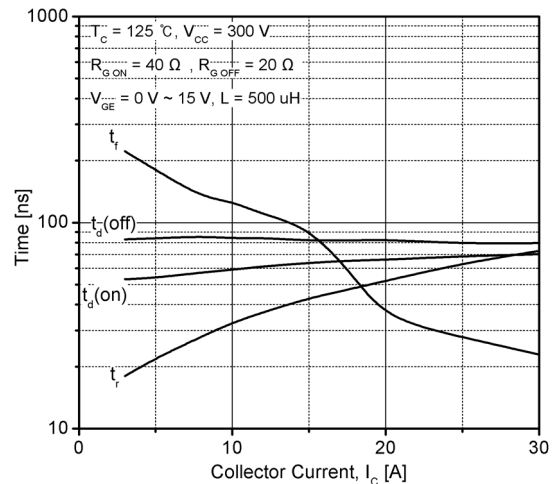

Fig 9. Typical Switching Time vs. Collector Current

LEC15G604

Transistor-inverter/Diode-Inverter

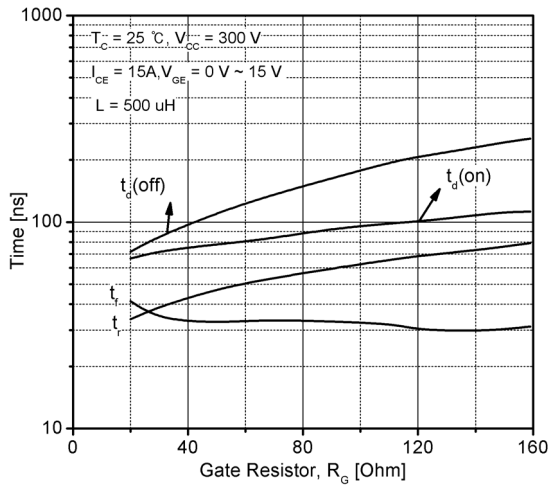

Fig 10. Typical Switching Time vs. Gate Resistor

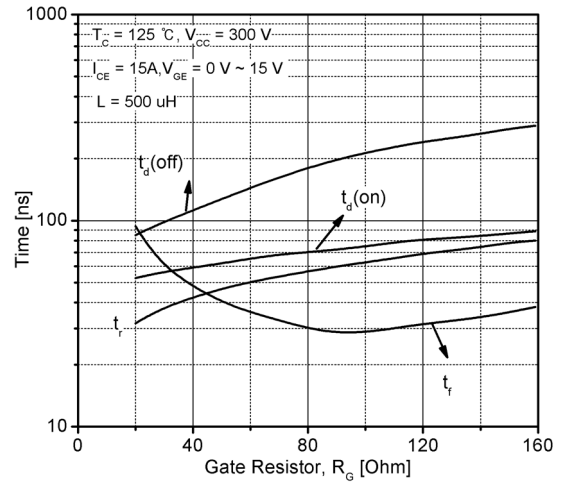

Fig 11. Typical Switching Time vs. Gate Resistor

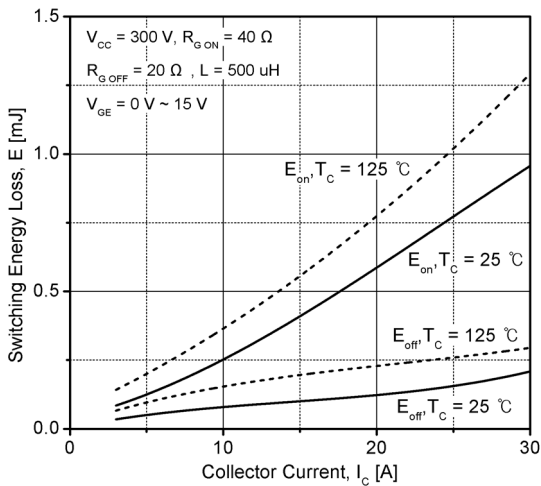

Fig 12. Typical IGBT Switching Loss

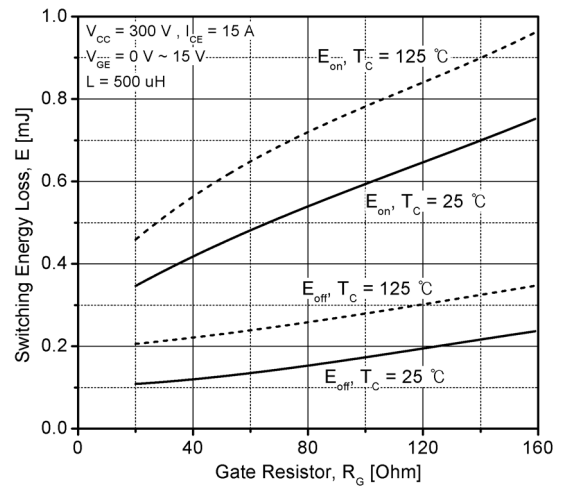

Fig 13. Typical IGBT Switching Loss

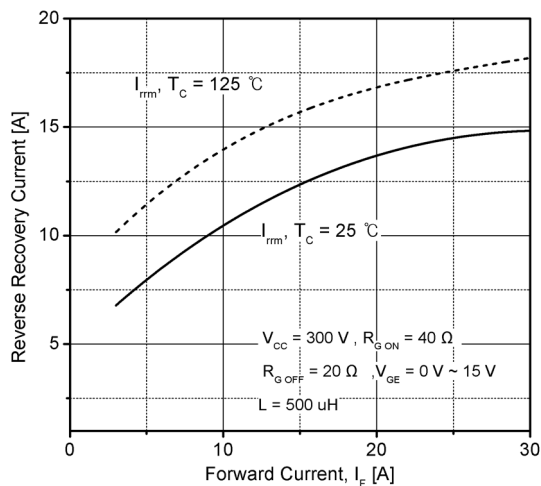

Fig 14. Typical Recovery Characteristics of Diode

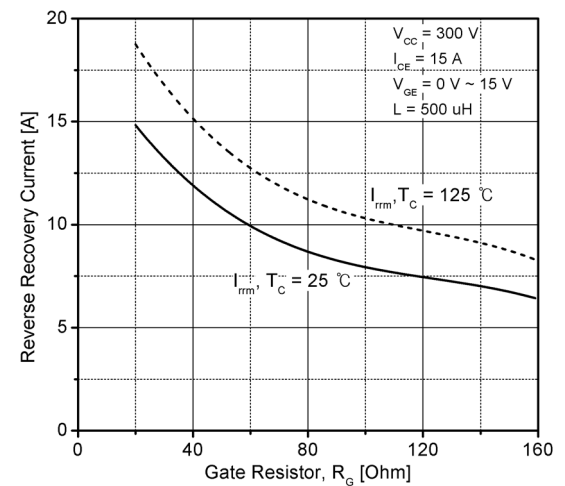

Fig 15. Typical Recovery Characteristics of Diode

Transistor-inverter/Diode-Inverter

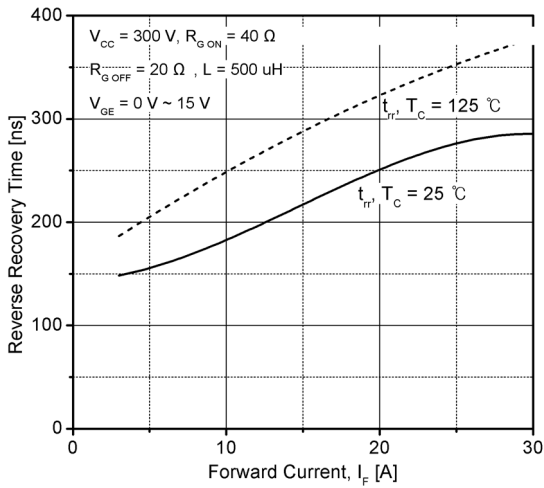

Fig 16. Typical Recovery Characteristics of Diode

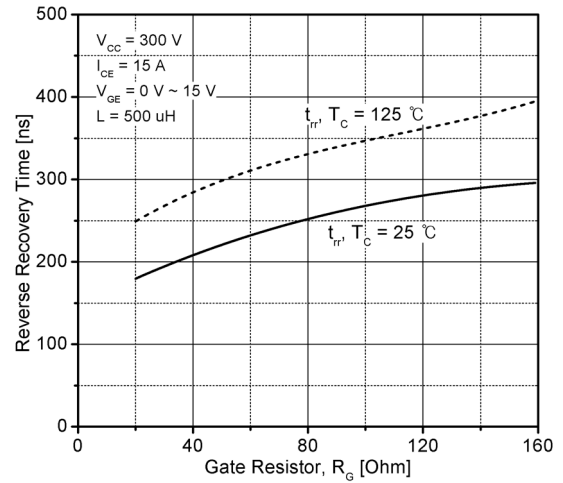

Fig 17. Typical Recovery Characteristics of Diode

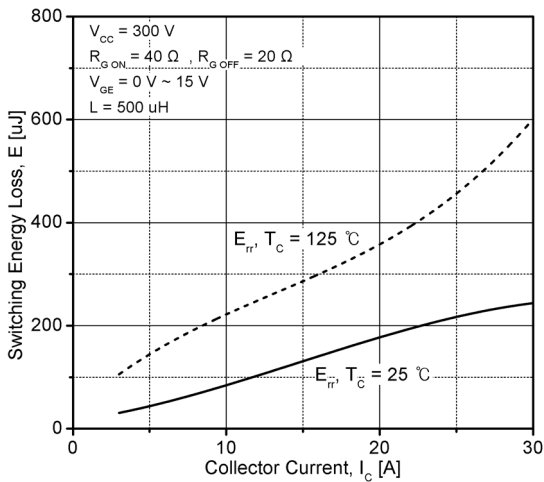

Fig 18. Typical Diode Switching Loss

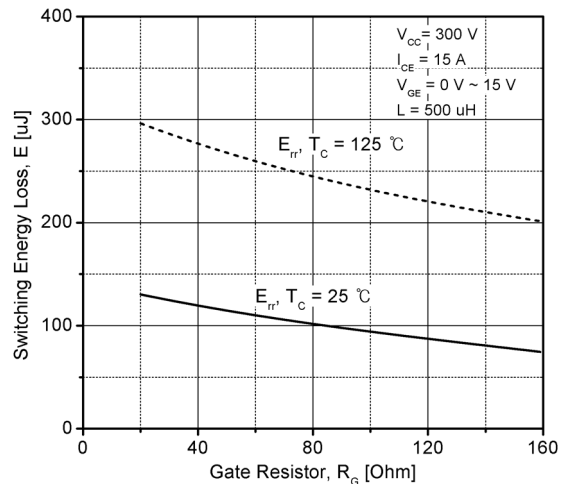

Fig 19. Typical Diode Switching Loss

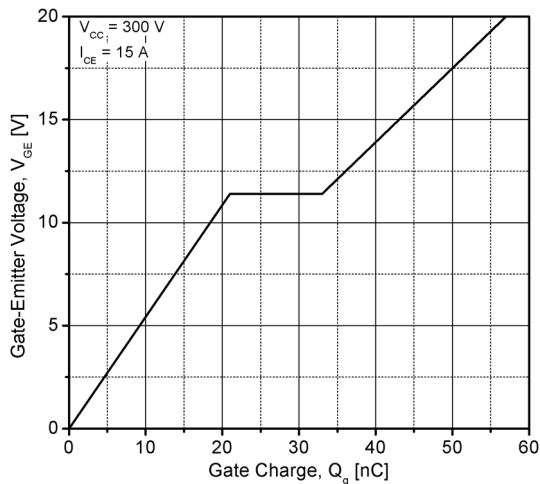

Fig 20. Typical Gate Charge Characteristics

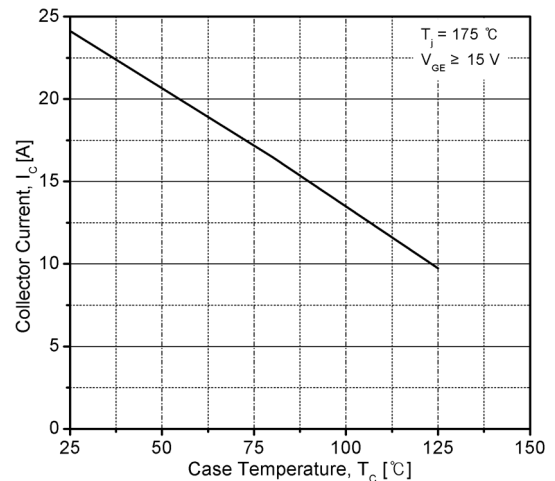

Fig 21. Case Temperature vs. Collector Current

LEC15G604

Transistor-inverter/Diode-Inverter

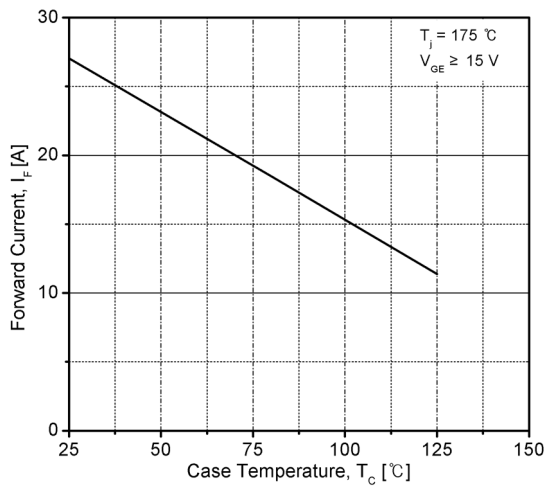

Fig 22. Case Temperature vs. Forward Current

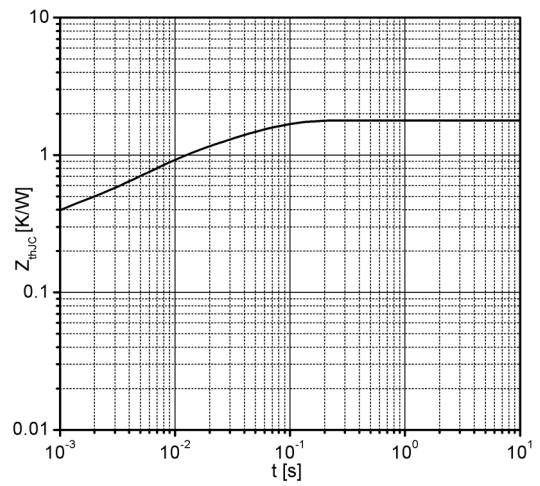

Fig 23. Typical IGBT Thermal Impedance

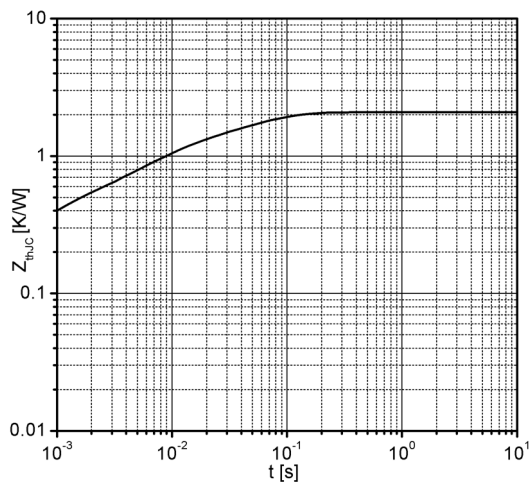

Fig 24. Typical Diode Thermal Impedance

Transistor-Brake/Diode-Brake

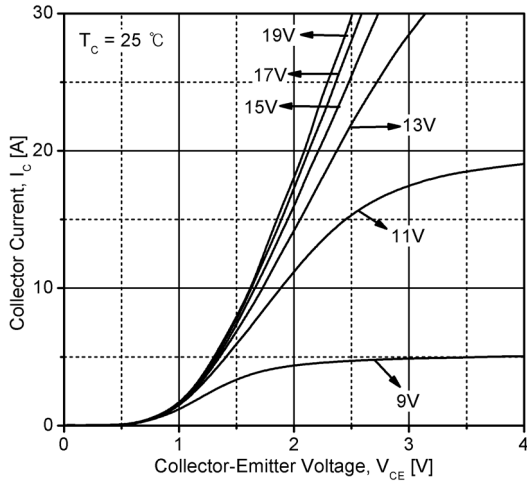

Fig 25. Typical IGBT Output Characteristics

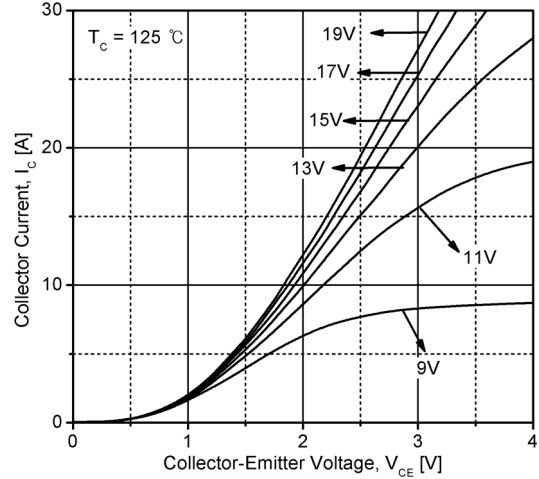

Fig 26. Typical IGBT Output Characteristics

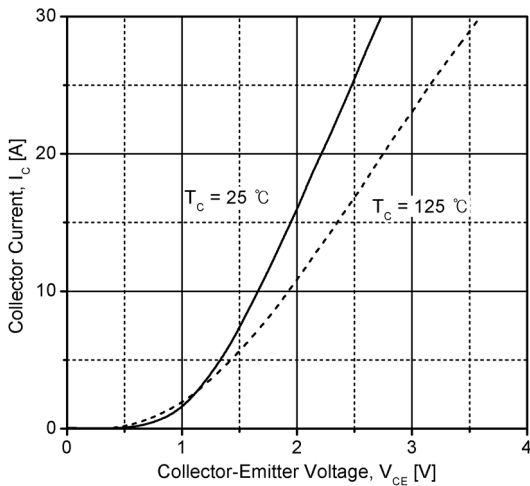

Fig 27. Typical IGBT Output Characteristics

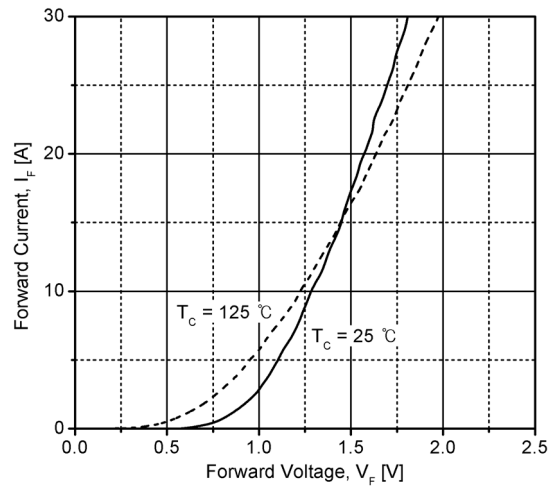

Fig 28. Typical Diode Forward Characteristics

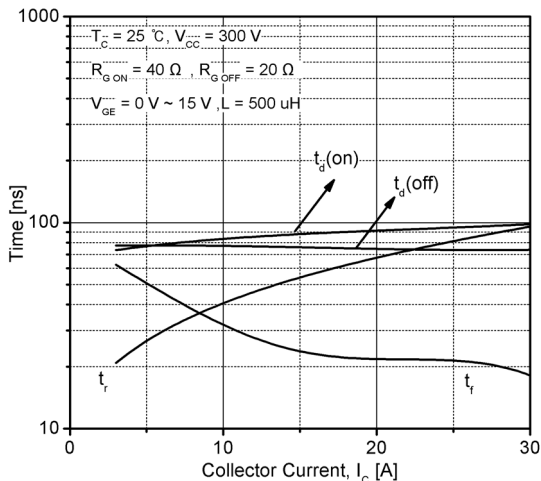

Fig 29. Typical Switching Time vs. Collector Current

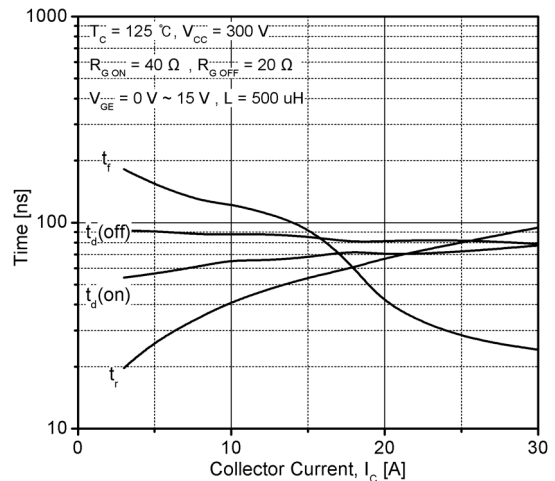

Fig 30. Typical Switching Time vs. Collector Current

LEC15G604

Transistor-Brake/Diode-Brake

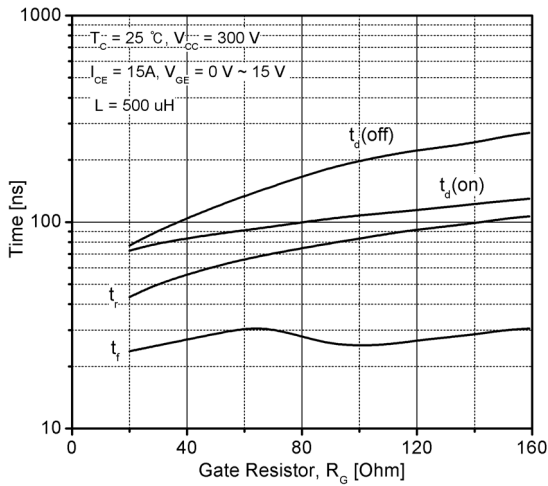

Fig 31. Typical Switching Time vs. Gate Resistor

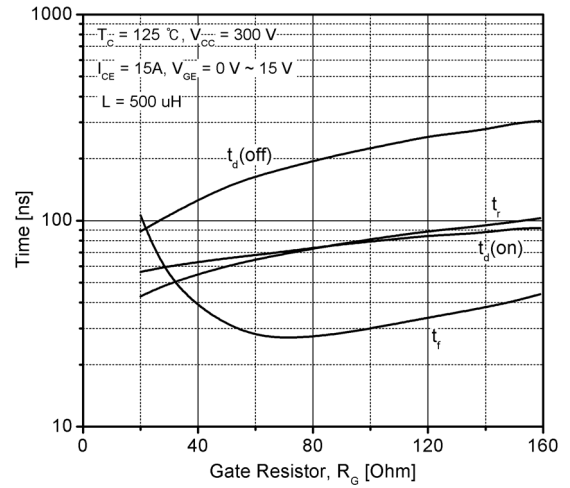

Fig 32. Typical Switching Time vs. Gate Resistor

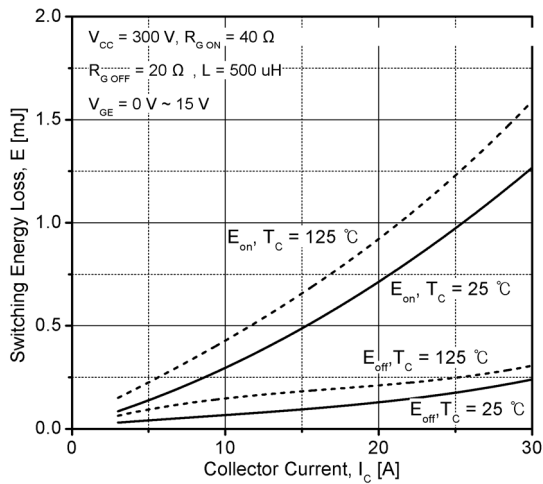

Fig 33. Typical IGBT Switching Loss

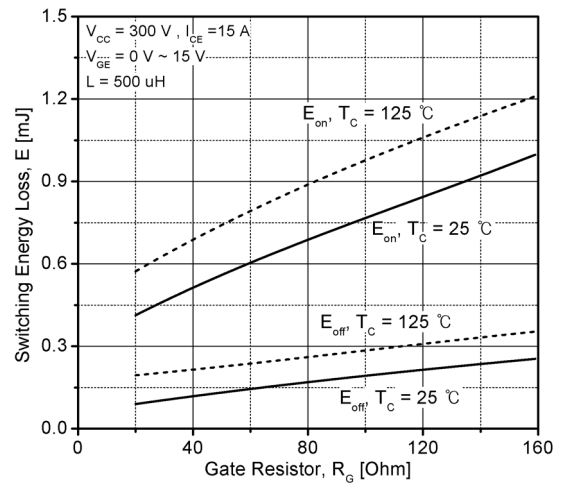

Fig 34. Typical IGBT Switching Loss

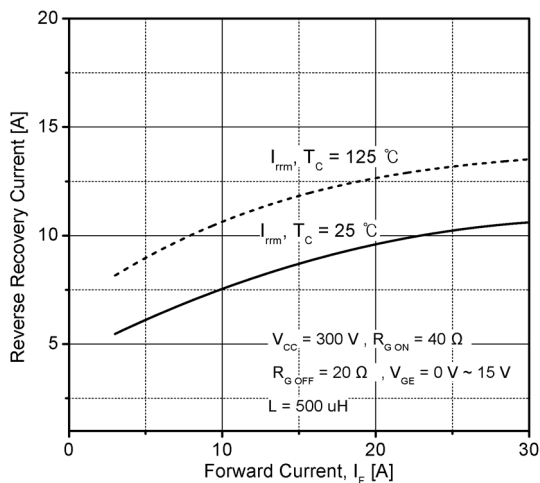

Fig 35. Typical Recovery Characteristics of Diode

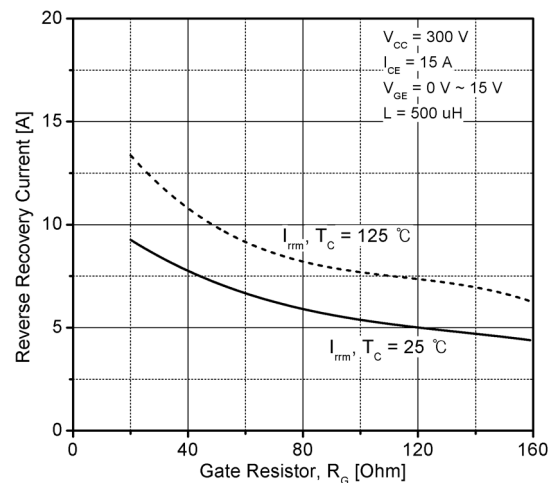

Fig 36. Typical Recovery Characteristics of Diode

Transistor-Brake/Diode-Brake

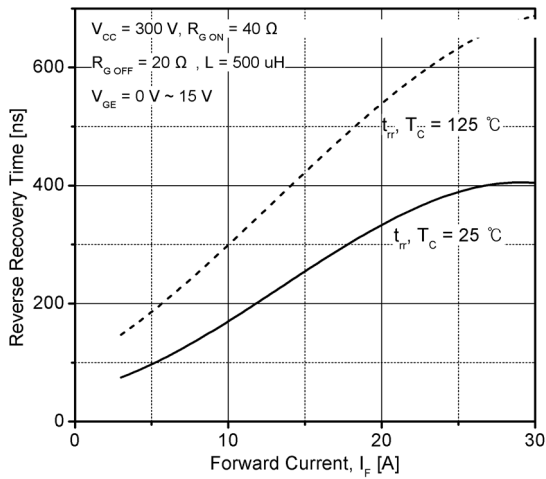

Fig 37. Typical Recovery Characteristics of Diode

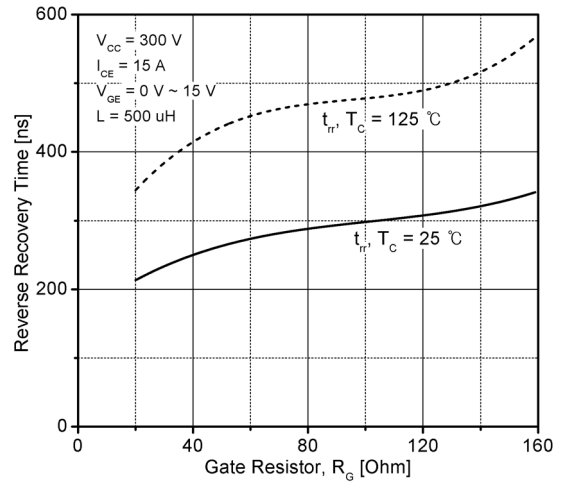

Fig 38. Typical Recovery Characteristics of Diode

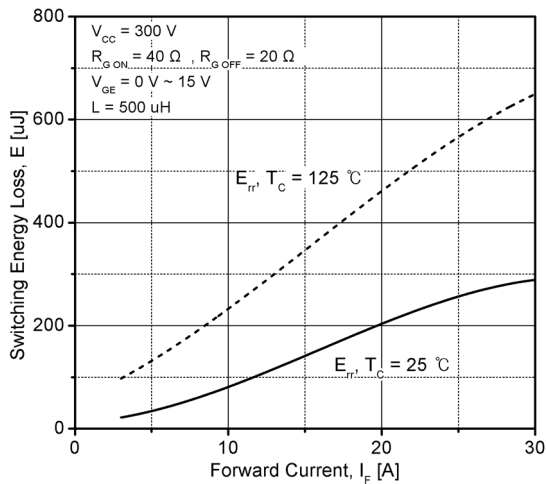

Fig 39. Typical Diode Switching Loss

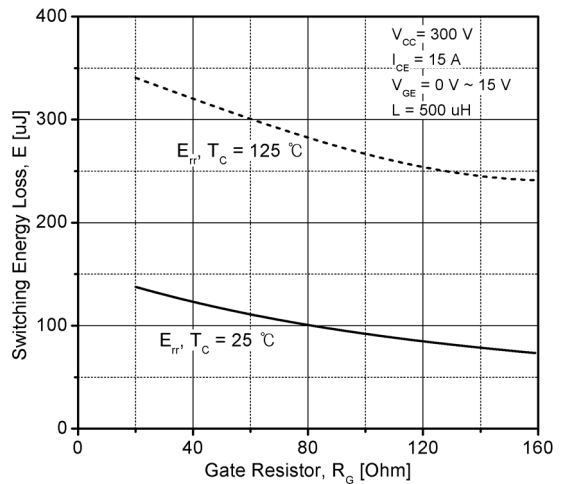

Fig 40. Typical Diode Switching Loss

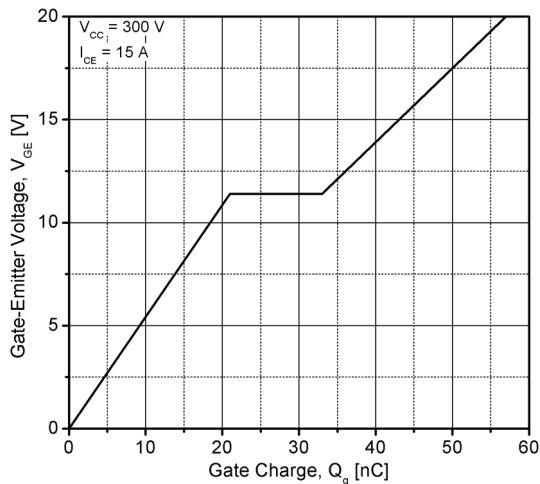

Fig 41. Typical Gate Charge Characteristics

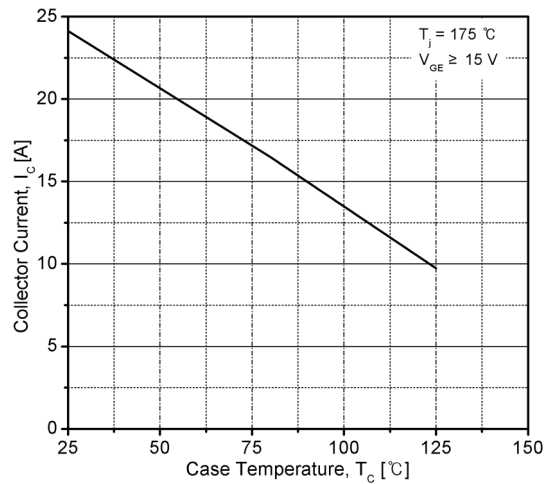

Fig 42. Case Temperature vs. Collector Current

LEC15G604

Transistor-Brake/Diode-Brake

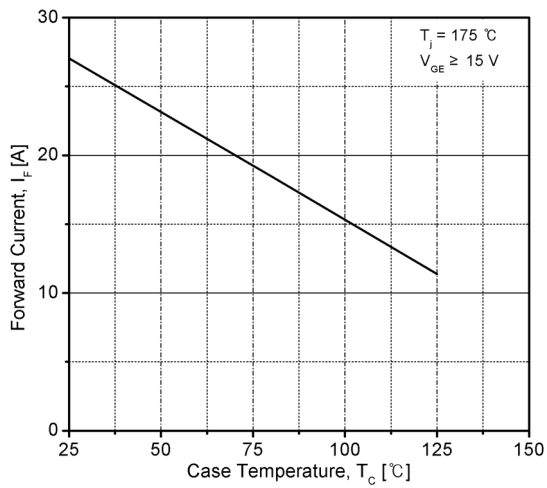

Fig 43. Case Temperature vs. Forward Current

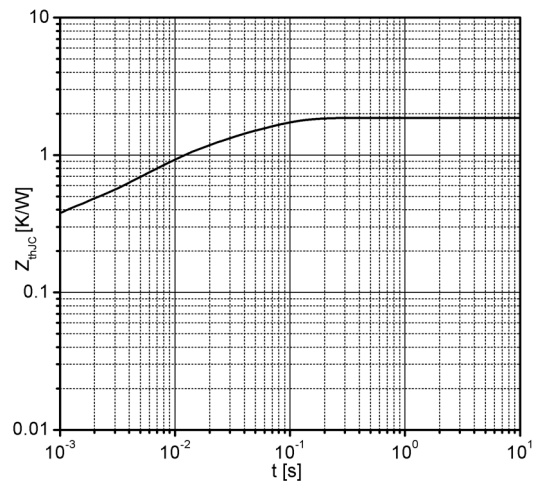

Fig 44. Typical IGBT Thermal Impedance

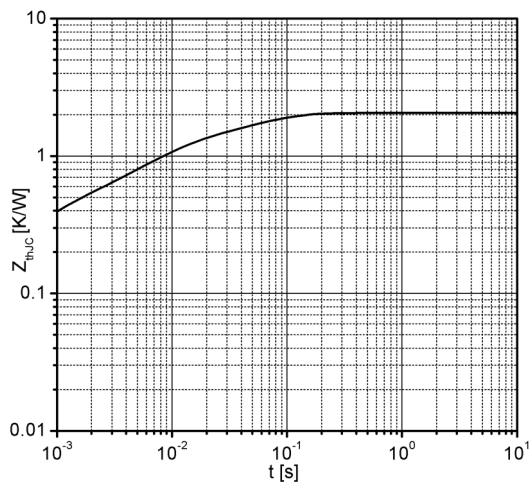

Fig 45. Typical Diode Thermal Impedance

NTC

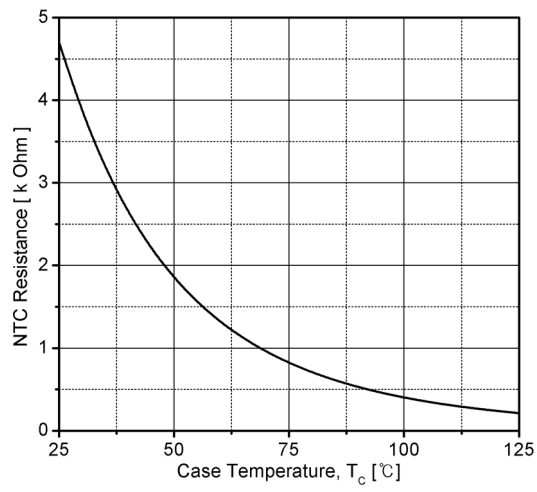

Fig 46. Typical NTC Characteristics

LEC15G604

Package Dimension(Dimension in mm)

