



ON Semiconductor®

FDS6675

Single P-Channel, Logic Level, PowerTrench™ MOSFET

General Description

This P-Channel Logic Level MOSFET is produced using ON Semiconductor's advanced PowerTrench process that has been especially tailored to minimize the on-state resistance and yet maintain low gate charge for superior switching performance.

These devices are well suited for notebook computer applications: load switching and power management, battery charging circuits, and DC/DC conversion.

Features

- -11 A, -30 V. $R_{DS(ON)} = 0.014 \Omega @ V_{GS} = -10 \text{ V}$,
 $R_{DS(ON)} = 0.020 \Omega @ V_{GS} = -4.5 \text{ V}$.
- Low gate charge (30nC typical).
- High performance trench technology for extremely low $R_{DS(ON)}$.
- High power and current handling capability.



SOT-23



SuperSOT™-6



SuperSOT™-8



SO-8



SOT-223



SOIC-16

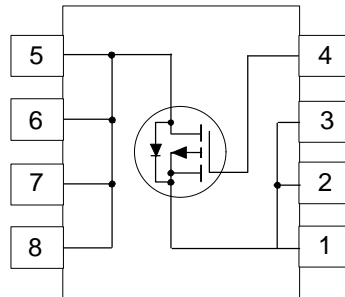
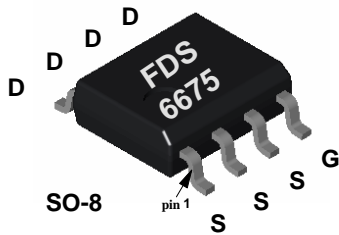

Absolute Maximum Ratings

$T_A = 25^\circ\text{C}$ unless otherwise noted

Symbol	Parameter	FDS6675	Units
V_{DSS}	Drain-Source Voltage	-30	V
V_{GSS}	Gate-Source Voltage	± 20	V
I_D	Drain Current - Continuous (Note 1a)	-11	A
	- Pulsed	-50	
P_D	Power Dissipation for Single Operation (Note 1a)	2.5	W
	(Note 1b)	1.2	
	(Note 1c)	1	
T_J, T_{STG}	Operating and Storage Temperature Range	-55 to 150	$^\circ\text{C}$

THERMAL CHARACTERISTICS

$R_{\theta JA}$	Thermal Resistance, Junction-to-Ambient (Note 1a)	50	$^\circ\text{C}/\text{W}$
$R_{\theta JC}$	Thermal Resistance, Junction-to-Case (Note 1)	25	$^\circ\text{C}/\text{W}$

Electrical Characteristics ($T_A = 25^\circ\text{C}$ unless otherwise noted)

Symbol	Parameter	Conditions	Min	Typ	Max	Units
OFF CHARACTERISTICS						
BV_{DSS}	Drain-Source Breakdown Voltage	$V_{GS} = 0\text{ V}, I_D = -250\ \mu\text{A}$	-30			V
$\Delta BV_{DSS}/\Delta T_J$	Breakdown Voltage Temp. Coefficient	$I_D = -250\ \mu\text{A}$, Referenced to 25°C		-22		$\text{mV}/^\circ\text{C}$
I_{DSS}	Zero Gate Voltage Drain Current	$V_{DS} = -24\text{ V}, V_{GS} = 0\text{ V}$			-1	μA
						-10
I_{GSSF}	Gate - Body Leakage, Forward	$V_{GS} = 20\text{ V}, V_{DS} = 0\text{ V}$			100	nA
I_{GSSR}	Gate - Body Leakage, Reverse	$V_{GS} = -20\text{ V}, V_{DS} = 0\text{ V}$			-100	nA
ON CHARACTERISTICS (Note 2)						
$V_{GS(th)}$	Gate Threshold Voltage	$V_{DS} = V_{GS}, I_D = -250\ \mu\text{A}$	-1	-1.7	-3	V
$\Delta V_{GS(th)}/\Delta T_J$	Gate Threshold Voltage Temp. Coefficient	$I_D = 250\ \mu\text{A}$, Referenced to 25°C		4.3		$\text{mV}/^\circ\text{C}$
$R_{DS(on)}$	Static Drain-Source On-Resistance	$V_{GS} = -10\text{ V}, I_D = -11\text{ A}$		0.011	0.014	Ω
					0.016	
		$V_{GS} = -4.5\text{ V}, I_D = -9\text{ A}$		0.015	0.02	
$I_{D(on)}$	On-State Drain Current	$V_{GS} = -10\text{ V}, V_{DS} = -5\text{ V}$	-50			A
g_{FS}	Forward Transconductance	$V_{DS} = -10\text{ V}, I_D = -11\text{ A}$		32		S
DYNAMIC CHARACTERISTICS						
C_{iss}	Input Capacitance	$V_{DS} = -15\text{ V}, V_{GS} = 0\text{ V},$ $f = 1.0\text{ MHz}$		3000		pF
C_{oss}	Output Capacitance			870		pF
C_{rss}	Reverse Transfer Capacitance			360		pF
SWITCHING CHARACTERISTICS (Note 2)						
$t_{D(on)}$	Turn - On Delay Time	$V_{DS} = -15\text{ V}, I_D = -1\text{ A}$ $V_{GEN} = -10\text{ V}, R_{GEN} = 6\ \Omega$		12	22	ns
t_r	Turn - On Rise Time			16	27	ns
$t_{D(off)}$	Turn - Off Delay Time			50	80	ns
t_f	Turn - Off Fall Time			100	140	ns
Q_g	Total Gate Charge	$V_{DS} = -15\text{ V}, I_D = -11\text{ A},$ $V_{GS} = -5\text{ V}$		30	42	nC
Q_{gs}	Gate-Source Charge			9		nC
Q_{gd}	Gate-Drain Charge			11		nC
DRAIN-SOURCE DIODE CHARACTERISTICS AND MAXIMUM RATINGS						
I_S	Maximum Continuous Drain-Source Diode Forward Current				-2.1	A
V_{SD}	Drain-Source Diode Forward Voltage	$V_{GS} = 0\text{ V}, I_S = -2.1\text{ A}$ (Note 2)		-0.72	-1.2	V

Notes:

- $R_{\theta JA}$ is the sum of the junction-to-case and case-to-ambient thermal resistance where the case thermal reference is defined as the solder mounting surface of the drain pins. $R_{\theta JC}$ is guaranteed by design while $R_{\theta CA}$ is determined by the user's board design.

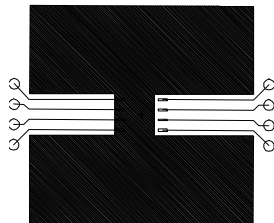

a. $50^\circ\text{C}/\text{W}$ on a 0.5 in^2 pad of 2oz copper.

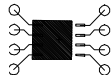

b. $105^\circ\text{C}/\text{W}$ on a 0.02 in^2 pad of 2oz copper.

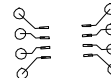

c. $125^\circ\text{C}/\text{W}$ on a 0.003 in^2 pad of 2oz copper.

Scale 1 : 1 on letter size paper

- Pulse Test: Pulse Width $\leq 300\ \mu\text{s}$, Duty Cycle $\leq 2.0\%$.

Typical Electrical Characteristics

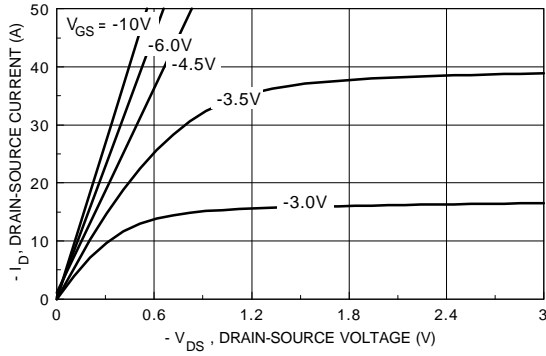

Figure 1. On-Region Characteristics.

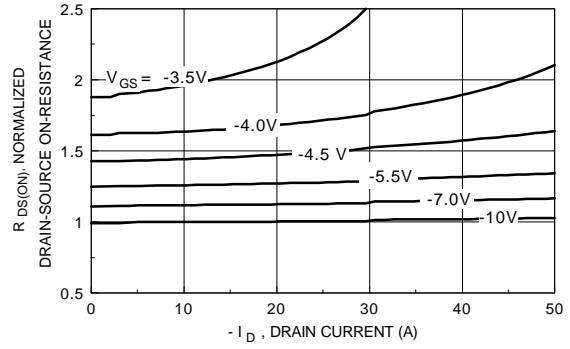

Figure 2. On-Resistance Variation with Drain Current and Gate Voltage.

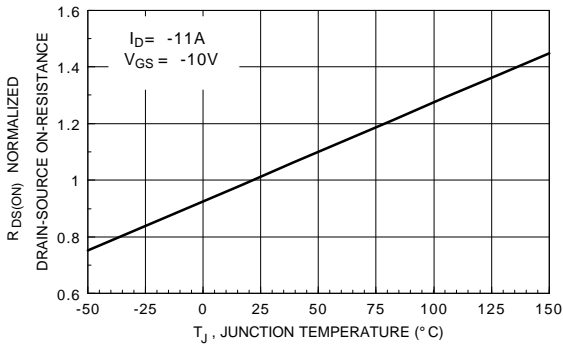

Figure 3. On-Resistance Variation with Temperature.

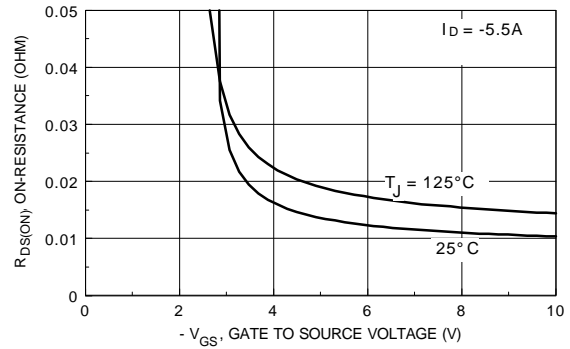

Figure 4. On-Resistance Variation with Gate-to-Source Voltage.

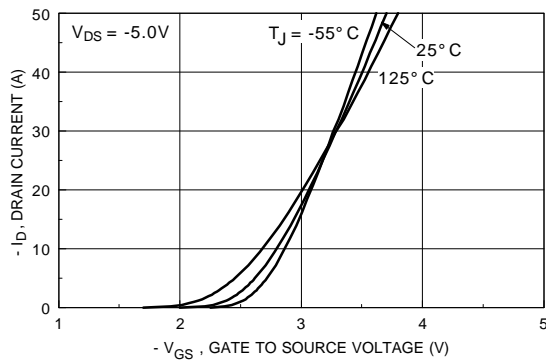

Figure 5. Transfer Characteristics.

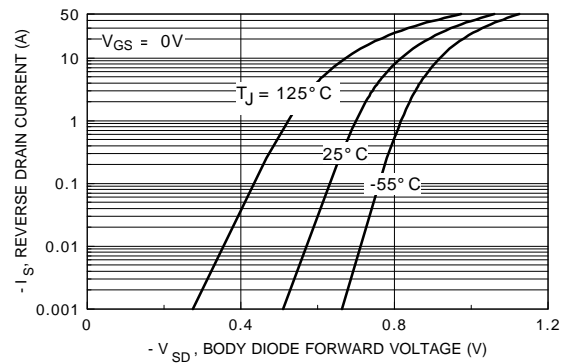

Figure 6. Body Diode Forward Voltage Variation with Source Current and Temperature.

Typical Electrical Characteristics (continued)

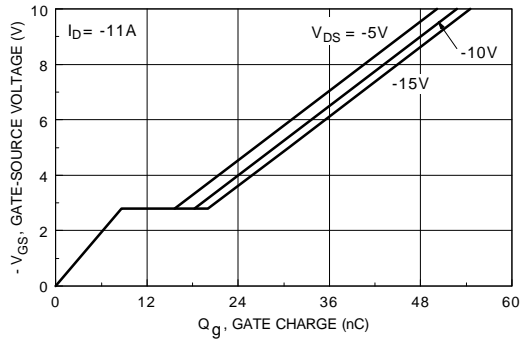

Figure 7. Gate Charge Characteristics.

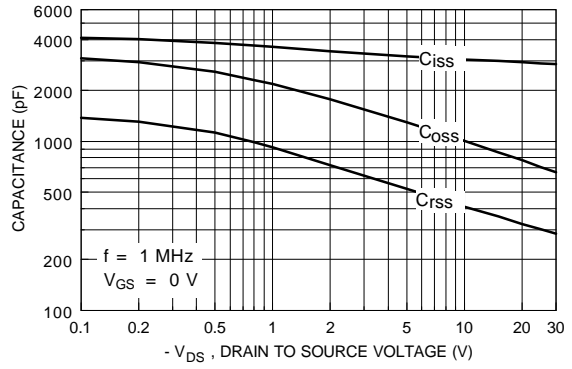

Figure 8. Capacitance Characteristics.

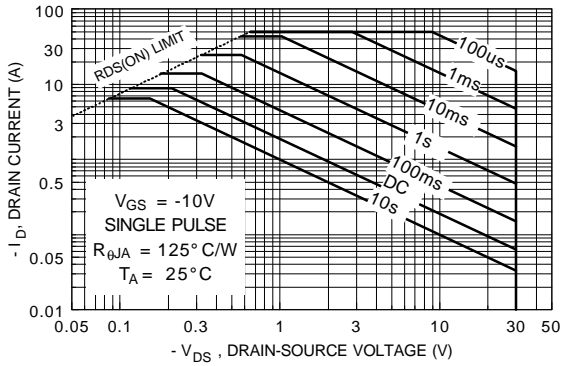

Figure 9. Maximum Safe Operating Area.

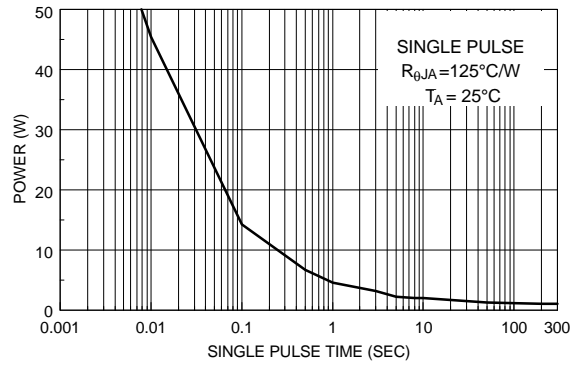

Figure 10. Single Pulse Maximum Power Dissipation.

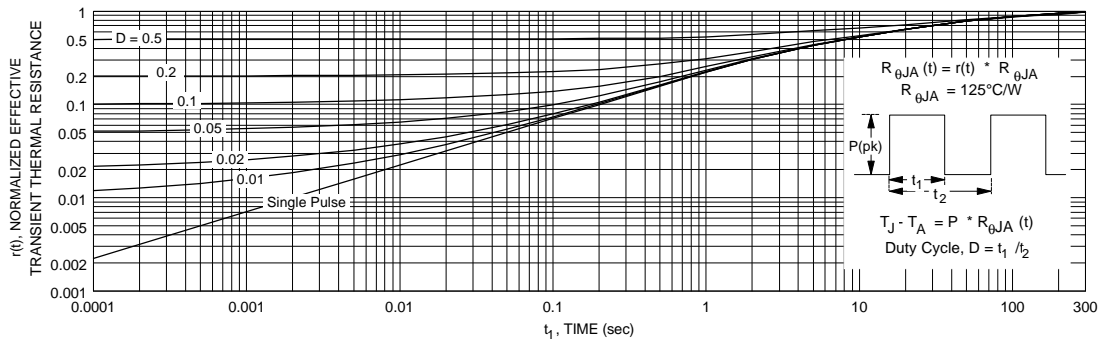

Figure 11. Transient Thermal Response Curve.

Thermal characterization performed using the conditions described in Note 1c.
Transient thermal response will change depending on the circuit board design.

SO-8 Tape and Reel Data and Package Dimensions



SOIC(8lds) Packaging Configuration: Figure 1.0

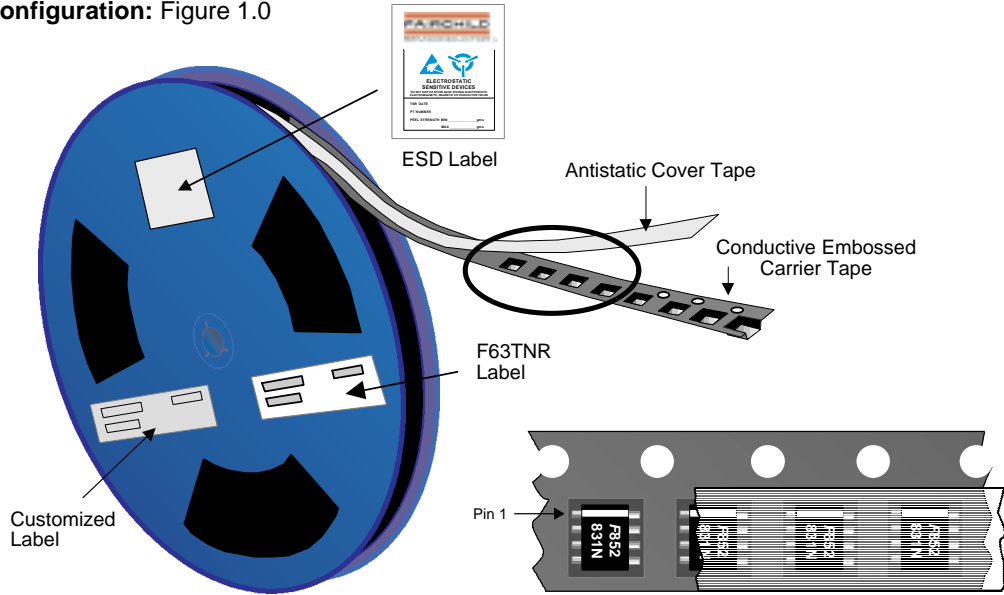

SOIC (8lds) Packaging Information				
Packaging Option	Standard (no flow code)	L86Z	S62Z	D84Z
Packaging type	TNR	Rail/Tube	Bag	TNR
Qty per Reel/Tube/Bag	2,500	95	200	500
Reel Size	13" Dia	-	-	7" Dia
Box Dimension (mm)	343x64x343	530x130x83	76x102x127	184x187x47
Max qty per Box	5,000	30,000	1,000	2,500
Weight per unit (gm)	0.0774	0.0774	0.0774	0.0774
Weight per Reel (kg)	0.6060	-	-	0.1182
Note/Comments			Bulk	

SOIC-8 Unit Orientation

F63TNR Label sample

LOT: CBVK741B019	QTY: 2500
FSID: FDS9953A	SPEC:
DIC1: D9842	QTY1:
DIC2:	QTY2:
SPEC REV: CPN:	QARV:
	(F63TNR)2

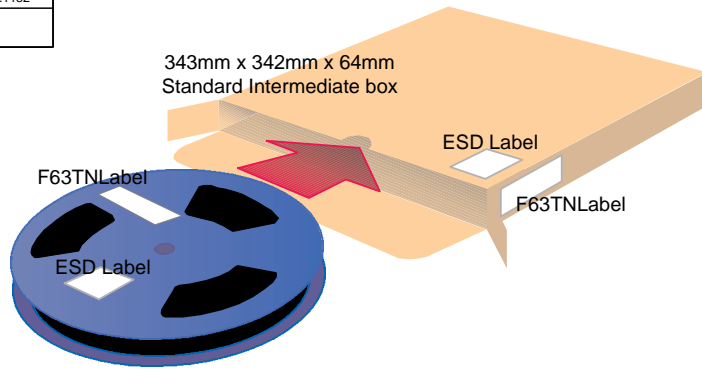

SOIC(8lds) Tape Leader and Trailer Configuration: Figure 2.0

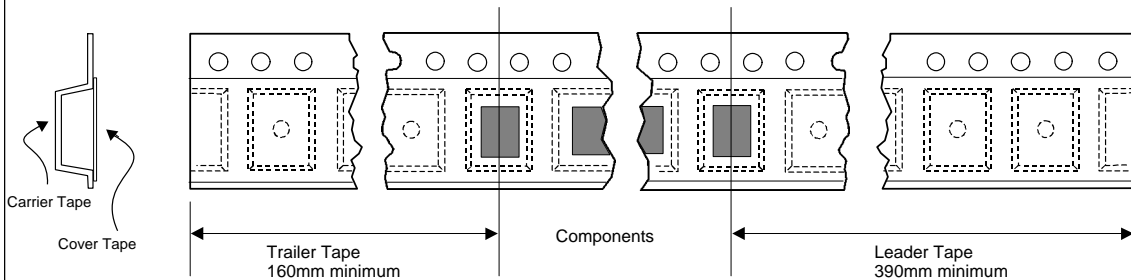

SO-8 Tape and Reel Data and Package Dimensions, continued

SOIC(8lds) Embossed Carrier Tape Configuration: Figure 3.0

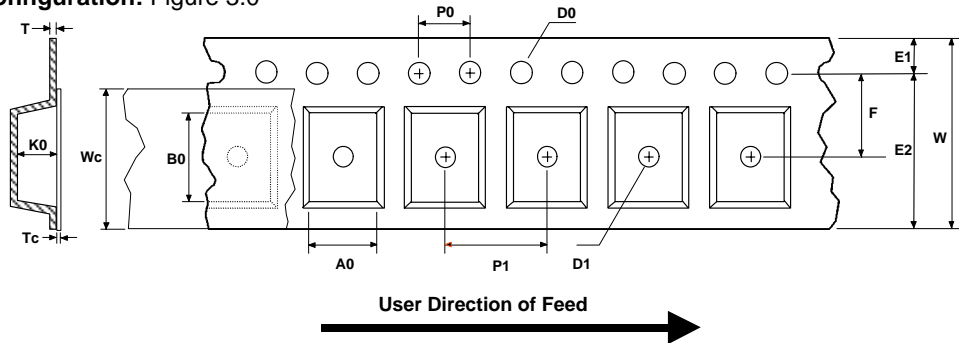

Dimensions are in millimeter														
Pkg type	A0	B0	W	D0	D1	E1	E2	F	P1	P0	K0	T	Wc	Tc
SOIC(8lds) (12mm)	6.50 +/-0.10	5.30 +/-0.10	12.0 +/-0.3	1.55 +/-0.05	1.60 +/-0.10	1.75 +/-0.10	10.25 min	5.50 +/-0.05	8.0 +/-0.1	4.0 +/-0.1	2.1 +/-0.10	0.450 +/- 0.150	9.2 +/-0.3	0.06 +/-0.02

Notes: A0, B0, and K0 dimensions are determined with respect to the EIA/Jedec RS-481 rotational and lateral movement requirements (see sketches A, B, and C).

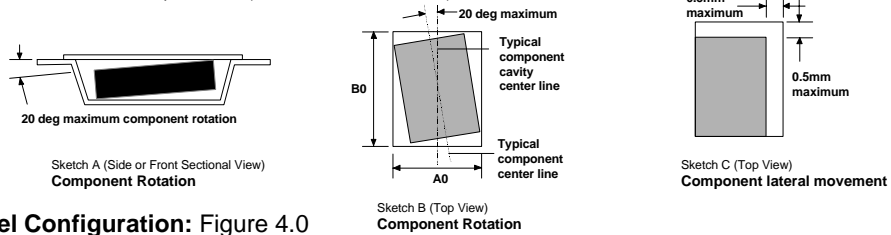

SOIC(8lds) Reel Configuration: Figure 4.0

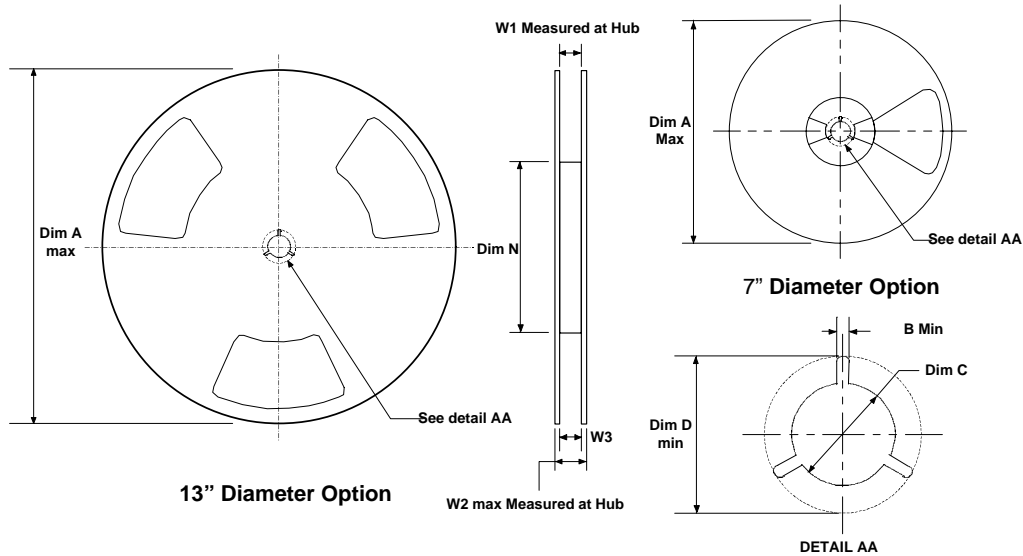

Dimensions are in inches and millimeters									
Tape Size	Reel Option	Dim A	Dim B	Dim C	Dim D	Dim N	Dim W1	Dim W2	Dim W3 (LSL-USL)
12mm	7" Dia	7.00 177.8	0.059 1.5	512 +0.020/-0.008 13 +0.5/-0.2	0.795 20.2	5.906 150	0.488 +0.078/-0.000 12.4 +2/0	0.724 18.4	0.469 - 0.606 11.9 - 15.4
12mm	13" Dia	13.00 330	0.059 1.5	512 +0.020/-0.008 13 +0.5/-0.2	0.795 20.2	7.00 178	0.488 +0.078/-0.000 12.4 +2/0	0.724 18.4	0.469 - 0.606 11.9 - 15.4

SO-8 Tape and Reel Data and Package Dimensions, continued

SOIC-8 (FS PKG Code S1)

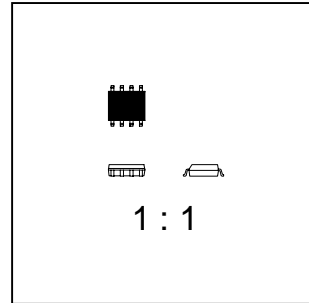
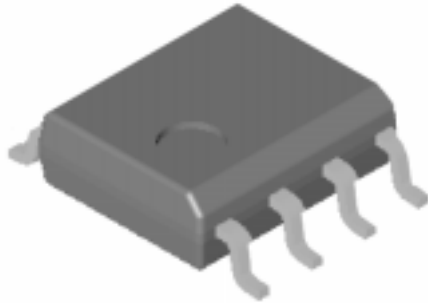

Scale 1:1 on letter size paper

Dimensions shown below are in:
inches [millimeters]

Part Weight per unit (gram): 0.0774

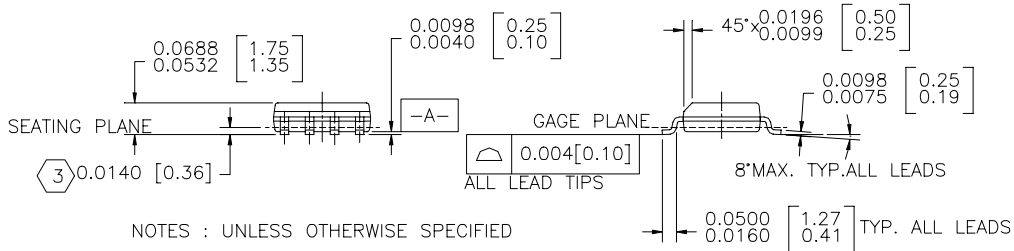
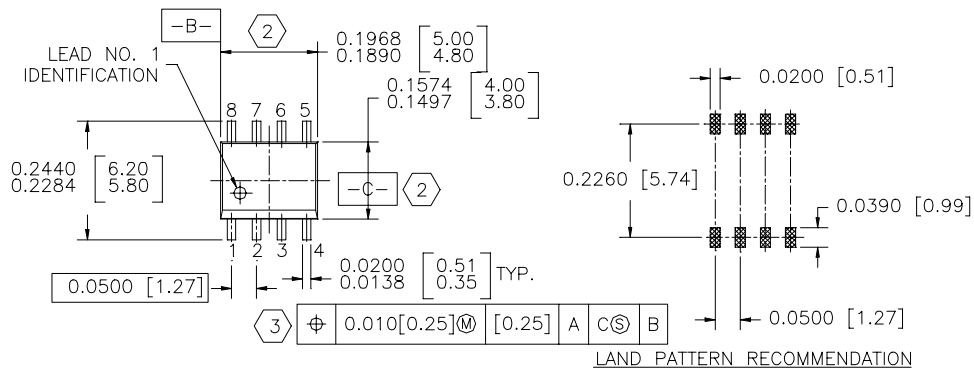

NOTES : UNLESS OTHERWISE SPECIFIED

1. STANDARD LEAD FINISH:
200 MICROINCHES / 5.08 MICRONS MINIMUM
LEAD / TIN (SOLDER) ON COPPER.

SO 0.150 WIDE 8 LEADS

(2) THESE DIMENSIONS DO NOT INCLUDE MOLD FLASH

(3) MAXIMUM LEAD 0.024 [0.609]

ON Semiconductor and  are trademarks of Semiconductor Components Industries, LLC dba ON Semiconductor or its subsidiaries in the United States and/or other countries. ON Semiconductor owns the rights to a number of patents, trademarks, copyrights, trade secrets, and other intellectual property. A listing of ON Semiconductor's product/patent coverage may be accessed at www.onsemi.com/site/pdf/Patent-Marking.pdf. ON Semiconductor reserves the right to make changes without further notice to any products herein. ON Semiconductor makes no warranty, representation or guarantee regarding the suitability of its products for any particular purpose, nor does ON Semiconductor assume any liability arising out of the application or use of any product or circuit, and specifically disclaims any and all liability, including without limitation special, consequential or incidental damages. Buyer is responsible for its products and applications using ON Semiconductor products, including compliance with all laws, regulations and safety requirements or standards, regardless of any support or applications information provided by ON Semiconductor. "Typical" parameters which may be provided in ON Semiconductor data sheets and/or specifications can and do vary in different applications and actual performance may vary over time. All operating parameters, including "Typicals" must be validated for each customer application by customer's technical experts. ON Semiconductor does not convey any license under its patent rights nor the rights of others. ON Semiconductor products are not designed, intended, or authorized for use as a critical component in life support systems or any FDA Class 3 medical devices or medical devices with a same or similar classification in a foreign jurisdiction or any devices intended for implantation in the human body. Should Buyer purchase or use ON Semiconductor products for any such unintended or unauthorized application, Buyer shall indemnify and hold ON Semiconductor and its officers, employees, subsidiaries, affiliates, and distributors harmless against all claims, costs, damages, and expenses, and reasonable attorney fees arising out of, directly or indirectly, any claim of personal injury or death associated with such unintended or unauthorized use, even if such claim alleges that ON Semiconductor was negligent regarding the design or manufacture of the part. ON Semiconductor is an Equal Opportunity/Affirmative Action Employer. This literature is subject to all applicable copyright laws and is not for resale in any manner.

PUBLICATION ORDERING INFORMATION

LITERATURE FULFILLMENT:

Literature Distribution Center for ON Semiconductor
19521 E. 32nd Pkwy, Aurora, Colorado 80011 USA
Phone: 303-675-2175 or 800-344-3860 Toll Free USA/Canada
Fax: 303-675-2176 or 800-344-3867 Toll Free USA/Canada
Email: orderlit@onsemi.com

N. American Technical Support: 800-282-9855 Toll Free
USA/Canada
Europe, Middle East and Africa Technical Support:
Phone: 421 33 790 2910
Japan Customer Focus Center
Phone: 81-3-5817-1050

ON Semiconductor Website: www.onsemi.com
Order Literature: <http://www.onsemi.com/orderlit>
For additional information, please contact your local
Sales Representative