

## N - CHANNEL ENHANCEMENT MODE POWER MOS TRANSISTORS

TYPE	V <sub>DSS</sub>	R <sub>DS(on)</sub>	I <sub>D</sub>
BUZ72A	100 V	< 0.25 Ω	11 A

- TYPICAL R<sub>DS(on)</sub> = 0.23 Ω
- AVALANCHE RUGGED TECHNOLOGY
- 100% AVALANCHE TESTED
- REPETITIVE AVALANCHE DATA AT 100°C
- LOW GATE CHARGE
- HIGH CURRENT CAPABILITY
- 175°C OPERATING TEMPERATURE

### APPLICATIONS

- HIGH CURRENT, HIGH SPEED SWITCHING
- SOLENOID AND RELAY DRIVERS
- REGULATORS
- DC-DC & DC-AC CONVERTERS
- MOTOR CONTROL, AUDIO AMPLIFIERS
- AUTOMOTIVE ENVIRONMENT (INJECTION, ABS, AIR-BAG, LAMPDRIVERS, Etc.)

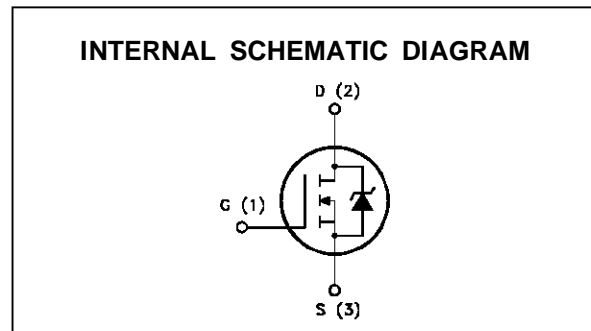
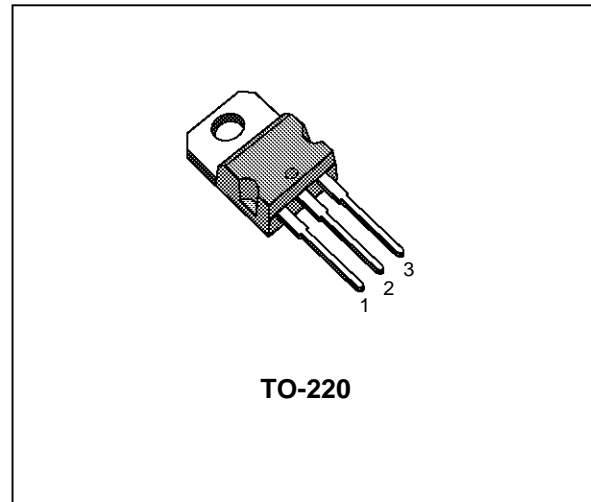

### ABSOLUTE MAXIMUM RATINGS

Symbol	Parameter	Value	Unit
V <sub>DS</sub>	Drain-source Voltage (V <sub>GS</sub> = 0)	100	V
V <sub>DGR</sub>	Drain- gate Voltage (R <sub>GS</sub> = 20 kΩ)	100	V
V <sub>GS</sub>	Gate-source Voltage	± 20	V
I <sub>D</sub>	Drain Current (continuous) at T <sub>c</sub> = 25 °C	11	A
I <sub>DM</sub>	Drain Current (pulsed)	44	A
P <sub>tot</sub>	Total Dissipation at T <sub>c</sub> = 25 °C	70	W
T <sub>stg</sub>	Storage Temperature	-65 to 175	°C
T <sub>j</sub>	Max. Operating Junction Temperature	175	°C
	DIN Humidity Category (DIN 40040)	E	
	IEC Climatic Category (DIN IEC 68-1)	55/150/56	

## BUZ72A

### THERMAL DATA

$R_{thj-case}$	Thermal Resistance Junction-case	Max	2.14	$^{\circ}\text{C}/\text{W}$
$R_{thj-amb}$	Thermal Resistance Junction-ambient	Max	62.5	$^{\circ}\text{C}/\text{W}$

### AVALANCHE CHARACTERISTICS

Symbol	Parameter	Value	Unit
$I_{AR}$	Avalanche Current, Repetitive or Not-Repetitive (pulse width limited by $T_j$ max, $\delta < 1\%$ )	11	A
$E_{AS}$	Single Pulse Avalanche Energy (starting $T_j = 25^{\circ}\text{C}$ , $I_D = I_{AR}$ , $V_{DD} = 25\text{ V}$ )	36	mJ
$E_{AR}$	Repetitive Avalanche Energy (pulse width limited by $T_j$ max, $\delta < 1\%$ )	9	mJ
$I_{AR}$	Avalanche Current, Repetitive or Not-Repetitive ( $T_c = 100^{\circ}\text{C}$ , pulse width limited by $T_j$ max, $\delta < 1\%$ )	7	A

### ELECTRICAL CHARACTERISTICS ( $T_{case} = 25^{\circ}\text{C}$ unless otherwise specified)

OFF

Symbol	Parameter	Test Conditions	Min.	Typ.	Max.	Unit
$V_{(BR)DSS}$	Drain-source Breakdown Voltage	$I_D = 250\ \mu\text{A}$ $V_{GS} = 0$	100			V
$I_{DSS}$	Zero Gate Voltage Drain Current ( $V_{GS} = 0$ )	$V_{DS} = \text{Max Rating}$ $V_{DS} = \text{Max Rating}$ $T_j = 125^{\circ}\text{C}$			250 1000	$\mu\text{A}$ $\mu\text{A}$
$I_{GSS}$	Gate-body Leakage Current ( $V_{DS} = 0$ )	$V_{GS} = \pm 20\text{ V}$			$\pm 100$	nA

ON (\*)

Symbol	Parameter	Test Conditions	Min.	Typ.	Max.	Unit
$V_{GS(th)}$	Gate Threshold Voltage	$V_{DS} = V_{GS}$ $I_D = 250\ \mu\text{A}$	2	2.9	4	V
$R_{DS(on)}$	Static Drain-source On Resistance	$V_{GS} = 10\text{ V}$ $I_D = 5\text{ A}$		0.23	0.25	$\Omega$

DYNAMIC

Symbol	Parameter	Test Conditions	Min.	Typ.	Max.	Unit
$g_{fs} (*)$	Forward Transconductance	$V_{DS} = 25\text{ V}$ $I_D = 5\text{ A}$	2.7	4.5		S
$C_{iss}$ $C_{oss}$ $C_{rss}$	Input Capacitance Output Capacitance Reverse Transfer Capacitance	$V_{DS} = 25\text{ V}$ $f = 1\text{ MHz}$ $V_{GS} = 0$		330 90 25	450 120 40	pF pF pF

SWITCHING

Symbol	Parameter	Test Conditions	Min.	Typ.	Max.	Unit
$t_{d(on)}$ $t_r$	Turn-on Time Rise Time	$V_{DD} = 50\text{ V}$ $I_D = 5.5\text{ A}$ $R_{GS} = 4.7\ \Omega$ $V_{GS} = 10\text{ V}$		10 50	15 75	ns ns
$t_{d(off)}$ $t_f$	Turn-off Delay Time Fall Time			25 20	40 30	ns ns

**ELECTRICAL CHARACTERISTICS** (continued)  
SOURCE DRAIN DIODE

Symbol	Parameter	Test Conditions	Min.	Typ.	Max.	Unit
$I_{SD}$	Source-drain Current				11	A
$I_{SDM}$	Source-drain Current (pulsed)				44	A
$V_{SD} (*)$	Forward On Voltage	$I_{SD} = 22\text{ A}$ $V_{GS} = 0$			1.6	V
$t_{rr}$	Reverse Recovery Time	$I_{SD} = 11\text{ A}$ $V_{DD} = 20\text{ V}$ $di/dt = 100\text{ A}/\mu\text{s}$ $T_j = 150\text{ }^\circ\text{C}$		80		ns
$Q_{rr}$	Reverse Recovery Charge			0.22		$\mu\text{C}$

(\*) Pulsed: Pulse duration = 300  $\mu\text{s}$ , duty cycle 1.5 %

Safe Operating Area

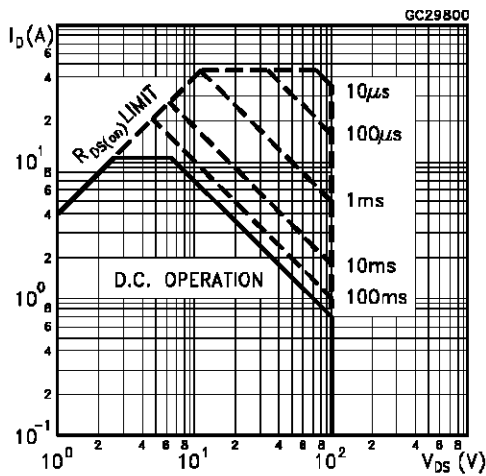

Thermal Impedance

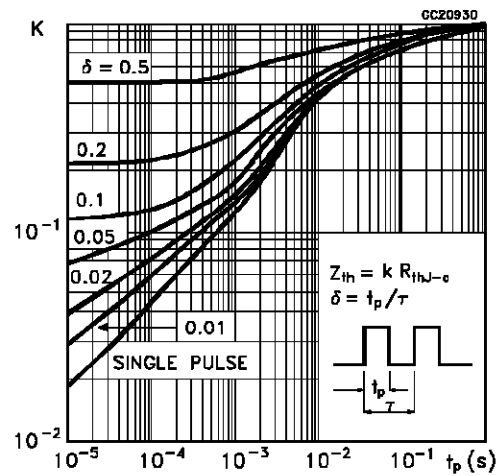

Derating Curve

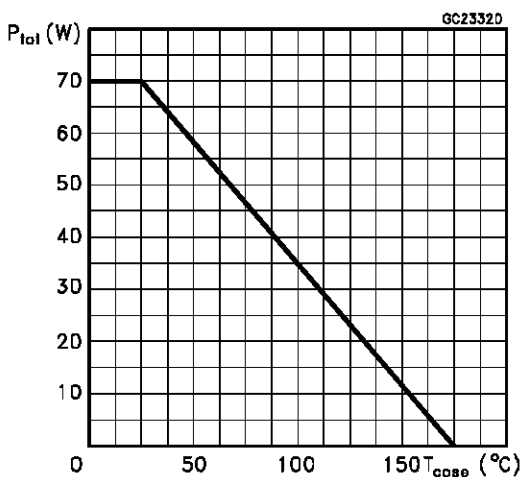

Output Characteristics

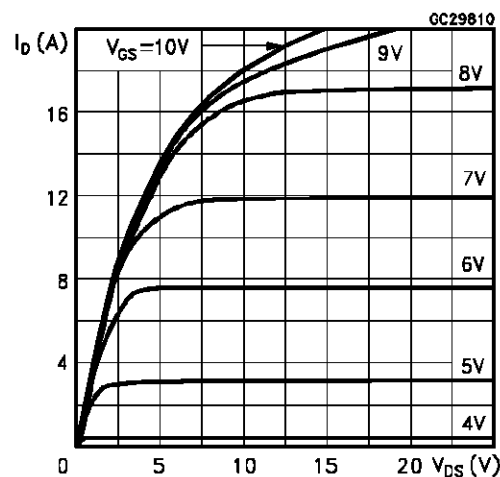

# BUZ72A

Transfer Characteristics

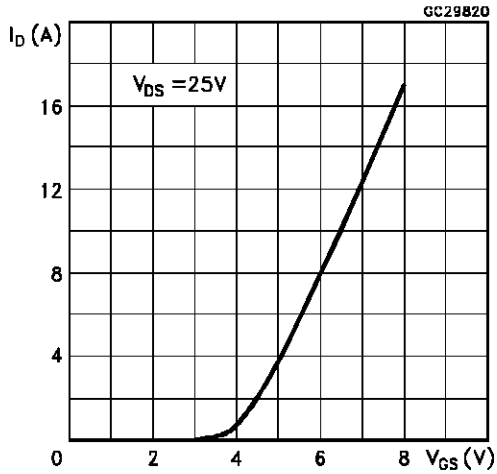

Transconductance

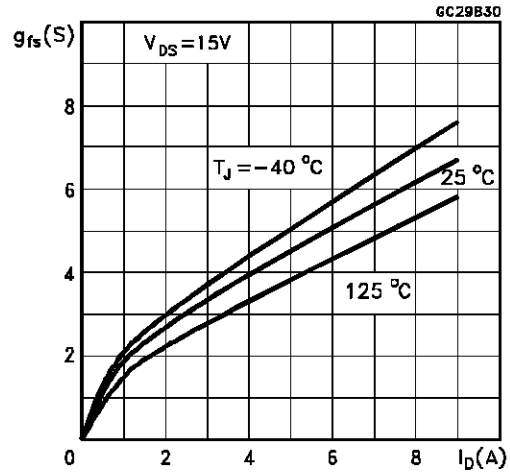

Static Drain-Source On Resistance

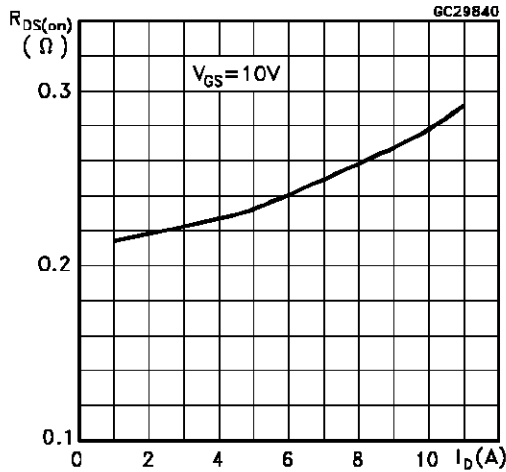

Maximum Drain Current vs Temperature

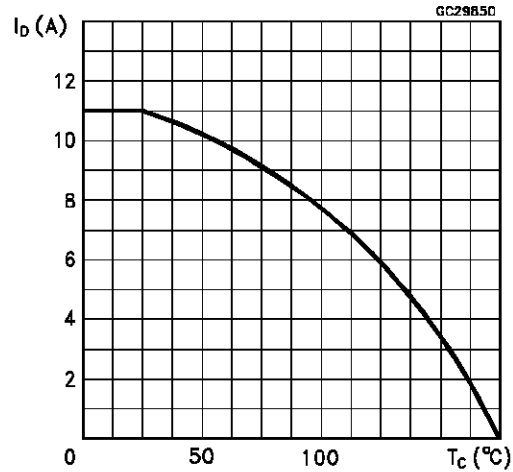

Gate Charge vs Gate-Source Voltage

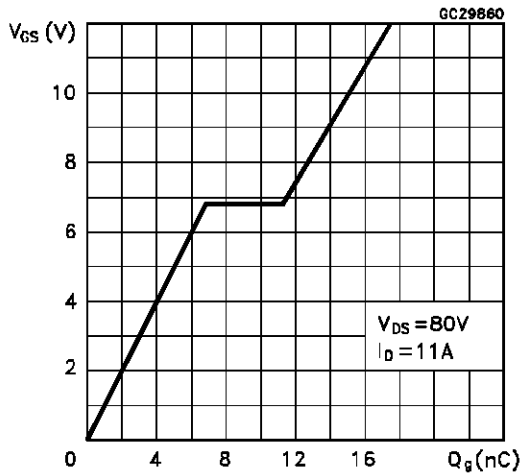

Capacitance Variation

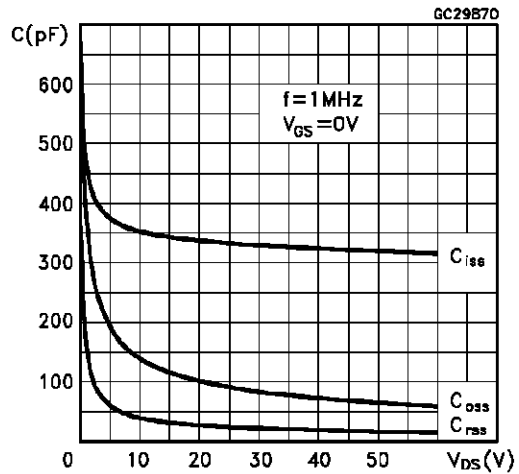

Normalized Gate Threshold Voltage vs Temperature

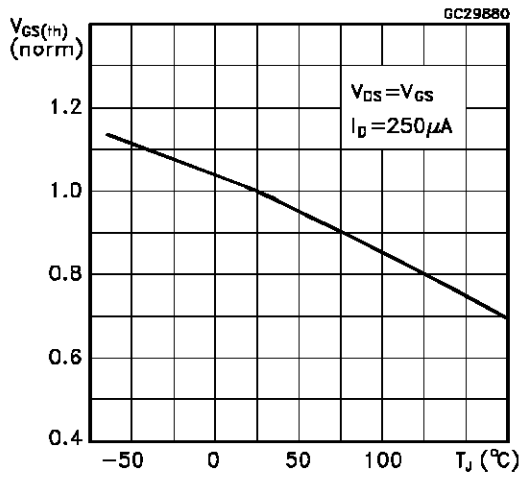

Normalized On Resistance vs Temperature

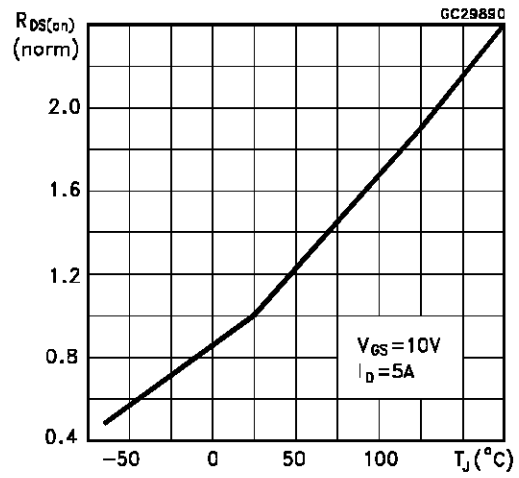

Source-Drain Diode Forward Characteristics

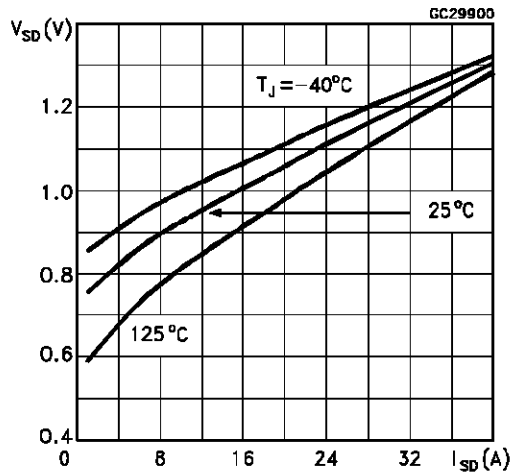

TO-220 MECHANICAL DATA

DIM.	mm			inch		
	MIN.	TYP.	MAX.	MIN.	TYP.	MAX.
A	4.40		4.60	0.173		0.181
C	1.23		1.32	0.048		0.051
D	2.40		2.72	0.094		0.107
D1		1.27			0.050	
E	0.49		0.70	0.019		0.027
F	0.61		0.88	0.024		0.034
F1	1.14		1.70	0.044		0.067
F2	1.14		1.70	0.044		0.067
G	4.95		5.15	0.194		0.203
G1	2.4		2.7	0.094		0.106
H2	10.0		10.40	0.393		0.409
L2		16.4			0.645	
L4	13.0		14.0	0.511		0.551
L5	2.65		2.95	0.104		0.116
L6	15.25		15.75	0.600		0.620
L7	6.2		6.6	0.244		0.260
L9	3.5		3.93	0.137		0.154
DIA.	3.75		3.85	0.147		0.151

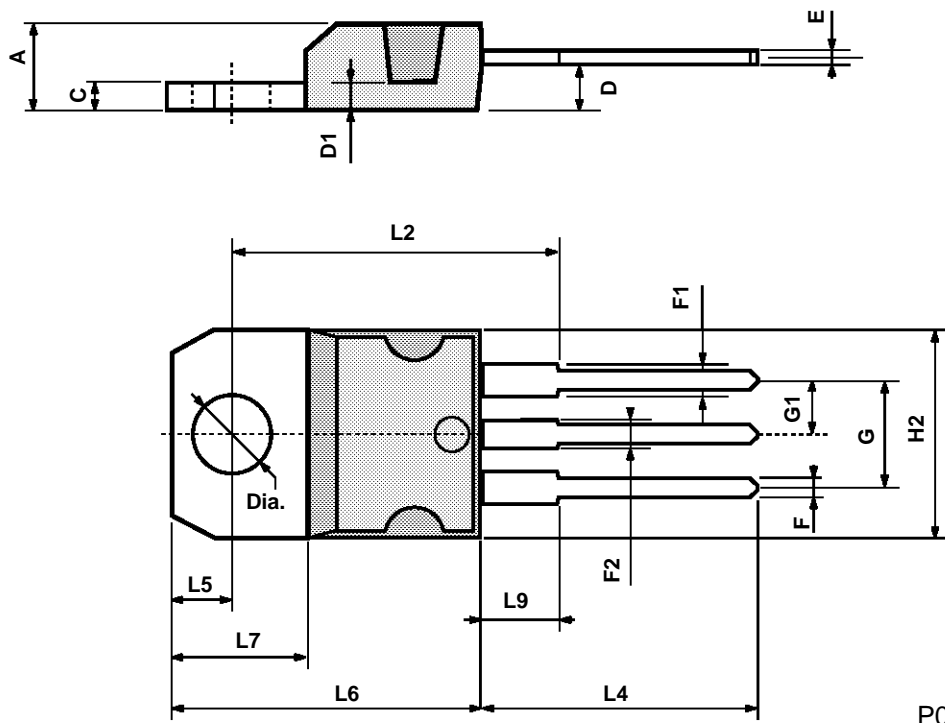

P011C

Information furnished is believed to be accurate and reliable. However, SGS-THOMSON Microelectronics assumes no responsibility for the consequences of use of such information nor for any infringement of patents or other rights of third parties which may result from its use. No license is granted by implication or otherwise under any patent or patent rights of SGS-THOMSON Microelectronics. Specifications mentioned in this publication are subject to change without notice. This publication supersedes and replaces all information previously supplied. SGS-THOMSON Microelectronics products are not authorized for use as critical components in life support devices or systems without express written approval of SGS-THOMSON Microelectronics.

© 1994 SGS-THOMSON Microelectronics - All Rights Reserved

SGS-THOMSON Microelectronics GROUP OF COMPANIES

Australia - Brazil - France - Germany - Hong Kong - Italy - Japan - Korea - Malaysia - Malta - Morocco - The Netherlands -  
Singapore - Spain - Sweden - Switzerland - Taiwan - Thailand - United Kingdom - U.S.A

This datasheet has been download from:

[www.datasheetcatalog.com](http://www.datasheetcatalog.com)

Datasheets for electronics components.