



MOTOROLA
Semiconductors

2N5583

The RF Line

PNP SILICON HIGH-FREQUENCY TRANSISTOR

... designed for applications in high frequency amplifiers and non-saturated switching circuits. High gain-bandwidth product characteristic provides excellent performance in a variety of small signal and linear amplifier applications.

- High Current-Gain-Bandwidth Product —
 $f_T = 1300$ (Min) @ $I_C = 100$ mAdc
- Low Collector-Base Time Constant —
 $r_b' C_C = 8.0$ ps (Typ) @ $I_C = 50$ mAdc

1.3 GHz @ 100 mAdc
**HIGH-FREQUENCY
TRANSISTOR**
PNP SILICON

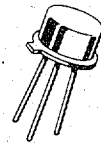

MAXIMUM RATINGS

Rating	Symbol	Value	Unit
* Collector-Emitter Voltage	V_{CE0}	30	Vdc
* Collector-Base Voltage	V_{CB}	30	Vdc
* Emitter-Base Voltage	V_{EB}	3.0	Vdc
* Collector Current — Continuous	I_C	500	mAdc
Total Device Dissipation @ $T_A = 25^\circ\text{C}$ Derate above 25°C	P_D	1.0 5.71	Watt mW/ $^\circ\text{C}$
* Total Device Dissipation @ $T_C = 25^\circ\text{C}$ Derate above 25°C	P_D	5.0 28.6	Watts mW/ $^\circ\text{C}$
* Operating and Storage Junction Temperature Range	T_J, T_{stg}	-65 to +200	$^\circ\text{C}$

* Indicates JEDEC Registered Data.

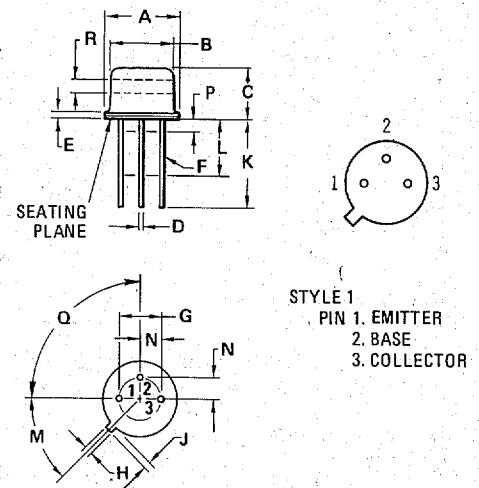

DIM	MILLIMETERS		INCHES	
	MIN	MAX	MIN	MAX
A	8.89	9.40	0.350	0.370
B	8.00	8.51	0.315	0.335
C	6.10	6.60	0.240	0.260
D	0.406	0.533	0.016	0.021
E	0.229	3.18	0.009	0.125
F	0.406	0.483	0.016	0.019
G	4.83	5.33	0.190	0.210
H	0.711	0.864	0.028	0.034
J	0.737	1.02	0.029	0.040
K	12.70	—	0.500	—
L	6.35	—	0.250	—
M	45° NOM		45° NOM	
P	—	1.27	—	0.050
Q	90° NOM		90° NOM	
R	2.54	—	0.100	—

All JEDEC dimensions and notes apply.

CASE 79-02
TO-39

ELECTRICAL CHARACTERISTICS ($T_A = 25^\circ\text{C}$ unless otherwise noted)

Characteristic	Figure No.	Symbol	Min	Typ	Max	Unit
----------------	------------	--------	-----	-----	-----	------

***OFF CHARACTERISTICS**

Collector-Emitter Breakdown Voltage (Note 1) ($I_C = 10 \text{ mA}$, $I_B = 0$)	—	BV_{CEO}	30	—	—	Vdc
Collector-Base Breakdown Voltage ($I_C = 10 \mu\text{A}$, $I_E = 0$)	—	BV_{CBO}	30	—	—	Vdc
Emitter-Base Breakdown Voltage ($I_E = 100 \mu\text{A}$, $I_C = 0$)	—	BV_{EBO}	3.0	—	—	Vdc
Collector Cutoff Current ($V_{CB} = 20 \text{ Vdc}$, $I_E = 0$)	4	I_{CBO}	—	—	50	nAdc
Emitter Cutoff Current ($V_{EB} = 2.0 \text{ Vdc}$, $I_C = 0$)	—	I_{EBO}	—	—	0.5	μAdc

***ON CHARACTERISTICS**

DC Current Gain (Note 1) ($I_C = 40 \text{ mA}$, $V_{CE} = 2.0 \text{ Vdc}$) ($I_C = 100 \text{ mA}$, $V_{CE} = 2.0 \text{ Vdc}$) ($I_C = 300 \text{ mA}$, $V_{CE} = 5.0 \text{ Vdc}$)	1	h_{FE}	20 25 15	40 40 22	— 100 —	—
Collector-Emitter Saturation Voltage (Note 1) ($I_C = 100 \text{ mA}$, $I_B = 10 \text{ mA}$)	2,3	$V_{CE(sat)}$	—	0.6	0.8	Vdc
Base-Emitter On Voltage (Note 1) ($I_C = 100 \text{ mA}$, $V_{CE} = 2.0 \text{ Vdc}$)	3	$V_{BE(on)}$	—	0.84	1.8	Vdc

SMALL-SIGNAL CHARACTERISTICS

*Current-Gain-Bandwidth Product ($I_C = 40 \text{ mA}$, $V_{CE} = 10 \text{ Vdc}$, $f = 100 \text{ MHz}$) ($I_C = 100 \text{ mA}$, $V_{CE} = 10 \text{ Vdc}$, $f = 100 \text{ MHz}$)	7	f_T	1000 1300	1300 1500	— —	MHz
*Collector-Base Capacitance ($V_{CB} = 15 \text{ Vdc}$, $I_E = 0$, $f = 100 \text{ kHz}$)	5	C_{cb}	—	2.5	5.0	pF
*Emitter-Base Capacitance ($V_{EB} = 0.5 \text{ Vdc}$, $I_C = 0$, $f = 100 \text{ kHz}$)	5	C_{eb}	—	18	35	pF
Collector-Base Time Constant ($I_C = 50 \text{ mA}$, $V_{CB} = 10 \text{ Vdc}$, $f = 63.6 \text{ MHz}$)	8	$r_b' C_c$	—	8.0	—	ps

SWITCHING CHARACTERISTICS

Delay Time ($V_{CC} = 31.4 \text{ Vdc}$, $I_C = 150 \text{ mA}$, $R_C = 160 \text{ Ohms}$, $R_E = 26.6 \text{ Ohms}$)	9,10	t_d	—	1.0	—	ns
Rise Time	9,10	t_r	—	2.1	—	ns
Fall Time	9,10	t_f	—	1.8	—	ns

*Indicates JEDEC Registered Data.

Note 1: Pulse Test: Pulse Width $\leq 300 \mu\text{s}$, Duty Cycle = 2.0%.

FIGURE 1 - DC CURRENT GAIN

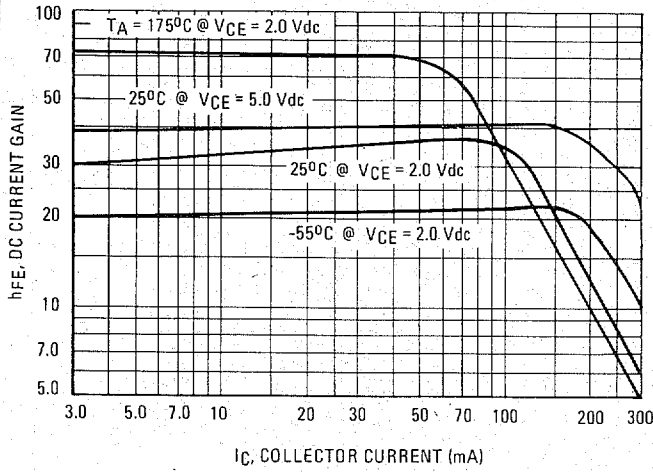

FIGURE 2 - COLLECTOR SATURATION REGION

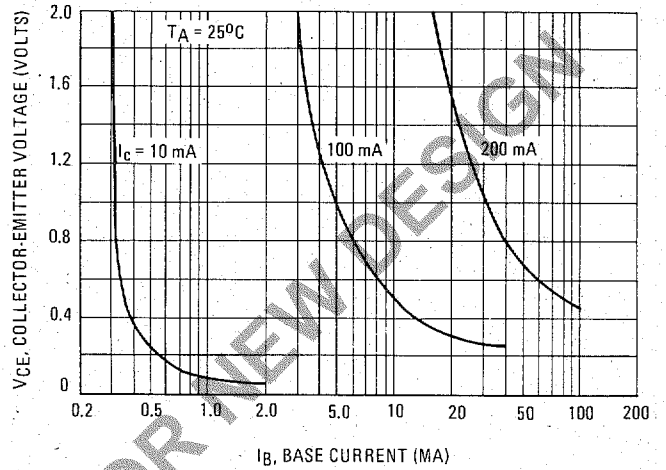

FIGURE 3 - "ON" VOLTAGES

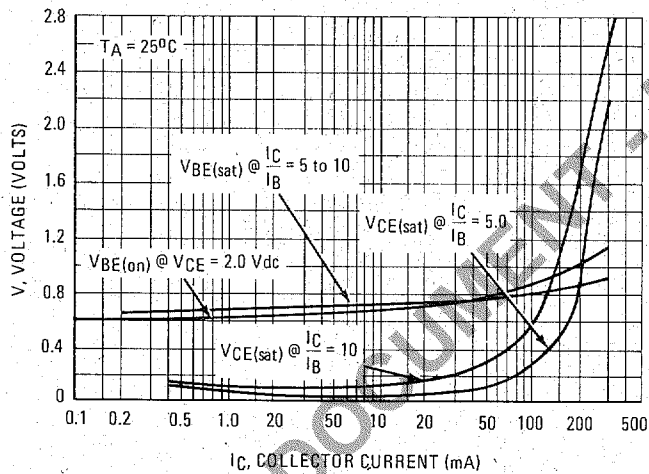

FIGURE 4 - COLLECTOR CURRENT versus BASE VOLTAGE

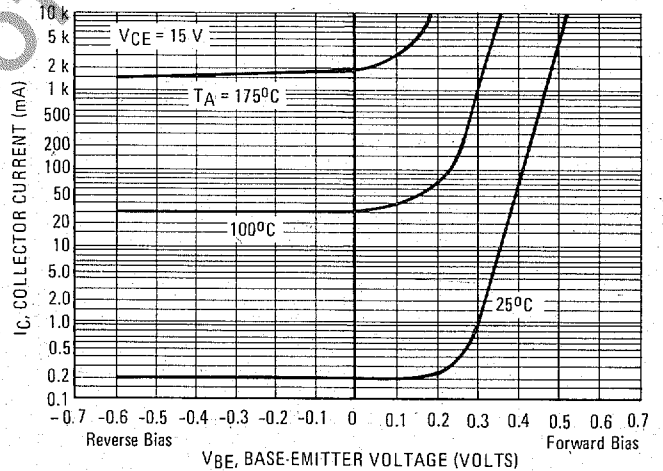

FIGURE 5 - CAPACITANCES

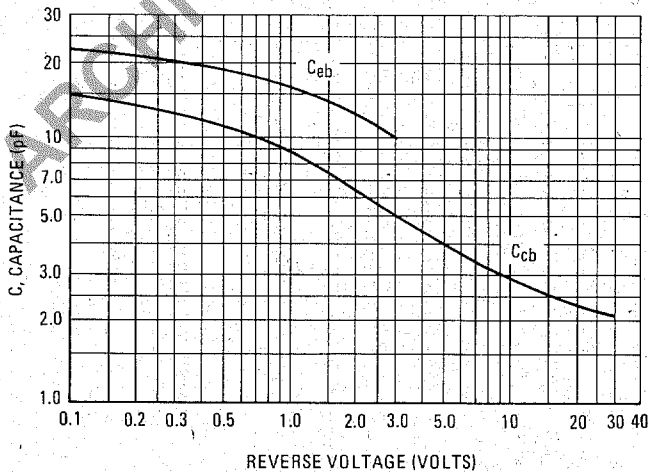

FIGURE 6 - TEMPERATURE COEFFICIENTS

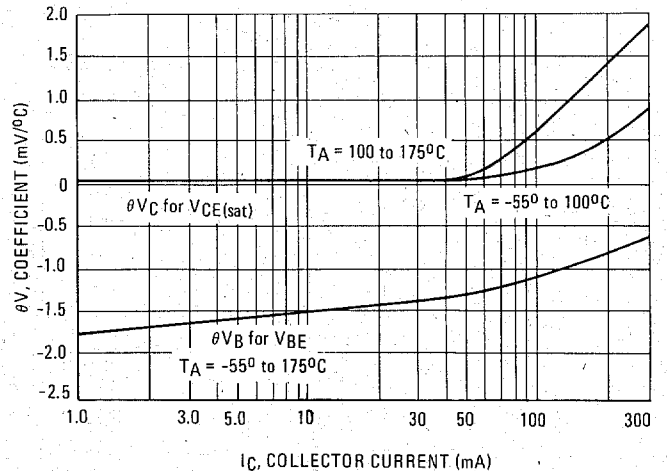

FIGURE 7 – CURRENT-GAIN-BANDWIDTH PRODUCT

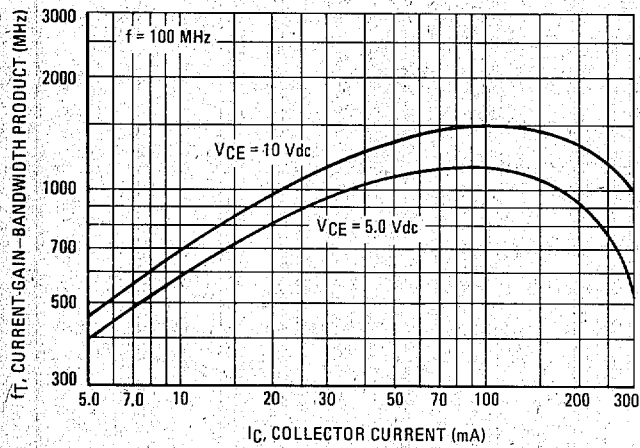

FIGURE 8 – COLLECTOR-BASE TIME CONSTANT

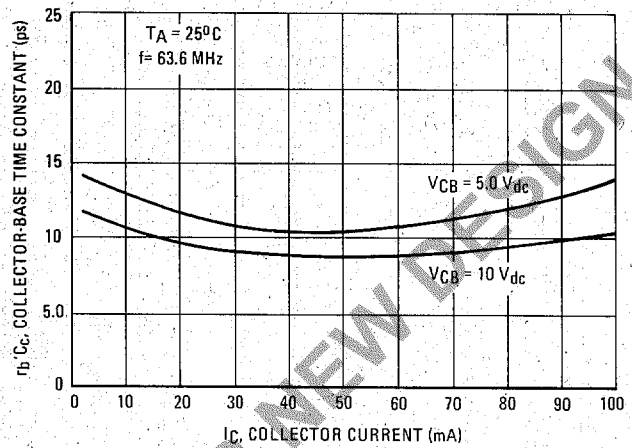

FIGURE 9 – SWITCHING TIMES

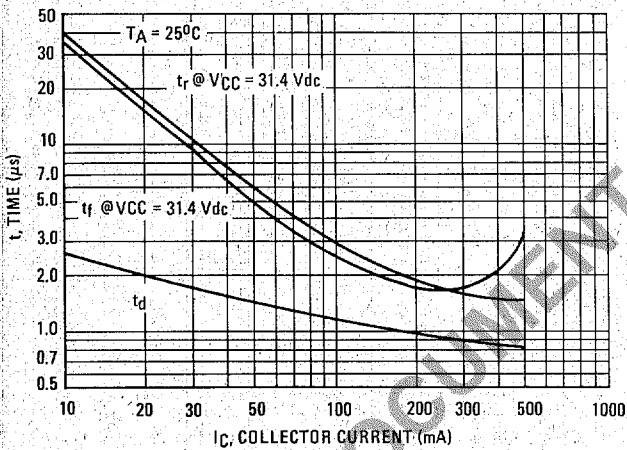
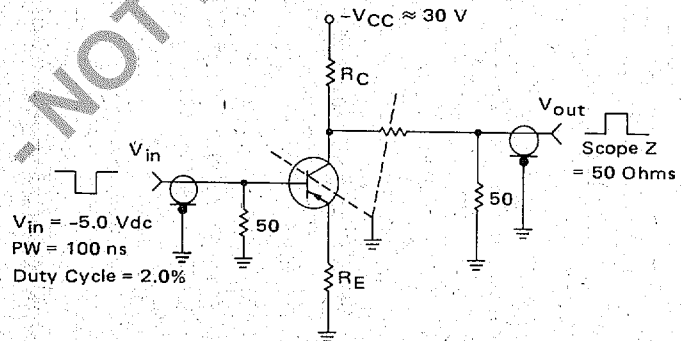

FIGURE 10 – SWITCHING TIMES TEST CIRCUIT



I_C mA	R_C Ohms	R_E Ohms	V_{CC} Volts
50	526	80	34.4
150	160	26.6	31.4
300	78	13.3	30.6
500	46.5	8.0	30.3

