

NEGATIVE FIXED VOLTAGE REGULATOR

DESCRIPTION

The SG7900A/SG7900 series of negative regulators offer self-contained, fixed-voltage capability with up to 1.5A of load current. With a variety of output voltages and four package options this regulator series is an optimum complement to the SG7800A/SG7800, SG140 line of three terminal regulators.

These units feature a unique band gap reference which allows the SG7900A series to be specified with an output voltage tolerance of $\pm 1.5\%$. The SG7900A versions also offer much improved line regulation characteristics.

All protective features of thermal shutdown, current limiting, and safe-area control have been designed into these units and since these regulators require only a single output capacitor (SG7900 series) or a capacitor and 5mA minimum load (SG120 series) for satisfactory performance, ease of application is assured.

Although designed as fixed-voltage regulators, the output voltage can be increased through the use of a simple voltage divider. The low quiescent drain current of the device insures good regulation when this method is used, especially for the SG120 series.

These devices are available in hermetically sealed TO-257, TO-3, TO-39 and LCC package.

FEATURES

- Output voltage set internally to $\pm 1.5\%$ on SG7900A
- Output current to 1.5A
- Excellent line and load regulation
- Foldback current limiting
- Thermal overload protection
- Voltages available: -5V, -12V, -15V
- Contact factory for other voltage options
- Available in surface mount package

HIGH RELIABILITY FEATURES - SG7900A/SG7900

- ◆ Available to MIL-STD - 883
- ◆ MIL-M38510/11501BXA - JAN7905T
- ◆ MIL-M38510/11505BYA - JAN7905K
- ◆ MIL-M38510/11502BXA - JAN7912T
- ◆ MIL-M38510/11506BYA - JAN7912K
- ◆ MIL-M38510/11503BXA - JAN7915T
- ◆ MIL-M38510/11507BYA - JAN7915K
- ◆ LMI level "S" processing available

SCHEMATIC DIAGRAM

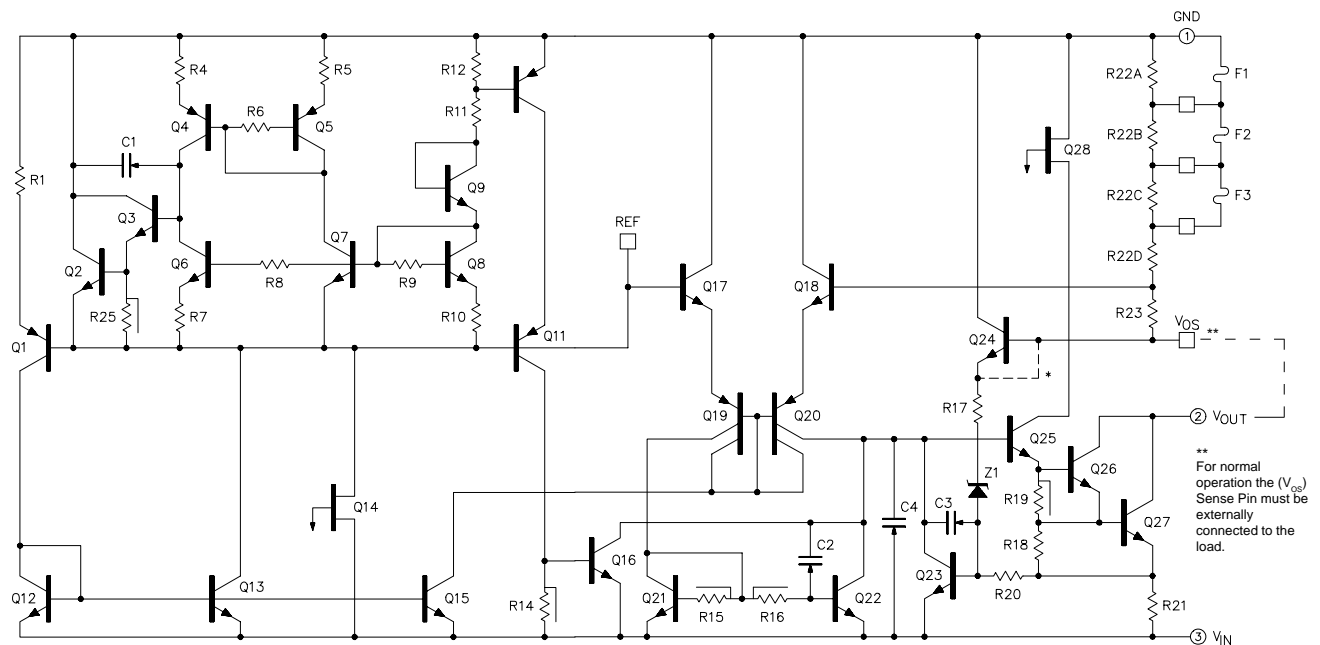

* WIRE EXISTS IF 120 TYPE DEVICE.
WIRE DOES NOT EXIST IF 7900 TYPE DEVICE.
SELECTABLE BY EMITTER OPTION.

** For normal operation the (V_{OS}) Sense Pin must be externally connected to the load.

ABSOLUTE MAXIMUM RATINGS (Note 1)

Device Output Voltage	Input Voltage	Input Voltage Differential (Output shorted to ground)
-5V	-35V	35V
-12V	-35V	35V
-15V	-40V	35V

Operating Junction Temperature 150°C
 Hermetic (K, T, IG & L - Packages) 150°C
 Storage Temperature Range -65°C to 150°C
 Lead Temperature (Soldering, 10 Seconds) 300°C

Note 1. Values beyond which damage may occur.

THERMAL DATA

K Package:

Thermal Resistance-Junction to Case, θ_{JC} 3.0°C/W
 Thermal Resistance-Junction to Ambient, θ_{JA} 35°C/W

T Package:

Thermal Resistance-Junction to Case, θ_{JC} 15°C/W
 Thermal Resistance-Junction to Ambient, θ_{JA} 120°C/W

IG Package:

Thermal Resistance-Junction to Case, θ_{JC} 3.5°C/W
 Thermal Resistance-Junction to Ambient, θ_{JA} 42°C/W

L Package:

Thermal Resistance-Junction to Case, θ_{JC} 35°C/W
 Thermal Resistance-Junction to Ambient, θ_{JA} 120°C/W

Note A. Junction Temperature Calculation: $T_J = T_A + (P_D \times \theta_{JA})$.

Note B. The above numbers for θ_{JC} are maximums for the limiting thermal resistance of the package in a standard mounting configuration. The θ_{JA} numbers are meant to be guidelines for the thermal performance of the device/pc-board system. All of the above assume no ambient airflow.

RECOMMENDED OPERATING CONDITIONS (Note 2)

Operating Junction Temperature Range:
 SG7900A/7900 -55°C to 150°C

Note 2. Range over which the device is functional.

CHARACTERISTIC CURVES

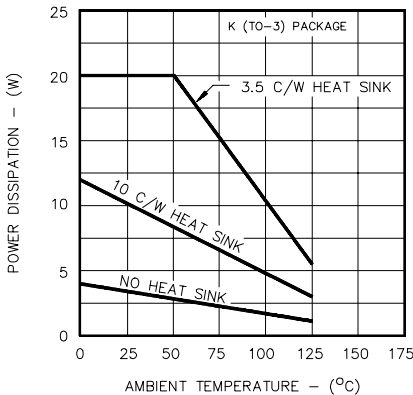

FIGURE 1. MAXIMUM AVERAGE POWER DISSIPATION

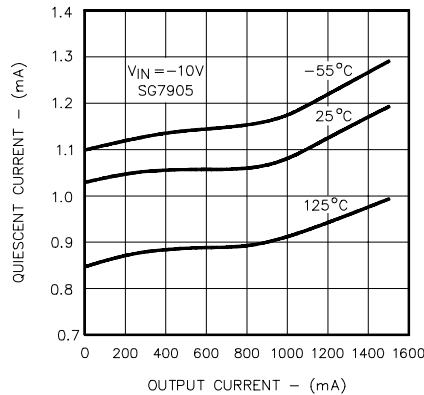

FIGURE 2. QUIESCENT CURRENT VS. LOAD

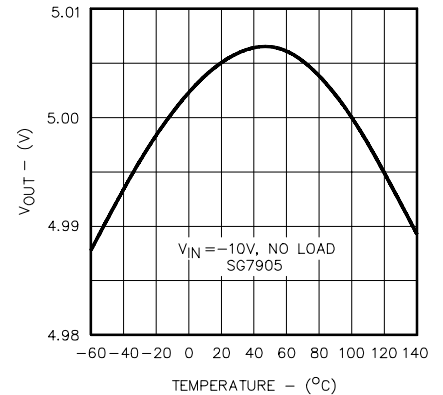

FIGURE 3. TEMPERATURE COEFFICIENT

CHARACTERISTIC CURVES (continued)

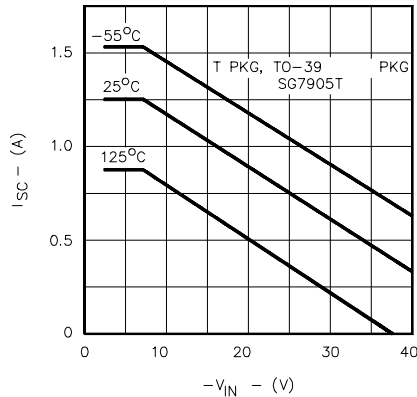

FIGURE 4. SHORTCIRCUIT CURRENT VS. V_{IN}

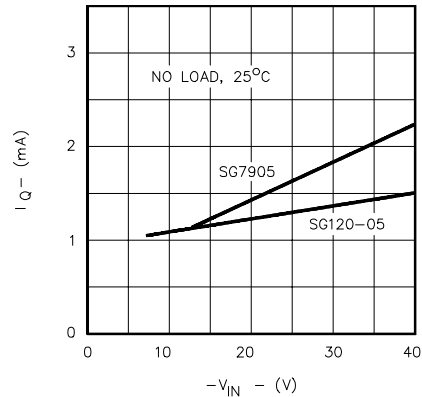

FIGURE 5. QUIESCENT CURRENT VS. V_{IN}

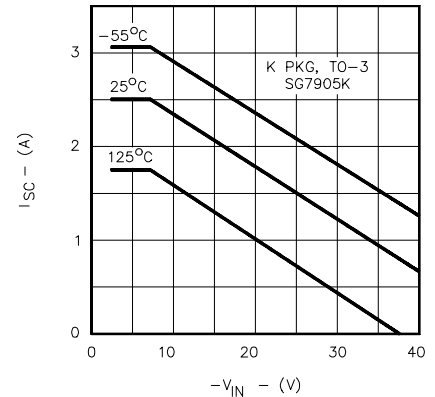

FIGURE 6. SHORT CIRCUIT CURRENT VS. V_{IN}

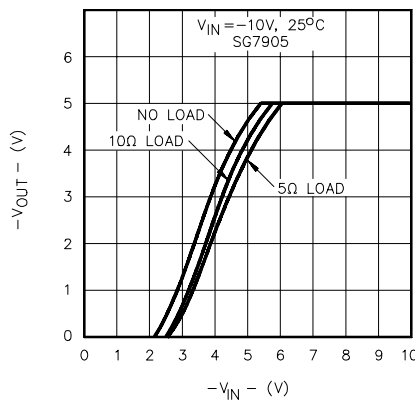

FIGURE 7. DROPOUT CHARACTERISTICS

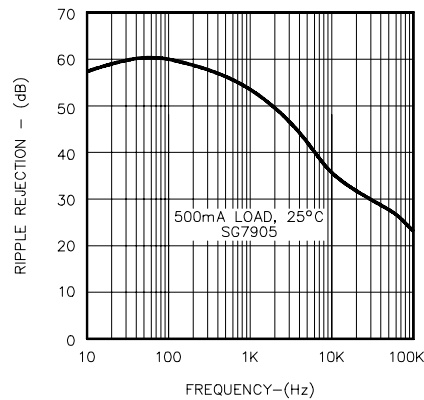

FIGURE 8. RIPPLE REJECTION VS. FREQUENCY

APPLICATIONS

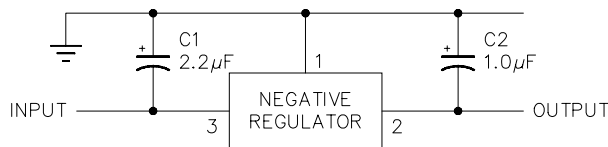

FIGURE 9 - FIXED OUTPUT REGULATOR

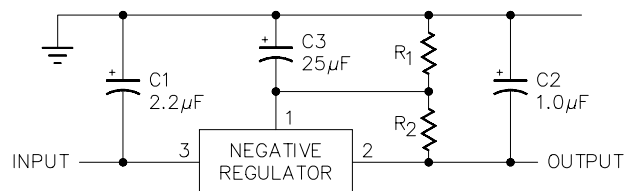

FIGURE 10 - CIRCUIT FOR INCREASING OUTPUT VOLTAGE

- NOTE: 1. C1 is required only if regulator is separated from rectifier filter.
 2. Both C1 and C2 should be low E.S.R. types such as solid tantalum. If aluminum electrolytics are used, at least 10 times values shown should be selected.
 3. If large output capacities are used, the regulators must be protected from momentary input shorts. A high current diode

NOTE: C3 optional for improved transient response and ripple rejection

$$V_{OUT} = V(\text{REGULATOR}) \frac{R_1 + R_2}{R_1} \quad R_2 = \frac{V(\text{REG})}{15\text{mA}}$$

ELECTRICAL SPECIFICATIONS (Note 1)

(Unless otherwise specified, these specifications apply over the operating ambient temperatures for SG7905A/SG7905 with $-55^{\circ}\text{C} \leq T_A \leq 150^{\circ}\text{C}$, $V_{IN} = -10\text{V}$, $I_O = 500\text{mA}$ for the K and IG -Power Packages-, $I_O = 100\text{mA}$ for the T and L packages, $C_{IN} = 2\mu\text{F}$, and $C_{OUT} = 1.0\mu\text{F}$. Low duty cycle pulse testing techniques are used which maintains junction and case temperatures equal to the ambient temperature.)

SG7905A/SG7905

Parameter	Test Conditions	SG7905A			SG7905			Units
		Min.	Typ.	Max.	Min.	Typ.	Max.	
Output Voltage	$T_J = 25^{\circ}\text{C}$	-4.92	-5.00	-5.08	-4.8	-5.0	-5.2	V
Line Regulation (Note 1)	$V_{IN} = -7.5\text{V to } -25\text{V}$, $T_J = 25^{\circ}\text{C}$		5	25		3	50	mV
	$V_{IN} = -8\text{V to } -12\text{V}$, $T_J = 25^{\circ}\text{C}$		3	12		1	25	mV
Load Regulation (Note 1)	Power Pkgs: $I_O = 5\text{mA to } 1.5\text{A}$, $T_J = 25^{\circ}\text{C}$		15	75		15	100	mV
	$I_O = 250\text{mA to } 750\text{mA}$, $T_J = 25^{\circ}\text{C}$		15	25		15	25	mV
	T - Pkg: $I_O = 5\text{mA to } 500\text{mA}$, $T_J = 25^{\circ}\text{C}$		5	30		5	100	mV
Total Output Voltage Tolerance	$V_{IN} = -8\text{V to } -20\text{V}$ Power Pkgs: $I_O = 5\text{mA to } 1.0\text{A}$, $P \leq 20\text{W}$ T - Pkg: $I_O = 5\text{mA to } 500\text{mA}$, $P \leq 2\text{W}$	-4.85	-5.00	-5.15	-4.70	-5.00	-5.30	V
Quiescent Current	Over Temperature Range $T_J = 25^{\circ}\text{C}$			2.5			2.5	mA
				2.0			2.0	mA
Quiescent Current Change	with Line: $V_{IN} = -8\text{V to } -25\text{V}$ with Load: $I_O = 5\text{mA to } 1.0\text{A}$ (Power Packages) $I_O = 5\text{mA to } 500\text{mA}$ (T)			1.3			1.3	mA
				0.5			0.5	mA
Dropout Voltage	$\Delta V_O = 100\text{mV}$, $T_J = 25^{\circ}\text{C}$ Power Pkgs: $I_O = 1.0\text{A}$, T - Pkg: $I_O = 500\text{mA}$		1.1	2.3		1.1	2.3	V
Peak Output Current	Power Pkgs: $T_J = 25^{\circ}\text{C}$ T - Pkg: $T_J = 25^{\circ}\text{C}$	1.5		3.3	1.5		3.3	A
		0.5		1.4	0.5		1.4	A
Short Circuit Current	Power Pkgs: $V_{IN} = -35\text{V}$, $T_J = 25^{\circ}\text{C}$ T - Pkg: $V_{IN} = -35\text{V}$, $T_J = 25^{\circ}\text{C}$			1.2			1.2	A
				0.6			0.6	A
Ripple Rejection	$\Delta V_{IN} = 10\text{V}$, $f = 120\text{Hz}$, $T_J = 25^{\circ}\text{C}$	54			54			dB
Output Noise Voltage (rms)	$f = 10\text{Hz to } 100\text{KHz}$ (Note 2)		25	80		25	80	$\mu\text{V/V}$
Long Term Stability	1000hrs. at $T_J = 125^{\circ}\text{C}$		20			20		mV
Thermal Shutdown	$I_O = 5\text{mA}$		175			175		$^{\circ}\text{C}$

Note 1. All regulation tests are made at constant junction temperature with low duty cycle testing.
2. This test is guaranteed but is not tested in production.

ELECTRICAL SPECIFICATIONS (Note 1)

(Unless otherwise specified, these specifications apply over the operating ambient temperatures for SG7912A/SG7912 with $-55^{\circ}\text{C} \leq T_A \leq 150^{\circ}\text{C}$, $V_{IN} = -19\text{V}$, $I_O = 500\text{mA}$ for the K and IG -Power Packages-, $I_O = 100\text{mA}$ for the T and L packages, $C_{IN} = 2\mu\text{F}$, and $C_{OUT} = 1.0\mu\text{F}$. Low duty cycle pulse testing techniques are used which maintains junction and case temperatures equal to the ambient temperature.)

SG7912A/SG7912

Parameter	Test Conditions	SG7912A			SG7912			Units
		Min.	Typ.	Max.	Min.	Typ.	Max.	
Output Voltage	$T_J = 25^{\circ}\text{C}$	-11.8	-12.0	-12.2	-11.5	-12.0	-12.5	V
Line Regulation (Note 1)	$V_{IN} = -14.5\text{V to } -30\text{V}$, $T_J = 25^{\circ}\text{C}$		4	60		10	120	mV
	$V_{IN} = -16\text{V to } -22\text{V}$, $T_J = 25^{\circ}\text{C}$		3	30		3	60	mV
Load Regulation (Note 1)	Power Pkgs: $I_O = 5\text{mA to } 1.5\text{A}$, $T_J = 25^{\circ}\text{C}$		20	90		12	120	mV
	$I_O = 250\text{mA to } 750\text{mA}$, $T_J = 25^{\circ}\text{C}$		10	40		4	60	mV
	T - Pkg: $I_O = 5\text{mA to } 500\text{mA}$, $T_J = 25^{\circ}\text{C}$		10	40		10	240	mV
Total Output Voltage Tolerance	$V_{IN} = -14.5\text{V to } -27\text{V}$ Power Pkgs: $I_O = 5\text{mA to } 1.0\text{A}$, $P \leq 20\text{W}$ T - Pkg: $I_O = 5\text{mA to } 500\text{mA}$, $P \leq 2\text{W}$	-11.7	-12.0	-12.3	-11.4	-12.0	-12.6	V
Quiescent Current	Over Temperature Range $T_J = 25^{\circ}\text{C}$			4			4	mA
				3			3	mA
Quiescent Current Change	with Line: $V_{IN} = -14.5\text{V to } -30\text{V}$ with Load: $I_O = 5\text{mA to } 1.0\text{A}$ (Power Packages) $I_O = 5\text{mA to } 500\text{mA}$ (T)			1.0			1.0	mA
				0.5			0.5	mA
Dropout Voltage	$\Delta V_O = 100\text{mV}$, $T_J = 25^{\circ}\text{C}$ Power Pkgs: $I_O = 1.0\text{A}$, T - Pkg: $I_O = 500\text{mA}$		1.1	2.3		1.1	2.3	V
Peak Output Current	Power Pkgs: $T_J = 25^{\circ}\text{C}$ T - Pkg: $T_J = 25^{\circ}\text{C}$	1.5		3.3	1.5		3.3	A
		0.5		1.4	0.5		1.4	A
Short Circuit Current	Power Pkgs: $V_{IN} = -35\text{V}$, $T_J = 25^{\circ}\text{C}$ T - Pkg: $V_{IN} = -35\text{V}$, $T_J = 25^{\circ}\text{C}$			1.2			0.2	A
				0.6			0.6	A
Ripple Rejection	$\Delta V_{IN} = 10\text{V}$, $f = 120\text{Hz}$, $T_J = 25^{\circ}\text{C}$	54			54			dB
Output Noise Voltage (rms)	$f = 10\text{Hz to } 100\text{KHz}$ (Note 2)		25	80		25	80	$\mu\text{V/V}$
Long Term Stability	1000hrs. at $T_J = 125^{\circ}\text{C}$		60			60		mV
Thermal Shutdown	$I_O = 5\text{mA}$		175			175		$^{\circ}\text{C}$

Note 1. All regulation tests are made at constant junction temperature with low duty cycle testing.
2. This test is guaranteed but is not tested in production.

ELECTRICAL SPECIFICATIONS (Note 1)

(Unless otherwise specified, these specifications apply over the operating ambient temperatures for SG7915A/SG7915 with $-55^{\circ}\text{C} \leq T_A \leq 150^{\circ}\text{C}$, $V_{IN} = -23\text{V}$, $I_O = 500\text{mA}$ for the K and IG -Power Packages-, $I_O = 100\text{mA}$ for the T and L packages, $C_{IN} = 2\mu\text{F}$, and $C_{OUT} = 1.0\mu\text{F}$. Low duty cycle pulse testing techniques are used which maintains junction and case temperatures equal to the ambient temperature.)

SG7915A/SG7915

Parameter	Test Conditions	SG7915A			SG7915			Units
		Min.	Typ.	Max.	Min.	Typ.	Max.	
Output Voltage	$T_J = 25^{\circ}\text{C}$	-14.8	-15.0	-15.2	-14.4	-15.0	-15.6	V
Line Regulation (Note 1)	$V_{IN} = -17.5\text{V to } -30\text{V}$, $T_J = 25^{\circ}\text{C}$		5	75		11	150	mV
	$V_{IN} = -20\text{V to } -25\text{V}$, $T_J = 25^{\circ}\text{C}$		3	40		3	75	mV
Load Regulation (Note 1)	Power Pkgs: $I_O = 5\text{mA to } 1.5\text{A}$, $T_J = 25^{\circ}\text{C}$		30	100		12	150	mV
	$I_O = 250\text{mA to } 750\text{mA}$, $T_J = 25^{\circ}\text{C}$		4	50		4	75	mV
	T - Pkg: $I_O = 5\text{mA to } 500\text{mA}$, $T_J = 25^{\circ}\text{C}$		10	50		10	240	mV
Total Output Voltage Tolerance	$V_{IN} = -18.5\text{V to } -30\text{V}$ Power Pkgs: $I_O = 5\text{mA to } 1.0\text{A}$, $P \leq 20\text{W}$ T - Pkg: $I_O = 5\text{mA to } 500\text{mA}$, $P \leq 2\text{W}$	-14.6	-15.0	-15.4	-14.25	-15.00	-15.75	V
Quiescent Current	Over Temperature Range $T_J = 25^{\circ}\text{C}$			4			4	mA
Quiescent Current Change	with Line: $V_{IN} = -18.5\text{V to } -30\text{V}$ with Load: $I_O = 5\text{mA to } 1.0\text{A}$ (Power Packages) $I_O = 5\text{mA to } 500\text{mA}$ (T)			1.0			1.0	mA
				0.5			0.5	mA
Dropout Voltage	$\Delta V_O = 100\text{mV}$, $T_J = 25^{\circ}\text{C}$ Power Pkgs: $I_O = 1.0\text{A}$, T - Pkg: $I_O = 500\text{mA}$		1.1	2.3		1.1	2.3	V
Peak Output Current	Power Pkgs: $T_J = 25^{\circ}\text{C}$ T - Pkg: $T_J = 25^{\circ}\text{C}$	1.5		3.3	1.5		3.3	A
		0.5		1.4	0.5		1.4	A
Short Circuit Current	Power Pkgs: $V_{IN} = -35\text{V}$, $T_J = 25^{\circ}\text{C}$ T - Pkg: $V_{IN} = -35\text{V}$, $T_J = 25^{\circ}\text{C}$			1.2			1.2	A
				0.6			0.6	A
Ripple Rejection	$\Delta V_{IN} = 10\text{V}$, $f = 120\text{Hz}$, $T_J = 25^{\circ}\text{C}$	54			54			dB
Output Noise Voltage (rms)	$f = 10\text{Hz to } 100\text{KHz}$ (Note 2)		25	80		25	80	$\mu\text{V/V}$
Long Term Stability	1000hrs. at $T_J = 125^{\circ}\text{C}$		60			60		mV
Thermal Shutdown	$I_O = 5\text{mA}$		175			175		$^{\circ}\text{C}$

Note 1. All regulation tests are made at constant junction temperature with low duty cycle testing.
2. This test is guaranteed but is not tested in production.

CONNECTION DIAGRAMS & ORDERING INFORMATION (See Notes Below)

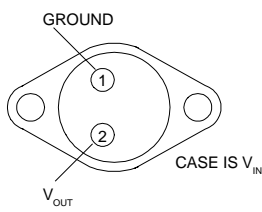
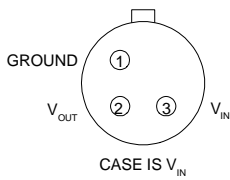
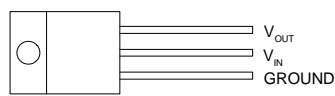
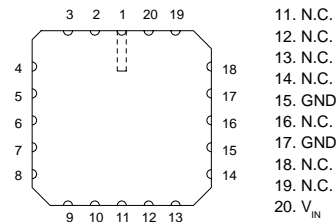
Package	Part No.	Ambient Temperature Range	Connection Diagram
3-TERMINAL TO-3 METAL CAN K-PACKAGE	SG79XXAK/883B SG7905AK/DESC SG7912AK/DESC SG7915AK/DESC SG79XXAK SG79XXK/883B JAN7905K JAN7912K JAN7915K SG79XXK SG79XXK	-55°C to 125°C -55°C to 125°C -55°C to 125°C -55°C to 125°C -55°C to 125°C -55°C to 125°C -55°C to 125°C -55°C to 125°C -55°C to 125°C -55°C to 125°C 0°C to 125°C	
3-PIN TO-39 METAL CAN T-PACKAGE	SG79XXAT/883B SG7905AT/DESC SG7912AT/DESC SG7915AT/DESC SG79XXAT SG79XXT/883B JAN7905T JAN7912T JAN7915T SG79XXT	-55°C to 125°C -55°C to 125°C -55°C to 125°C -55°C to 125°C -55°C to 125°C -55°C to 125°C -55°C to 125°C -55°C to 125°C -55°C to 125°C -55°C to 125°C	
3-PIN HERMETIC TO-257 IG-PACKAGE (Isolated)	SG79XXAIG/883B SG7905AIG/DESC SG7912AIG/DESC SG7915AIG/DESC SG79XXAIG SG79XXIG/883B SG79XXIG	-55°C to 125°C -55°C to 125°C -55°C to 125°C -55°C to 125°C -55°C to 125°C -55°C to 125°C -55°C to 125°C	
20-PIN CERAMIC LEADLESS CHIP CARRIER L- PACKAGE	SG79XXL/883B SG79XXL SG7905AL/DESC SG7912AL/DESC SG7915AL/DESC	-55°C to 125°C -55°C to 125°C -55°C to 125°C -55°C to 125°C -55°C to 125°C	(See Notes 5 & 6) 

- Note 1. Contact factory for JAN and DESC product availability.
 2. All parts are viewed from the top.
 3. "XX" to be replaced by output voltage of specific fixed regulator.
 4. Some products will be available in hermetic flat pack (F). Consult factory for price and availability.
 5. Both inputs and outputs must be externally connected together at the device terminals.
 6. For normal operation, the V_O SENSE pin must be externally connected to the load.