



OCTAL BUS TRANSCEIVER

The SN54/74LS245 is an Octal Bus Transmitter/Receiver designed for 8-line asynchronous 2-way data communication between data buses. Direction Input (DR) controls transmission of Data from bus A to bus B or bus B to bus A depending upon its logic level. The Enable input (E) can be used to isolate the buses.

- Hysteresis Inputs to Improve Noise Immunity
- 2-Way Asynchronous Data Bus Communication
- Input Diodes Limit High-Speed Termination Effects
- ESD > 3500 Volts

LOGIC AND CONNECTION DIAGRAMS DIP (TOP VIEW)

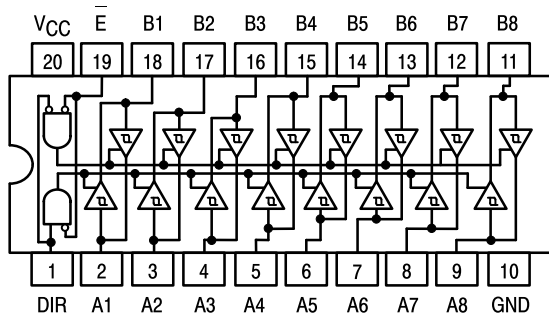

TRUTH TABLE

INPUTS		OUTPUT
E	DIR	
L	L	Bus B Data to Bus A
L	H	Bus A Data to Bus B
H	X	Isolation

H = HIGH Voltage Level
 L = LOW Voltage Level
 X = Immaterial

SN54/74LS245

OCTAL BUS TRANSCEIVER LOW POWER SCHOTTKY

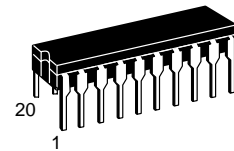

J SUFFIX
 CERAMIC
 CASE 732-03

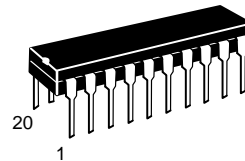

N SUFFIX
 PLASTIC
 CASE 738-03

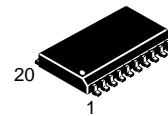

DW SUFFIX
 SOIC
 CASE 751D-03

ORDERING INFORMATION

SN54LSXXXJ Ceramic
 SN74LSXXXN Plastic
 SN74LSXXXDW SOIC

GUARANTEED OPERATING RANGES

Symbol	Parameter		Min	Typ	Max	Unit
V _{CC}	Supply Voltage	54	4.5	5.0	5.5	V
		74	4.75	5.0	5.25	
T _A	Operating Ambient Temperature Range	54	-55	25	125	°C
		74	0	25	70	
I _{OH}	Output Current — High	54, 74			-3.0	mA
		54 74			-12 -15	mA
I _{OL}	Output Current — Low	54			12	mA
		74			24	

SN54/74LS245

DC CHARACTERISTICS OVER OPERATING TEMPERATURE RANGE (unless otherwise specified)

Symbol	Parameter		Limits			Unit	Test Conditions
			Min	Typ	Max		
V _{IH}	Input HIGH Voltage		2.0			V	Guaranteed Input HIGH Voltage for All Inputs
V _{IL}	Input LOW Voltage	54			0.7	V	Guaranteed Input LOW Voltage for All Inputs
		74			0.8		
V _{T+} -V _{T-}	Hysteresis		0.2	0.4		V	V _{CC} = MIN
V _{IK}	Input Clamp Diode Voltage			-0.65	-1.5	V	V _{CC} = MIN, I _{IN} = -18 mA
V _{OH}	Output HIGH Voltage	54, 74	2.4	3.4		V	V _{CC} = MIN, I _{OH} = -3.0 mA
		54, 74	2.0			V	V _{CC} = MIN, I _{OH} = MAX
V _{OL}	Output LOW Voltage	54, 74		0.25	0.4	V	I _{OL} = 12 mA
		74		0.35	0.5	V	I _{OL} = 24 mA
							V _{CC} = V _{CC} MIN, V _{IN} = V _{IL} or V _{IH} per Truth Table
I _{OZH}	Output Off Current HIGH				20	μA	V _{CC} = MAX, V _{OUT} = 2.7 V
I _{OZL}	Output Off Current LOW				-200	μA	V _{CC} = MAX, V _{OUT} = 0.4 V
I _{IH}	Input HIGH Current	A or B, DR or E			20	μA	V _{CC} = MAX, V _{IN} = 2.7 V
		DR or E			0.1	mA	V _{CC} = MAX, V _{IN} = 7.0 V
		A or B			0.1	mA	V _{CC} = MAX, V _{IN} = 5.5 V
I _{IL}	Input LOW Current				-0.2	mA	V _{CC} = MAX, V _{IN} = 0.4 V
I _{OS}	Output Short Circuit Current (Note 1)		-40		-225	mA	V _{CC} = MAX
I _{CC}	Power Supply Current Total, Output HIGH				70	mA	V _{CC} = MAX
	Total, Output LOW				90		
	Total at HIGH Z				95		

Note 1: Not more than one output should be shorted at a time, nor for more than 1 second.

AC CHARACTERISTICS (T_A = 25°C, V_{CC} = 5.0 V, T_{RISE}/T_{FALL} ≤ 6.0 ns)

Symbol	Parameter		Limits			Unit	Test Conditions
			Min	Typ	Max		
t _{PLH} t _{PHL}	Propagation Delay, Data to Output			8.0 8.0	12 12	ns	C _L = 45 pF, R _L = 667 Ω
t _{PZH}	Output Enable Time to HIGH Level			25	40		
t _{PZL}	Output Enable Time to LOW Level			27	40		
t _{PLZ}	Output Disable Time from LOW Level			15	25	ns	C _L = 5.0 pF, R _L = 667 Ω
t _{PHZ}	Output Disable Time from HIGH Level			15	25		

**Case 751D-03 DW Suffix
20-Pin Plastic
SO-20 (WIDE)**

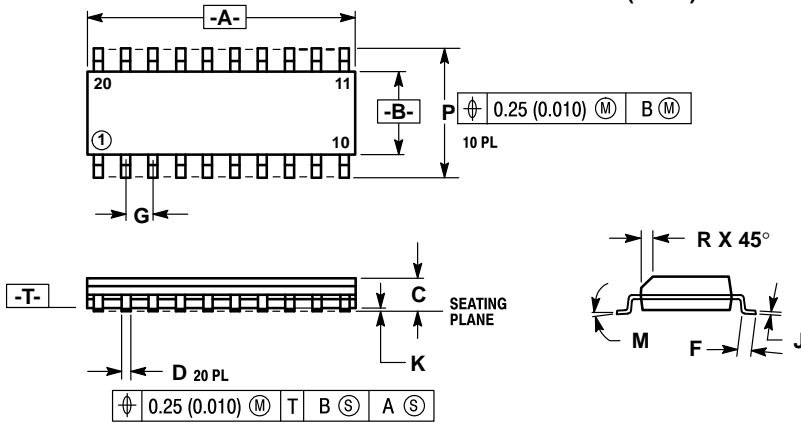

- NOTES:
1. DIMENSIONING AND TOLERANCING PER ANSI Y14.5M, 1982.
 2. CONTROLLING DIMENSION: MILLIMETER.
 3. DIMENSION A AND B DO NOT INCLUDE MOLD PROTRUSION.
 4. MAXIMUM MOLD PROTRUSION 0.15 (0.006) PER SIDE.
 5. 751D-01, AND -02 OBSOLETE, NEW STANDARD 751D-03.

DIM	MILLIMETERS		INCHES	
	MIN	MAX	MIN	MAX
A	12.65	12.95	0.499	0.510
B	7.40	7.60	0.292	0.299
C	2.35	2.65	0.093	0.104
D	0.35	0.49	0.014	0.019
F	0.50	0.90	0.020	0.035
G	1.27 BSC	0.050 BSC		
J	0.25	0.32	0.010	0.012
K	0.10	0.25	0.004	0.009
M	0°	7°	0°	7°
P	10.05	10.55	0.395	0.415
R	0.25	0.75	0.010	0.029

**Case 732-03 J Suffix
20-Pin Ceramic Dual In-Line**

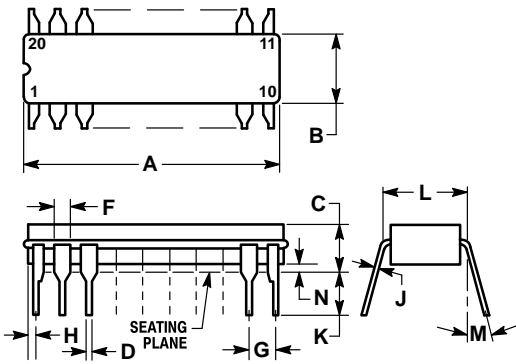

- NOTES:
1. LEADS WITHIN 0.25 mm (0.010) DIA., TRUE POSITION AT SEATING PLANE, AT MAXIMUM MATERIAL CONDITION.
 2. DIM L TO CENTER OF LEADS WHEN FORMED PARALLEL.
 3. DIM A AND B INCLUDES MENISCUS.

DIM	MILLIMETERS		INCHES	
	MIN	MAX	MIN	MAX
A	23.88	25.15	0.940	0.990
B	6.60	7.49	0.260	0.295
C	3.81	5.08	0.150	0.200
D	0.38	0.56	0.015	0.022
F	1.40	1.65	0.055	0.065
G	2.54 BSC	0.100 BSC		
H	0.51	1.27	0.020	0.050
J	0.20	0.30	0.008	0.012
K	3.18	4.06	0.125	0.160
L	7.62 BSC	0.300 BSC		
M	0°	15°	0°	15°
N	0.25	1.02	0.010	0.040

**Case 738-03 N Suffix
20-Pin Plastic**

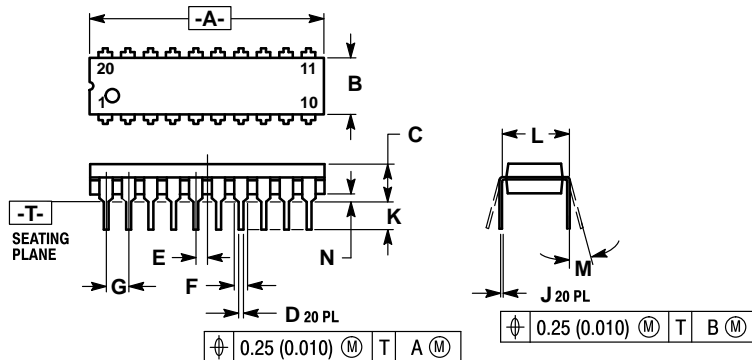

- NOTES:
1. DIMENSIONING AND TOLERANCING PER ANSI Y14.5M, 1982.
 2. CONTROLLING DIMENSION: INCH.
 3. DIMENSION "L" TO CENTER OF LEAD WHEN FORMED PARALLEL.
 4. DIMENSION "B" DOES NOT INCLUDE MOLD FLASH.
 5. 738-02 OBSOLETE, NEW STANDARD 738-03.

DIM	MILLIMETERS		INCHES	
	MIN	MAX	MIN	MAX
A	25.66	27.17	1.010	1.070
B	6.10	6.60	0.240	0.260
C	3.81	4.57	0.150	0.180
D	0.39	0.55	0.015	0.022
E	1.27 BSC	0.050 BSC		
F	1.27	1.77	0.050	0.070
G	2.54 BSC	0.100 BSC		
J	0.21	0.38	0.008	0.015
K	2.80	3.55	0.110	0.140
L	7.62 BSC	0.300 BSC		
M	0°	15°	0°	15°
N	0.51	1.01	0.020	0.040

Motorola reserves the right to make changes without further notice to any products herein. Motorola makes no warranty, representation or guarantee regarding the suitability of its products for any particular purpose, nor does Motorola assume any liability arising out of the application or use of any product or circuit, and specifically disclaims any and all liability, including without limitation consequential or incidental damages. "Typical" parameters can and do vary in different applications. All operating parameters, including "Typicals" must be validated for each customer application by customer's technical experts. Motorola does not convey any license under its patent rights nor the rights of others. Motorola products are not designed, intended, or authorized for use as components in systems intended for surgical implant into the body, or other applications intended to support or sustain life, or for any other application in which the failure of the Motorola product could create a situation where personal injury or death may occur. Should Buyer purchase or use Motorola products for any such unintended or unauthorized application, Buyer shall indemnify and hold Motorola and its officers, employees, subsidiaries, affiliates, and distributors harmless against all claims, costs, damages, and expenses, and reasonable attorney fees arising out of, directly or indirectly, any claim of personal injury or death associated with such unintended or unauthorized use, even if such claim alleges that Motorola was negligent regarding the design or manufacture of the part. Motorola and TM are registered trademarks of Motorola, Inc. Motorola, Inc. is an Equal Opportunity/Affirmative Action Employer.

Literature Distribution Centers:

USA: Motorola Literature Distribution; P.O. Box 20912; Phoenix, Arizona 85036.

EUROPE: Motorola Ltd.; European Literature Centre; 88 Tanners Drive, Blakelands, Milton Keynes, MK14 5BP, England.

JAPAN: Nippon Motorola Ltd.; 4-32-1, Nishi-Gotanda, Shinagawa-ku, Tokyo 141, Japan.

ASIA PACIFIC: Motorola Semiconductors H.K. Ltd.; Silicon Harbour Center, No. 2 Dai King Street, Tai Po Industrial Estate, Tai Po, N.T., Hong Kong.

SYMBOL	SW1	SW2
tpZH	Open	Closed
tpZL	Closed	Open
tpLZ	Closed	Closed

