

■ Features

- High speed switching
- Low on-resistance
- No secondary breakdown
- Low driving power
- High voltage
- $V_{GSS} = \pm 30V$ Guarantee
- Avalanche-proof

■ Applications

- Switching regulators
- UPS
- DC-DC converters
- General purpose power amplifier

■ Outline Drawings

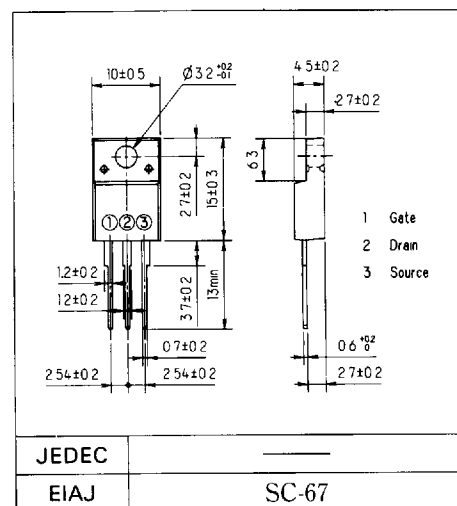

■ Max. Ratings and Characteristics

● Absolute Maximum Ratings ($T_c = 25^\circ C$):

Items	Symbols	Ratings	Units
Drain-source voltage	V_{DSS}	450	V
Continuous drain current	I_D	10	A
Pulsed drain current	$I_{D(puls)}$	35	A
Continuous reverse drain current	I_{DR}	10	A
Gate-source peak voltage	V_{GSS}	± 30	V
Max. power dissipation	P_D	50	W
Operating and storage temperature range	T_{ch}	150	$^\circ C$
	T_{stg}	$-55 \sim +150$	$^\circ C$

■ Equivalent Circuit Schematic

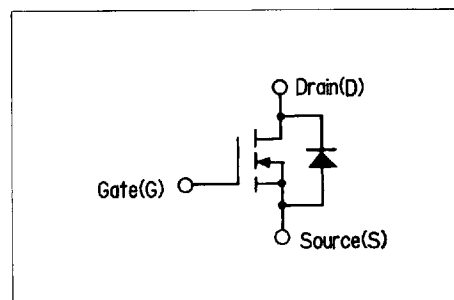

● Electrical Characteristics ($T_c = 25^\circ C$)

Items	Symbols	Test Conditions	Min.	Typ.	Max.	Units
Drain-source breakdown voltage	$V_{(BR)DSS}$	$I_D = 1mA$ $V_{GS} = 0V$	450			V
Gate threshold voltage	$V_{GS(th)}$	$I_D = 1mA$ $V_{DS} = V_{GS}$	2.5	3.5	5.0	V
Zero gate voltage drain current	I_{DSS}	$V_{DS} = 450V$		10	500	μA
		$V_{GS} = 0V$		0.2	1.0	mA
Gate-source leakage current	I_{GSS}	$V_{GS} = \pm 30V$ $V_{DS} = 0V$		10	100	nA
Drain-source on-state resistance	$R_{DS(on)}$	$I_D = 5A$ $V_{GS} = 10V$		0.5	0.65	Ω
Forward transconductance	g_{fs}	$I_D = 5A$ $V_{DS} = 25V$	4.0	6.5		S
Input capacitance	C_{iss}	$V_{DS} = 25V$		1200	1800	pF
Output capacitance	C_{oss}	$V_{GS} = 0V$		160	240	
Reverse transfer capacitance	C_{rss}	$f = 1MHz$		70	100	
Turn-on time t_{on} ($t_{on} + t_{d(on)} + t_r$)	$t_{d(on)}$	$V_{CC} = 300V$ $I_D = 10A$ $V_{GS} = 10V$ $R_G = 25\Omega$		30	45	ns
	t_r			80	120	
	$t_{d(off)}$			160	240	
Turn-off time t_{off} ($t_{d(off)} + t_f$)	t_f		80	120		
Diode forward on-voltage	V_{SD}	$I_F = 2 \times I_{DR}$ $V_{GS} = 0V$ $T_{ch} = 25^\circ C$		1.10	1.5	V
Reverse recovery time	t_{rr}	$I_F = I_{DR}$ $d_i/d_t = 100A/\mu s$ $T_{ch} = 25^\circ C$		500		ns

● Thermal Characteristics

Items	Symbols	Test Conditions	Min.	Typ.	Max.	Units
Thermal Resistance	$R_{th(ch-a)}$	channel to air			62.5	$^\circ C/W$
	$R_{th(ch-c)}$	channel to case			2.5	$^\circ C/W$

■ Characteristics

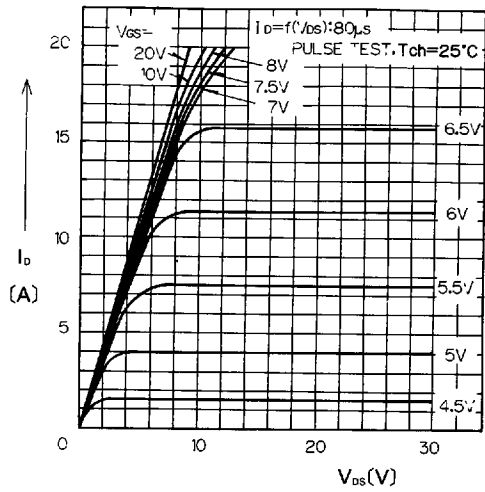

Typical Output Characteristics

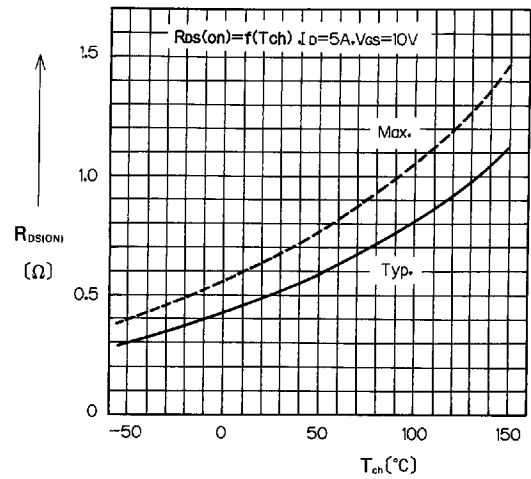

On State Resistance vs. T_{ch}

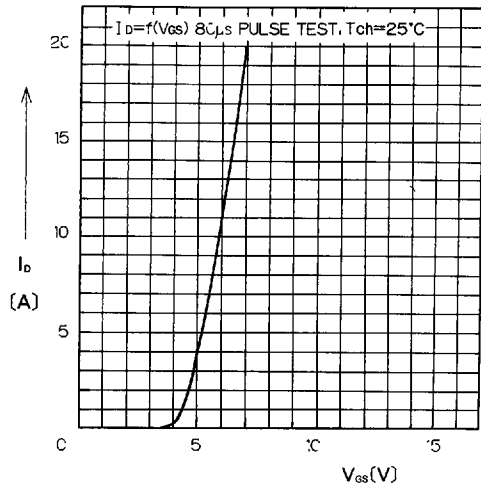

Typical Transfer Characteristics

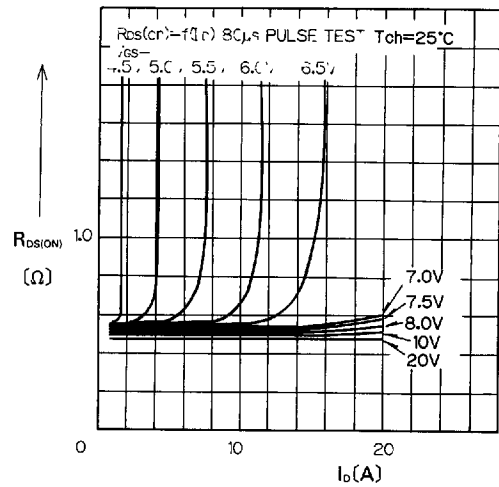

Typical Drain-Source on State Resistance vs. I_D

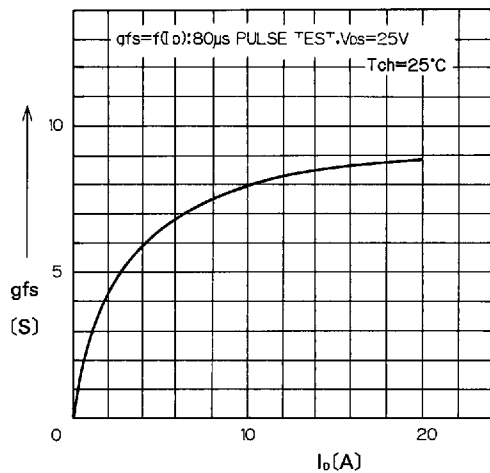

Typical Forward Transconductance vs. I_D

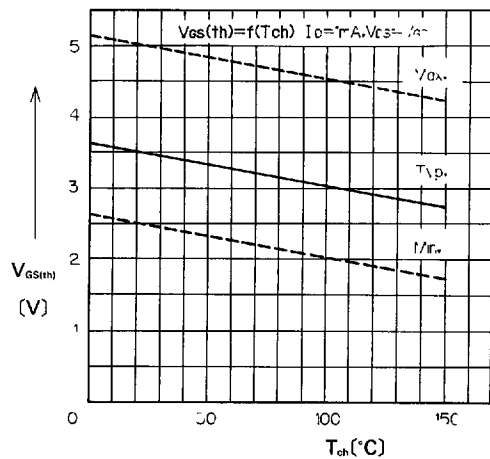

Gate Threshold Voltage vs. T_{ch}

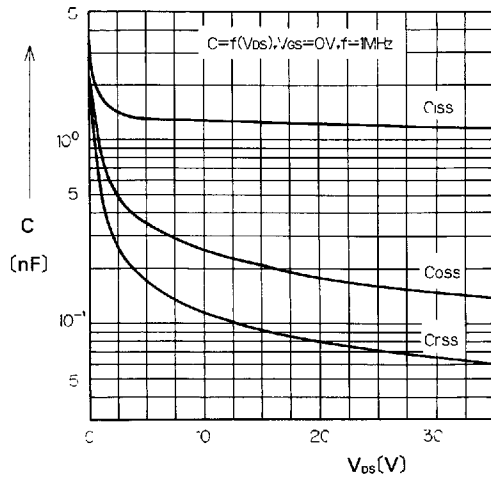

Typical Capacitance vs. V_{DS}

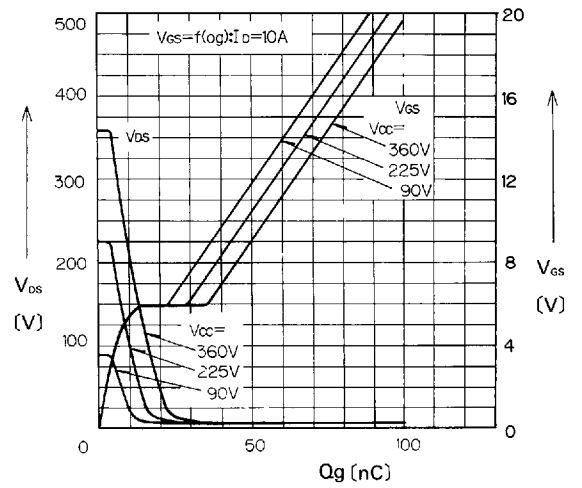

Typical Input Charge

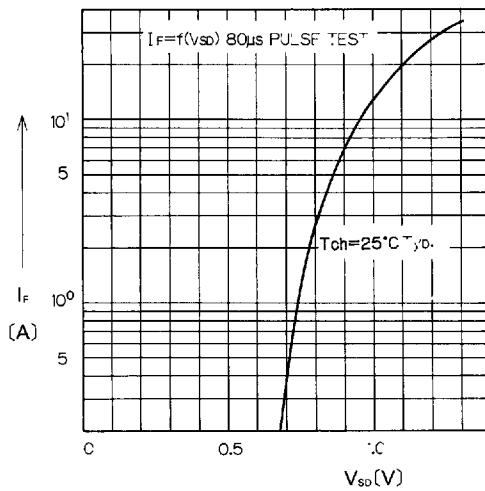

Forward Characteristics of Reverse Diode

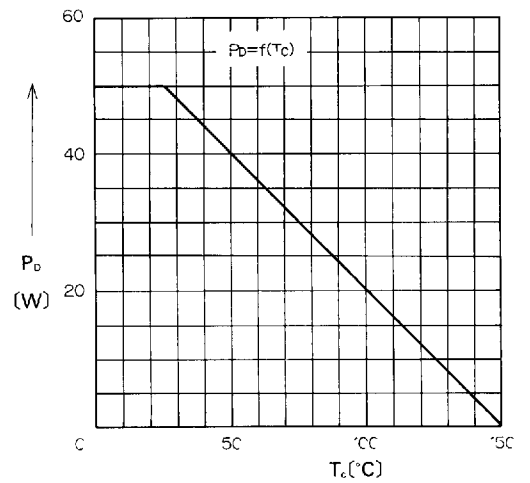

Allowable Power Dissipation vs. T_c

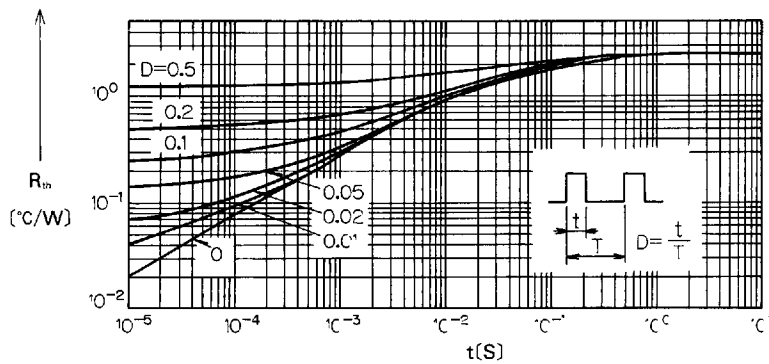

Transient Thermal Impedance

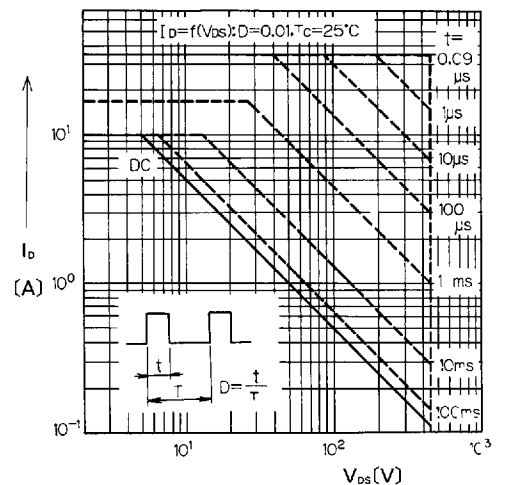

Safe Operating Area