

# Automotive Dual N-Channel 30 V (D-S) 175 °C MOSFET



PRODUCT SUMMARY	
$V_{DS}$ (V)	30
$R_{DS(on)}$ ( $\Omega$ ) at $V_{GS} = 10$ V	0.0123
$R_{DS(on)}$ ( $\Omega$ ) at $V_{GS} = 4.5$ V	0.0135
$I_D$ (A)	8
Configuration	Dual

## FEATURES

- TrenchFET® Power MOSFET
- AEC-Q101 Qualified
- 100 %  $R_g$  and UIS Tested
- Material categorization:  
For definitions of compliance please see [www.vishay.com/doc?99912](http://www.vishay.com/doc?99912)

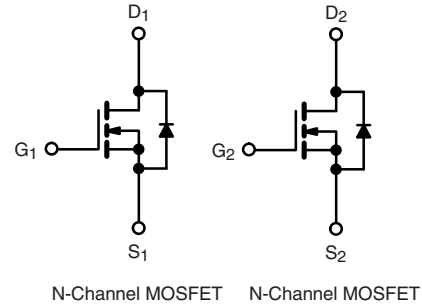
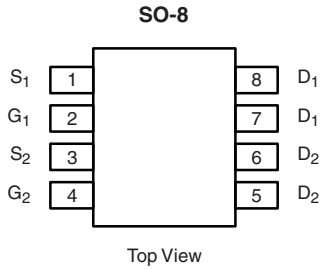

ORDERING INFORMATION	
Package	SO-8
Lead (Pb)-free and Halogen-free	SQ4282EY-T1-GE3

ABSOLUTE MAXIMUM RATINGS ( $T_C = 25$ °C, unless otherwise noted)				
PARAMETER	SYMBOL	LIMIT	UNIT	
Drain-Source Voltage	$V_{DS}$	30	V	
Gate-Source Voltage	$V_{GS}$	$\pm 20$		
Continuous Drain Current	$I_D$	$T_C = 25$ °C <sup>a</sup>	8	
		$T_C = 125$ °C	8	
Continuous Source Current (Diode Conduction)	$I_S$	3.5	A	
Pulsed Drain Current <sup>a</sup>	$I_{DM}$	32		
Single Pulse Avalanche Current	$I_{AS}$	34		
Single Pulse Avalanche Energy	$E_{AS}$	L = 0.1 mH	58	mJ
Maximum Power Dissipation <sup>a</sup>			$P_D$	
		$T_C = 125$ °C	1.3	
Operating Junction and Storage Temperature Range	$T_J, T_{stg}$	- 55 to + 175	°C	

THERMAL RESISTANCE RATINGS			
PARAMETER	SYMBOL	LIMIT	UNIT
Junction-to-Ambient	$R_{thJA}$	120	°C/W
Junction-to-Foot (Drain)			

## Notes

- Pulse test; pulse width  $\leq 300$   $\mu$ s, duty cycle  $\leq 2$  %.
- When mounted on 1" square PCB (FR-4 material).



SPECIFICATIONS ( $T_C = 25\text{ }^\circ\text{C}$ , unless otherwise noted)							
PARAMETER	SYMBOL	TEST CONDITIONS		MIN.	TYP.	MAX.	UNIT
<b>Static</b>							
Drain-Source Breakdown Voltage	$V_{DS}$	$V_{GS} = 0\text{ V}$ , $I_D = 250\text{ }\mu\text{A}$		30	-	-	V
Gate-Source Threshold Voltage	$V_{GS(th)}$	$V_{DS} = V_{GS}$ , $I_D = 250\text{ }\mu\text{A}$		1.5	2.0	2.5	
Gate-Source Leakage	$I_{GSS}$	$V_{DS} = 0\text{ V}$ , $V_{GS} = \pm 20\text{ V}$		-	-	$\pm 100$	nA
Zero Gate Voltage Drain Current	$I_{DSS}$	$V_{GS} = 0\text{ V}$	$V_{DS} = 30\text{ V}$	-	-	1	$\mu\text{A}$
		$V_{GS} = 0\text{ V}$	$V_{DS} = 30\text{ V}$ , $T_J = 125\text{ }^\circ\text{C}$	-	-	50	
		$V_{GS} = 0\text{ V}$	$V_{DS} = 30\text{ V}$ , $T_J = 175\text{ }^\circ\text{C}$	-	-	250	
On-State Drain Current <sup>a</sup>	$I_{D(on)}$	$V_{GS} = 10\text{ V}$	$V_{DS} \geq 5\text{ V}$	30	-	-	A
Drain-Source On-State Resistance <sup>a</sup>	$R_{DS(on)}$	$V_{GS} = 10\text{ V}$	$I_D = 15\text{ A}$	-	0.0100	0.0123	$\Omega$
		$V_{GS} = 10\text{ V}$	$I_D = 15\text{ A}$ , $T_J = 125\text{ }^\circ\text{C}$	-	-	0.0176	
		$V_{GS} = 10\text{ V}$	$I_D = 15\text{ A}$ , $T_J = 175\text{ }^\circ\text{C}$	-	-	0.0210	
		$V_{GS} = 4.5\text{ V}$	$I_D = 14\text{ A}$	-	0.0110	0.0135	
Forward Transconductance <sup>b</sup>	$g_{fs}$	$V_{DS} = 15\text{ V}$ , $I_D = 15\text{ A}$		-	67	-	S
<b>Dynamic<sup>b</sup></b>							
Input Capacitance	$C_{iss}$	$V_{GS} = 0\text{ V}$	$V_{DS} = 15\text{ V}$ , $f = 1\text{ MHz}$	-	1893	2367	$\text{pF}$
Output Capacitance	$C_{oss}$			-	396	495	
Reverse Transfer Capacitance	$C_{rss}$			-	139	173	
Total Gate Charge <sup>c</sup>	$Q_g$	$V_{GS} = 10\text{ V}$	$V_{DS} = 20\text{ V}$ , $I_D = 11\text{ A}$	-	31.5	47	nC
Gate-Source Charge <sup>c</sup>	$Q_{gs}$			-	6.4	-	
Gate-Drain Charge <sup>c</sup>	$Q_{gd}$			-	4	-	
Gate Resistance	$R_g$	f = 1 MHz		2.45	4.91	7.5	$\Omega$
Turn-On Delay Time <sup>c</sup>	$t_{d(on)}$	$V_{DD} = 15\text{ V}$ , $R_L = 1.67\text{ }\Omega$ $I_D = 9\text{ A}$ , $V_{GEN} = 10\text{ V}$ , $R_g = 1\text{ }\Omega$		-	10	15	ns
Rise Time <sup>c</sup>	$t_r$			-	11	17	
Turn-Off Delay Time <sup>c</sup>	$t_{d(off)}$			-	34	51	
Fall Time <sup>c</sup>	$t_f$			-	8	12	
<b>Source-Drain Diode Ratings and Characteristics<sup>b</sup></b>							
Pulsed Current <sup>a</sup>	$I_{SM}$			-	-	32	A
Forward Voltage	$V_{SD}$	$I_F = 8\text{ A}$ , $V_{GS} = 0\text{ V}$		-	0.76	1.2	V

**Notes**

- a. Pulse test; pulse width  $\leq 300\text{ }\mu\text{s}$ , duty cycle  $\leq 2\%$ .  
b. Guaranteed by design, not subject to production testing.  
c. Independent of operating temperature.

Stresses beyond those listed under "Absolute Maximum Ratings" may cause permanent damage to the device. These are stress ratings only, and functional operation of the device at these or any other conditions beyond those indicated in the operational sections of the specifications is not implied. Exposure to absolute maximum rating conditions for extended periods may affect device reliability.



TYPICAL CHARACTERISTICS (T<sub>A</sub> = 25 °C, unless otherwise noted)

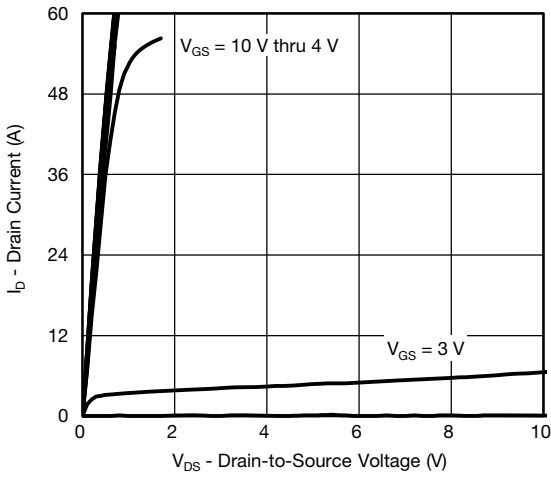

Output Characteristics

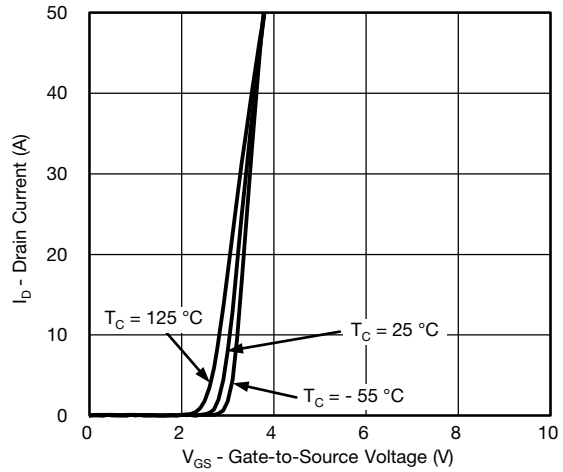

Transfer Characteristics

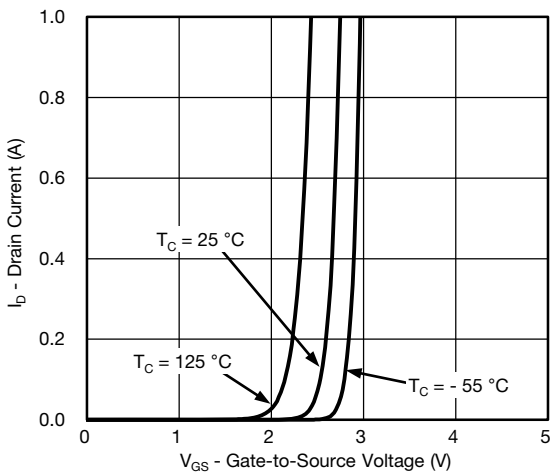

Transfer Characteristics

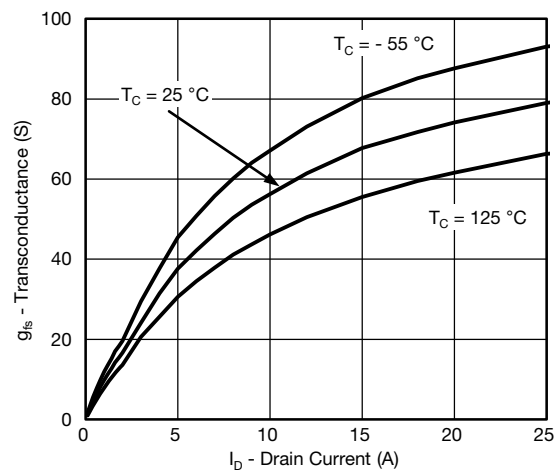

Transconductance

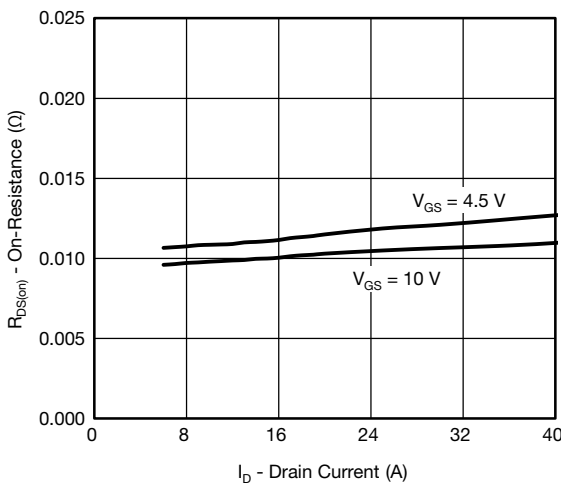

On-Resistance vs. Drain Current

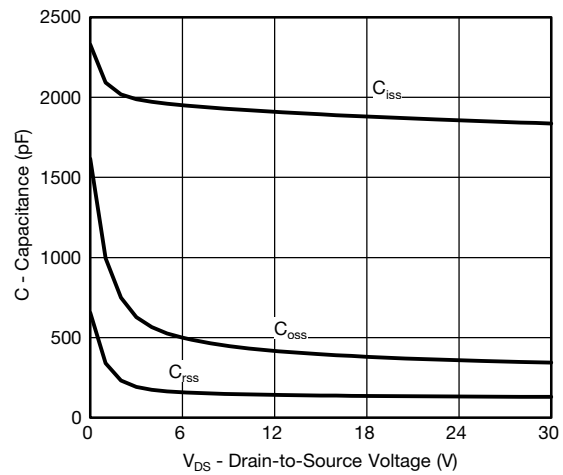

Capacitance



TYPICAL CHARACTERISTICS (T<sub>A</sub> = 25 °C, unless otherwise noted)

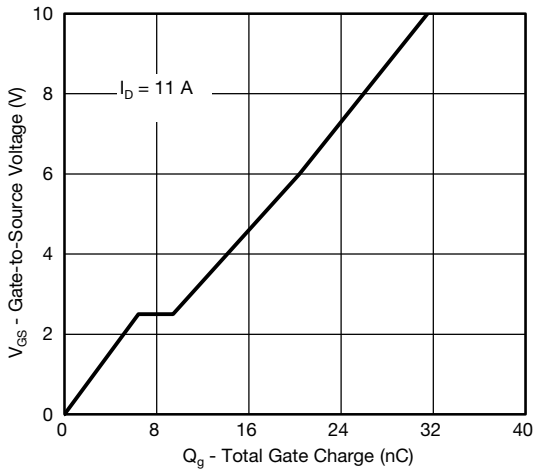

Gate Charge

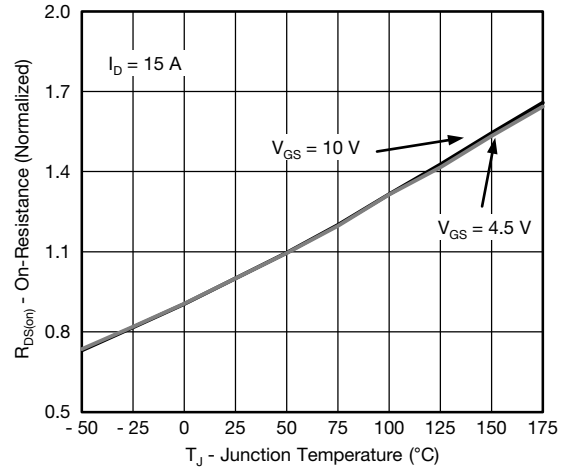

On-Resistance vs. Junction Temperature

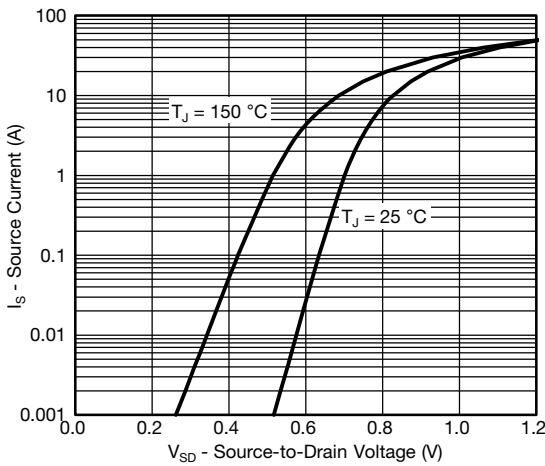

Source Drain Diode Forward Voltage

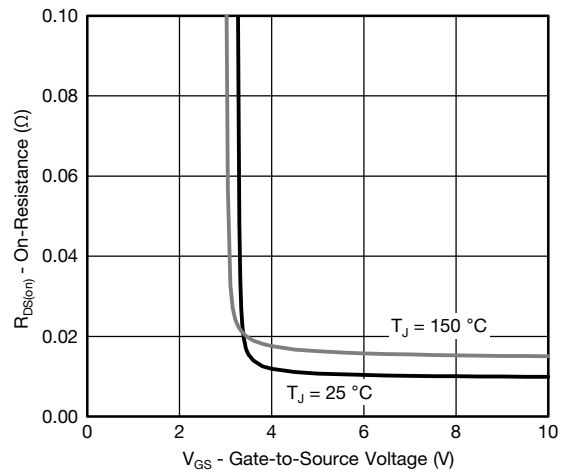

On-Resistance vs. Gate-to-Source Voltage

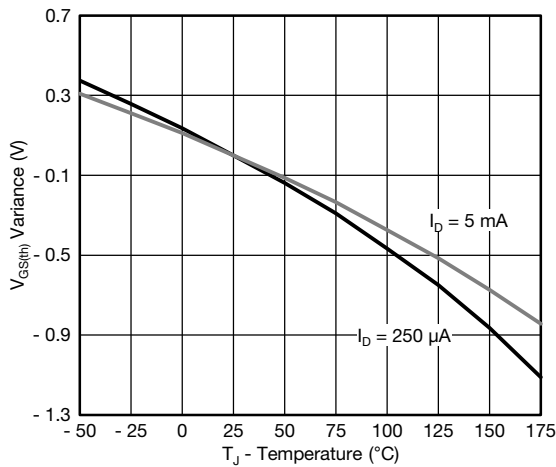

Threshold Voltage

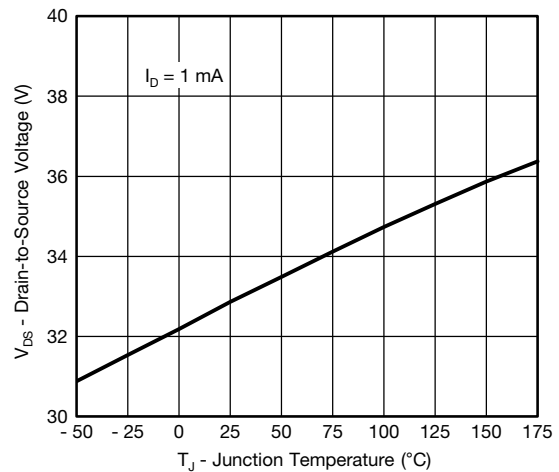

Drain Source Breakdown vs. Junction Temperature



**THERMAL RATINGS** ( $T_A = 25\text{ }^\circ\text{C}$ , unless otherwise noted)

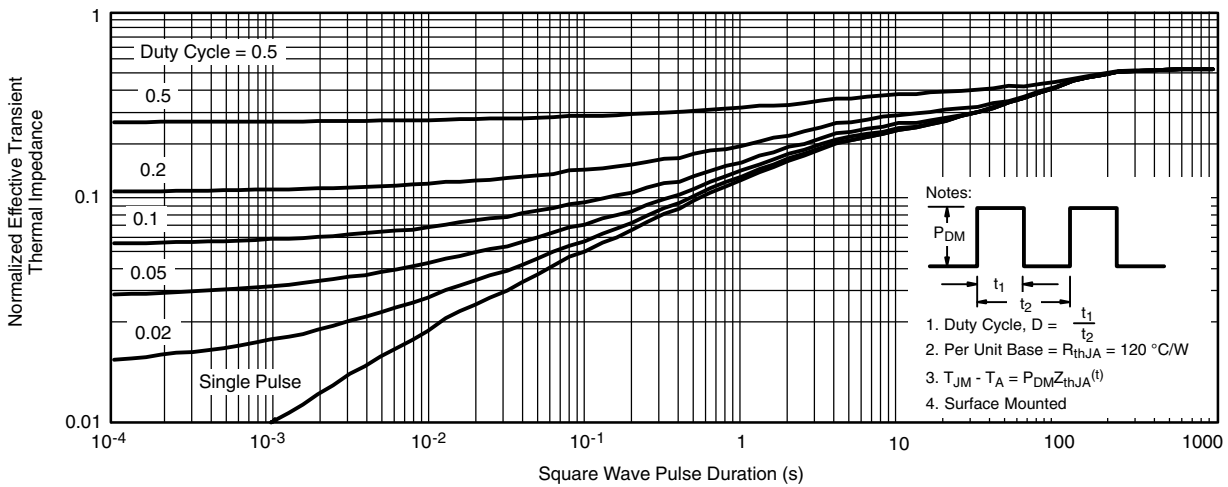
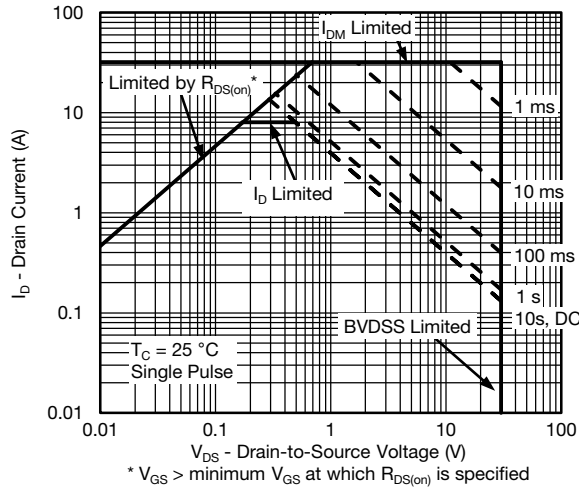



**THERMAL RATINGS** ( $T_A = 25\text{ }^\circ\text{C}$ , unless otherwise noted)

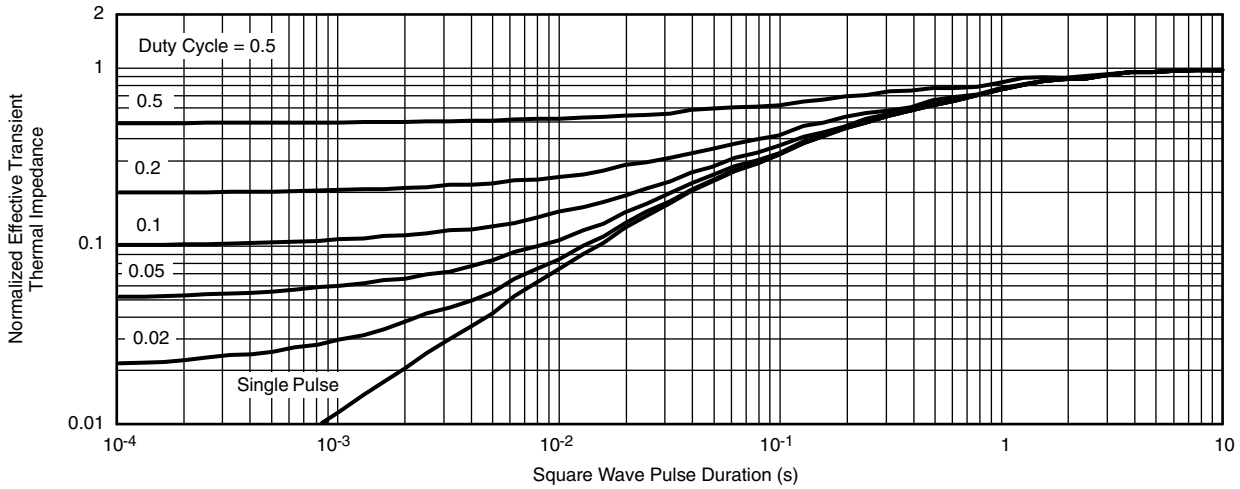

**Normalized Thermal Transient Impedance, Junction-to-Foot**

**Note**

- The characteristics shown in the two graphs
  - Normalized Transient Thermal Impedance Junction-to-Ambient (25 °C)
  - Normalized Transient Thermal Impedance Junction-to-Foot (25 °C)
 are given for general guidelines only to enable the user to get a “ball park” indication of part capabilities. The data are extracted from single pulse transient thermal impedance characteristics which are developed from empirical measurements. The latter is valid for the part mounted on printed circuit board - FR4, size 1" x 1" x 0.062", double sided with 2 oz. copper, 100 % on both sides. The part capabilities can widely vary depending on actual application parameters and operating conditions.

Vishay Siliconix maintains worldwide manufacturing capability. Products may be manufactured at one of several qualified locations. Reliability data for Silicon Technology and Package Reliability represent a composite of all qualified locations. For related documents such as package/tape drawings, part marking, and reliability data, see [www.vishay.com/ppg?63582](http://www.vishay.com/ppg?63582).

## SOIC (NARROW): 8-LEAD

JEDEC Part Number: MS-012



DIM	MILLIMETERS		INCHES	
	Min	Max	Min	Max
A	1.35	1.75	0.053	0.069
A <sub>1</sub>	0.10	0.20	0.004	0.008
B	0.35	0.51	0.014	0.020
C	0.19	0.25	0.0075	0.010
D	4.80	5.00	0.189	0.196
E	3.80	4.00	0.150	0.157
e	1.27 BSC		0.050 BSC	
H	5.80	6.20	0.228	0.244
h	0.25	0.50	0.010	0.020
L	0.50	0.93	0.020	0.037
q	0°	8°	0°	8°
S	0.44	0.64	0.018	0.026
ECN: C-06527-Rev. I, 11-Sep-06				
DWG: 5498				

## RECOMMENDED MINIMUM PADS FOR SO-8



Recommended Minimum Pads  
Dimensions in Inches/(mm)

[Return to Index](#)





## **Disclaimer**

ALL PRODUCT, PRODUCT SPECIFICATIONS AND DATA ARE SUBJECT TO CHANGE WITHOUT NOTICE TO IMPROVE RELIABILITY, FUNCTION OR DESIGN OR OTHERWISE.

Vishay Intertechnology, Inc., its affiliates, agents, and employees, and all persons acting on its or their behalf (collectively, "Vishay"), disclaim any and all liability for any errors, inaccuracies or incompleteness contained in any datasheet or in any other disclosure relating to any product.

Vishay makes no warranty, representation or guarantee regarding the suitability of the products for any particular purpose or the continuing production of any product. To the maximum extent permitted by applicable law, Vishay disclaims (i) any and all liability arising out of the application or use of any product, (ii) any and all liability, including without limitation special, consequential or incidental damages, and (iii) any and all implied warranties, including warranties of fitness for particular purpose, non-infringement and merchantability.

Statements regarding the suitability of products for certain types of applications are based on Vishay's knowledge of typical requirements that are often placed on Vishay products in generic applications. Such statements are not binding statements about the suitability of products for a particular application. It is the customer's responsibility to validate that a particular product with the properties described in the product specification is suitable for use in a particular application. Parameters provided in datasheets and / or specifications may vary in different applications and performance may vary over time. All operating parameters, including typical parameters, must be validated for each customer application by the customer's technical experts. Product specifications do not expand or otherwise modify Vishay's terms and conditions of purchase, including but not limited to the warranty expressed therein.

Except as expressly indicated in writing, Vishay products are not designed for use in medical, life-saving, or life-sustaining applications or for any other application in which the failure of the Vishay product could result in personal injury or death. Customers using or selling Vishay products not expressly indicated for use in such applications do so at their own risk. Please contact authorized Vishay personnel to obtain written terms and conditions regarding products designed for such applications.

No license, express or implied, by estoppel or otherwise, to any intellectual property rights is granted by this document or by any conduct of Vishay. Product names and markings noted herein may be trademarks of their respective owners.