

Darlington

2SD2083

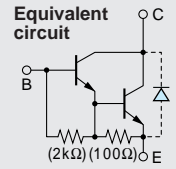

Silicon NPN Triple Diffused Planar Transistor (Complement to type 2SB1383)

Application : Driver for Solenoid, Motor and General Purpose

Absolute maximum ratings (Ta=25°C)

| Symbol | Ratings | Unit |
|------------------|---------------------------|------|
| V _{CB0} | 120 | V |
| V _{CE0} | 120 | V |
| V _{EB0} | 6 | V |
| I _C | 25(Pulse40) | A |
| I _B | 2 | A |
| P _C | 120(T _C =25°C) | W |
| T _J | 150 | °C |
| T _{stg} | -55 to +150 | °C |

Electrical Characteristics (Ta=25°C)

| Symbol | Conditions | Ratings | Unit |
|----------------------|---|---------|------|
| I _{CB0} | V _{CB} =120V | 10max | μA |
| I _{EB0} | V _{EB} =6V | 10max | mA |
| V _{(BR)CEO} | I _C =25mA | 120min | V |
| h _{FE} | V _{CE} =4V, I _C =12A | 2000min | |
| V _{CE(sat)} | I _C =12A, I _B =24mA | 1.8max | V |
| V _{BE(sat)} | I _C =12A, I _B =24mA | 2.5max | V |
| f _T | V _{CE} =12V, I _E =-1A | 20typ | MHz |
| COB | V _{CB} =10V, f=1MHz | 340typ | pF |

External Dimensions MT-100(TO3P)

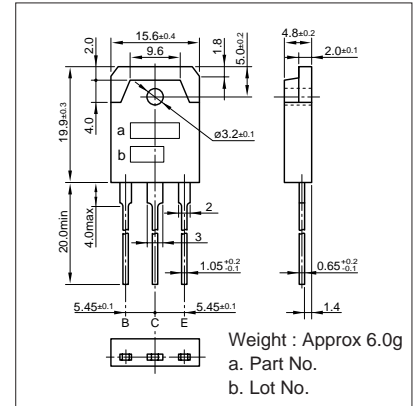

Typical Switching Characteristics (Common Emitter)

| V _{CC} (V) | R _L (Ω) | I _C (A) | V _{BB1} (V) | V _{BB2} (V) | I _{B1} (mA) | I _{B2} (mA) | t _{on} (μs) | t _{stg} (μs) | t _f (μs) |
|---------------------|--------------------|--------------------|----------------------|----------------------|----------------------|----------------------|----------------------|-----------------------|---------------------|
| 24 | 2 | 12 | 10 | -5 | 24 | -24 | 1.0typ | 6.0typ | 1.0typ |

I_C-V_{CE} Characteristics (Typical)

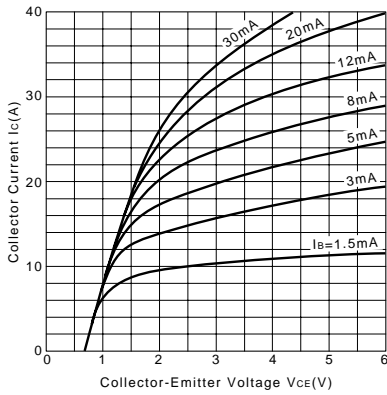

V_{CE(sat)}-I_B Characteristics (Typical)

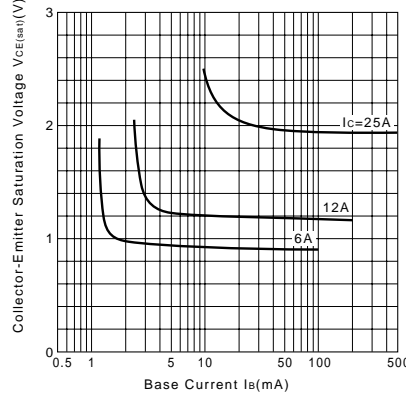

I_C-V_{BE} Temperature Characteristics (Typical)

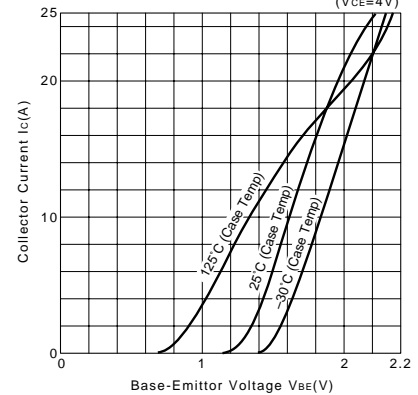

h_{FE}-I_C Characteristics (Typical)

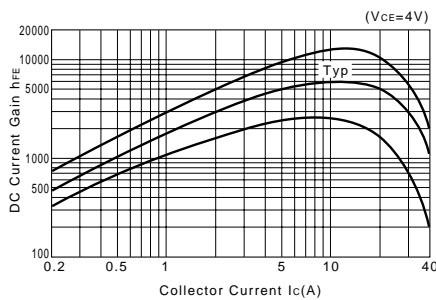

h_{FE}-I_C Temperature Characteristics (Typical)

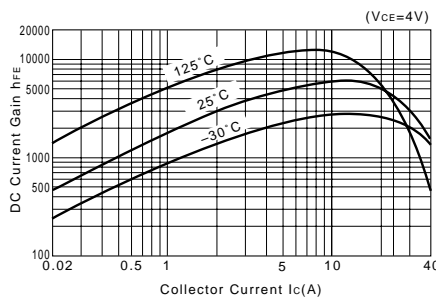

θ_{j-a}-t Characteristics

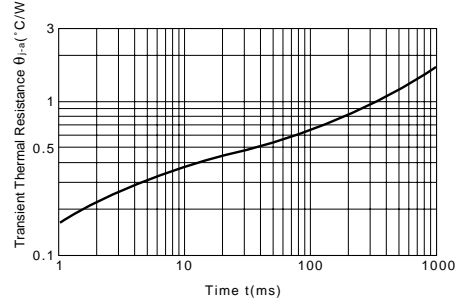

f_T-I_E Characteristics (Typical)

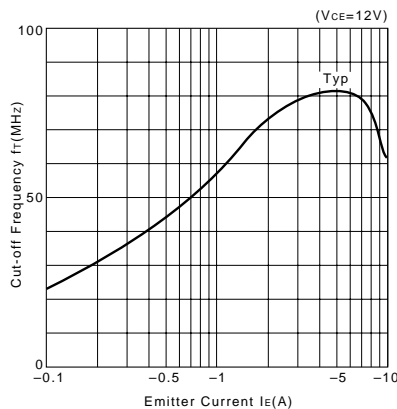

Safe Operating Area (Single Pulse)

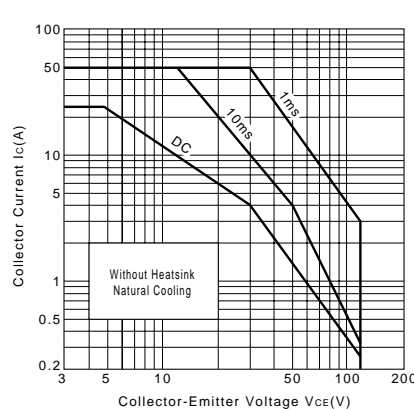

P_C-T_a Derating

