

IRF6691

HEXFET® Power MOSFET plus Schottky Diode

- Application Specific MOSFETs
- Integrates Monolithic Trench Schottky Diode
- Ideal for CPU Core DC-DC Converters
- Low Conduction Losses
- Low Reverse Recovery Losses
- Low Switching Losses
- Low Reverse Recovery Charge and Low Vf
- Low Profile (<0.7 mm)
- Dual Sided Cooling Compatible
- Compatible with existing Surface Mount Techniques

V _{DSS}	R _{DS(on)} max	Qg(typ.)
20V	2.5mΩ @ V _{GS} = 4.5V	47nC
	1.8mΩ @ V _{GS} = 10V	

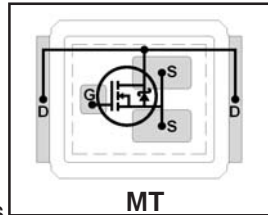

Applicable DirectFET Package/Layout Pad (see p.8,9 for details)

SQ	SX	ST		MQ	MX	MT			
----	----	----	--	----	----	-----------	--	--	--

Description

The IRF6691 combines IR's industry leading DirectFET package technology with the latest monolithic die technology, which integrates MOSFET plus free-wheeling Schottky diode. The DirectFET package is compatible with existing layout geometries used in power applications, PCB assembly equipment and vapor phase, infra-red or convection soldering techniques, when application note AN-1035 is followed regarding the manufacturing methods and processes. The DirectFET package allows dual sided cooling to maximize thermal transfer in power systems, IMPROVING previous best thermal resistance by 80%.

The IRF6691 is characterized with reduced on resistance (R_{DS(on)}), reverse recovery charge (Q_r) and source to drain voltage (V_{SD}) to reduce conduction, reverse recovery and deadtime losses. These reduced total losses along with high Cdv/dt immunity make this product ideal for high efficiency DC-DC converters that power the latest generation of processors operating at higher frequencies. The IRF6691 has been optimized for parameters that are critical for synchronous MOSFET sockets operating in 12 volt buss converters.

Absolute Maximum Ratings

	Parameter	Max.	Units
V _{DS}	Drain-to-Source Voltage	20	V
V _{GS}	Gate-to-Source Voltage	±12	
I _D @ T _C = 25°C	Continuous Drain Current, V _{GS} @ 10V	180	A
I _D @ T _A = 25°C	Continuous Drain Current, V _{GS} @ 10V	32	
I _D @ T _A = 70°C	Continuous Drain Current, V _{GS} @ 10V	26	
I _{DM}	Pulsed Drain Current ①	260	
P _D @ T _A = 25°C	Power Dissipation ⑤	2.8	W
P _D @ T _A = 70°C	Power Dissipation ⑤	1.8	
P _D @ T _C = 25°C	Power Dissipation	89	
	Linear Derating Factor	0.022	W/°C
T _J	Operating Junction and	-40 to + 150	°C
T _{STG}	Storage Temperature Range		

Thermal Resistance

	Parameter	Typ.	Max.	Units
R _{θJA}	Junction-to-Ambient ④⑥	—	45	°C/W
R _{θJA}	Junction-to-Ambient ⑤⑥	12.5	—	
R _{θJA}	Junction-to-Ambient ⑥⑥	20	—	
R _{θJC}	Junction-to-Case ⑦⑧	—	1.4	
R _{θJ-PCB}	Junction-to-PCB Mounted	1.0	—	

Notes ① through ⑧ are on page 10

Static @ T_J = 25°C (unless otherwise specified)

	Parameter	Min.	Typ.	Max.	Units	Conditions
BV _{DSS}	Drain-to-Source Breakdown Voltage	20	—	—	V	V _{GS} = 0V, I _D = 1.0mA
ΔBV _{DSS} /ΔT _J	Breakdown Voltage Temp. Coefficient	—	12	—	mV/°C	Reference to 25°C, I _D = 10mA
R _{DS(on)}	Static Drain-to-Source On-Resistance	—	1.8	2.5	mΩ	V _{GS} = 4.5V, I _D = 12A ③
		—	1.2	1.8		V _{GS} = 10V, I _D = 15A ③
V _{GS(th)}	Gate Threshold Voltage	1.6	—	2.5	V	V _{DS} = V _{GS} , I _D = 250μA
ΔV _{GS(th)} /ΔT _J	Gate Threshold Voltage Coefficient	—	-4.1	—	mV/°C	I _D = 10mA, reference to 25°C
I _{DSS}	Drain-to-Source Leakage Current	—	—	1.4	mA	V _{DS} = 20V, V _{GS} = 0V
		—	—	500	μA	V _{DS} = 16V, V _{GS} = 0V
		—	—	5	mA	V _{DS} = 16V, V _{GS} = 0V, T _J = 125°C
I _{GSS}	Gate-to-Source Forward Leakage	—	—	100	nA	V _{GS} = 12V
	Gate-to-Source Reverse Leakage	—	—	-100	nA	V _{GS} = -12V
g _{fs}	Forward Transconductance	110	—	—	S	V _{DS} = 10V, I _D = 26A
Q _g	Total Gate Charge	—	47	71	nC	V _{DS} = 10V V _{GS} = 4.5V I _D = 17A See Fig. 17
Q _{gs1}	Pre-V _{th} Gate-to-Source Charge	—	14	—		
Q _{gs2}	Post-V _{th} Gate-to-Source Charge	—	4.4	—		
Q _{gd}	Gate-to-Drain Charge	—	15	—		
Q _{godr}	Gate Charge Overdrive	—	14	—		
Q _{sw}	Switch Charge (Q _{gs2} + Q _{gd})	—	19	—		
Q _{oss}	Output Charge	—	30	—	nC	V _{DS} = 10V, V _{GS} = 0V
R _G	Gate Resistance	—	0.60	1.5	Ω	
t _{d(on)}	Turn-On Delay Time	—	23	—	ns	V _{DD} = 16V, V _{GS} = 4.5V ③ I _D = 26A Clamped Inductive Load
t _r	Rise Time	—	95	—		
t _{d(off)}	Turn-Off Delay Time	—	25	—		
t _f	Fall Time	—	10	—		
C _{iss}	Input Capacitance	—	6580	—	pF	V _{GS} = 0V V _{DS} = 10V f = 1.0MHz
C _{oss}	Output Capacitance	—	2070	—		
C _{rss}	Reverse Transfer Capacitance	—	840	—		

Avalanche Characteristics

	Parameter	Typ.	Max.	Units
E _{AS}	Single Pulse Avalanche Energy ^②	—	230	mJ
I _{AR}	Avalanche Current ①	—	26	A

Diode Characteristics

	Parameter	Min.	Typ.	Max.	Units	Conditions
I _S	Continuous Source Current (Body Diode)	—	—	32	A	MOSFET symbol showing the integral reverse p-n junction diode.
I _{SM}	Pulsed Source Current (Body Diode) ①	—	—	260		
V _{SD}	Diode Forward Voltage	—	—	0.65	V	T _J = 25°C, I _S = 25A, V _{GS} = 0V ③
t _{rr}	Reverse Recovery Time	—	32	48	ns	T _J = 25°C, I _F = 25A
Q _{rr}	Reverse Recovery Charge	—	26	39	nC	di/dt = 100A/μs ③

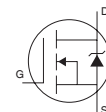

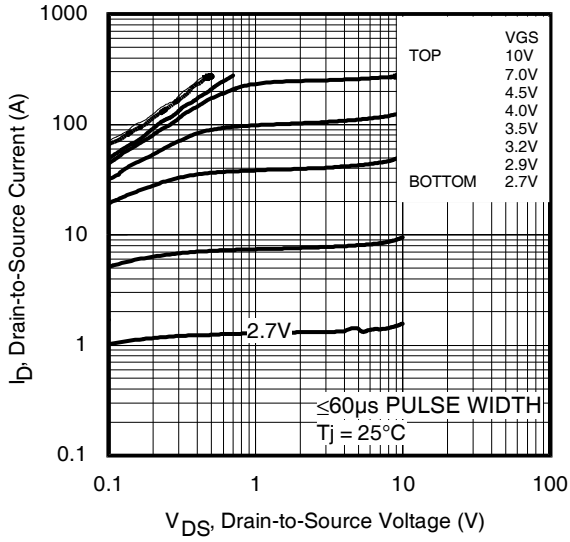

Fig 1. Typical Output Characteristics

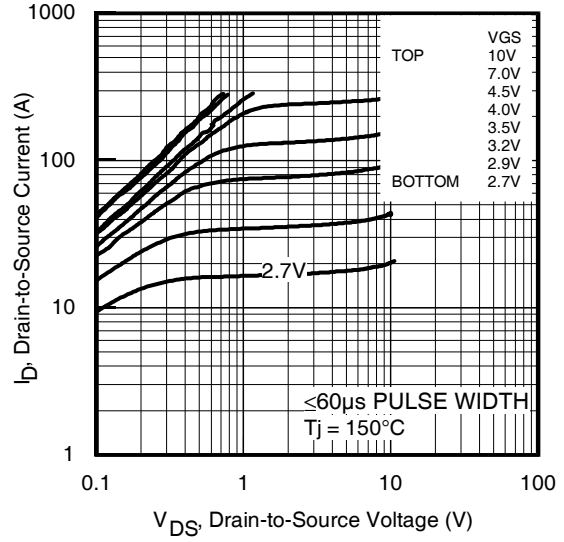

Fig 2. Typical Output Characteristics

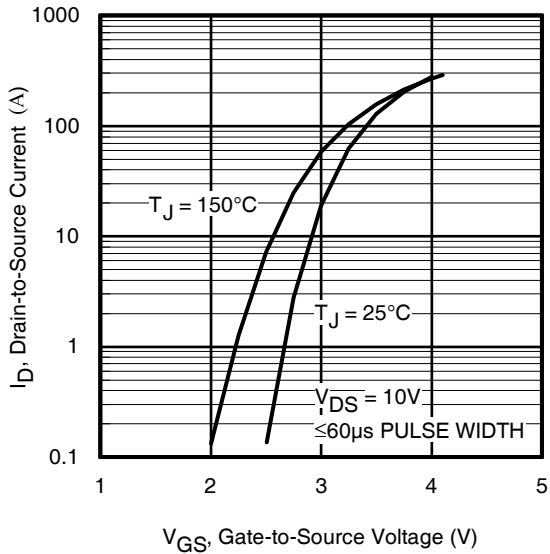

Fig 3. Typical Transfer Characteristics

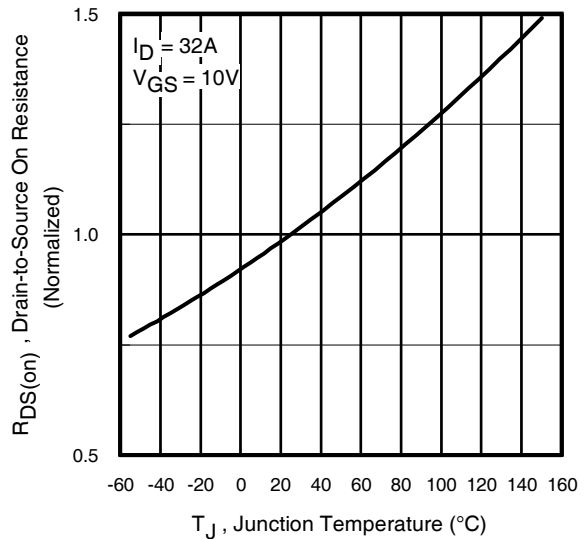

Fig 4. Normalized On-Resistance vs. Temperature

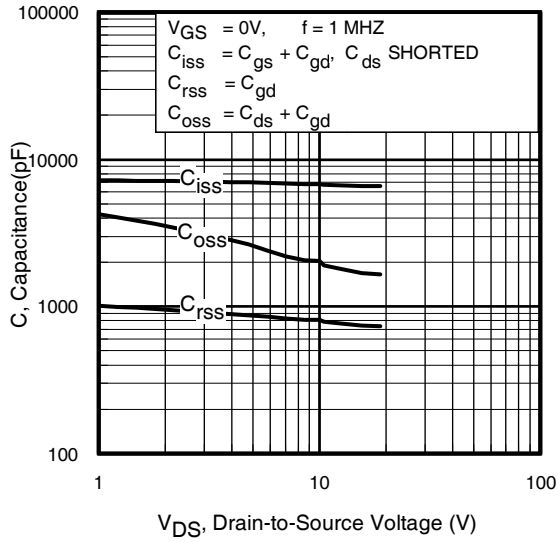

Fig 5. Typical Capacitance vs. Drain-to-Source Voltage

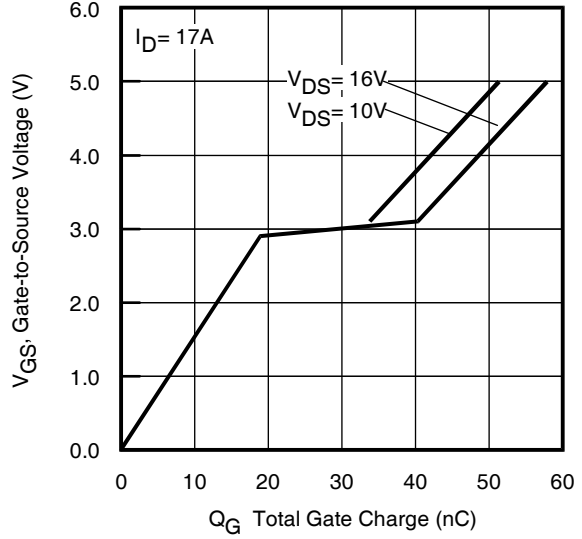

Fig 6. Typical Gate Charge vs. Gate-to-Source Voltage

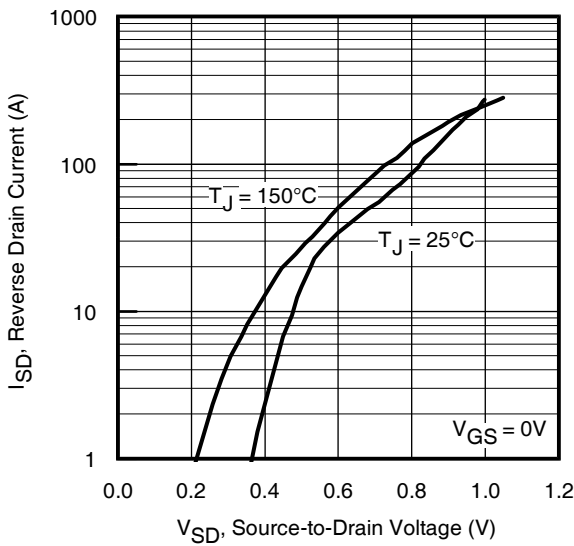

Fig 7. Typical Source-Drain Diode Forward Voltage

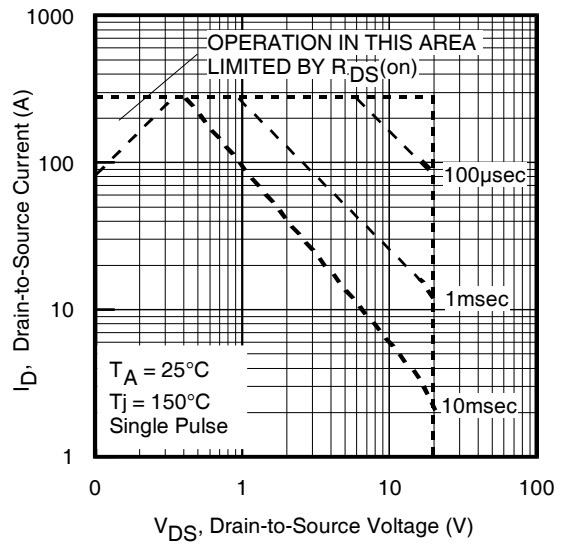

Fig 8. Maximum Safe Operating Area

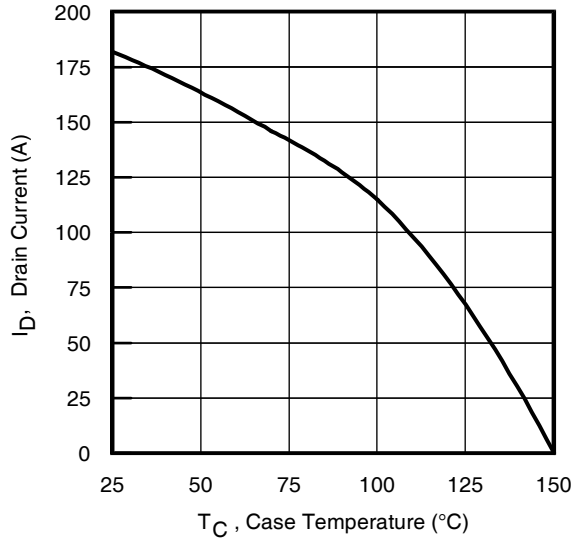

Fig 9. Maximum Drain Current vs. Case Temperature

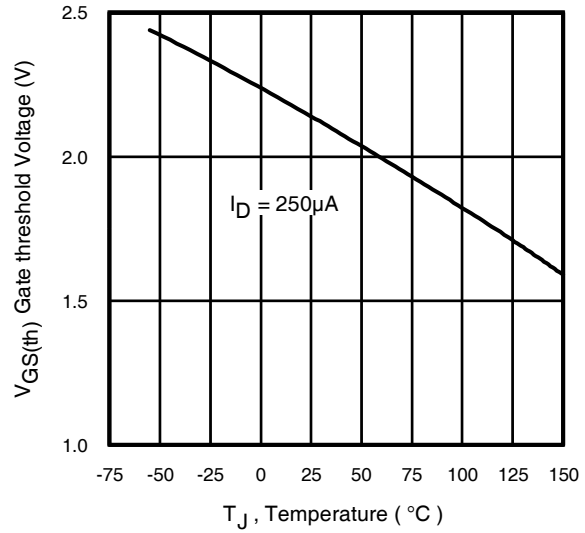

Fig 10. Threshold Voltage vs. Temperature

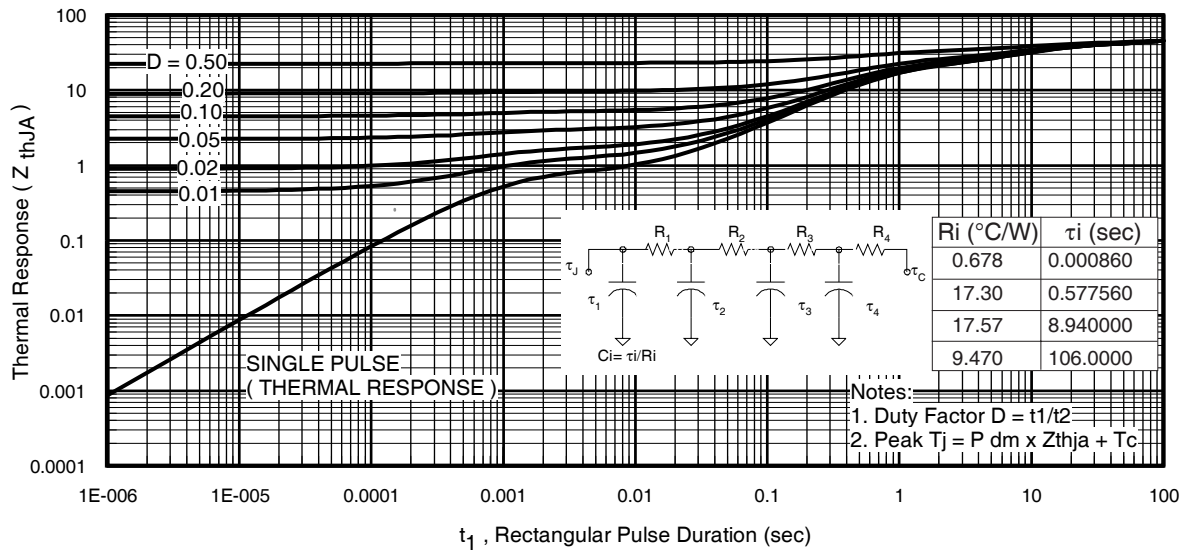

Fig 11. Maximum Effective Transient Thermal Impedance, Junction-to-Ambient

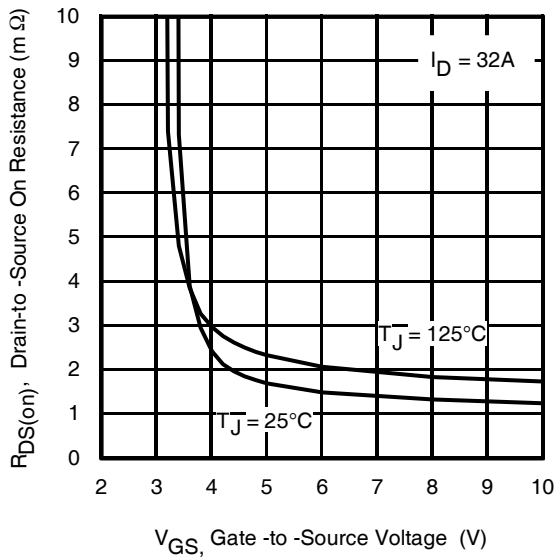

Fig 12. On-Resistance vs. Gate Voltage

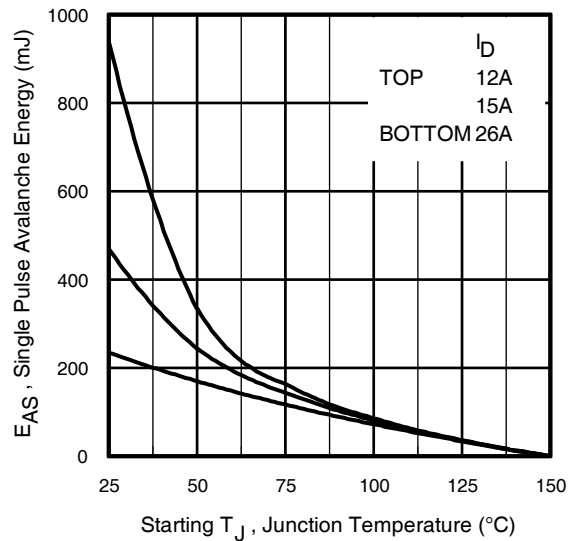

Fig 13c. Maximum Avalanche Energy vs. Drain Current

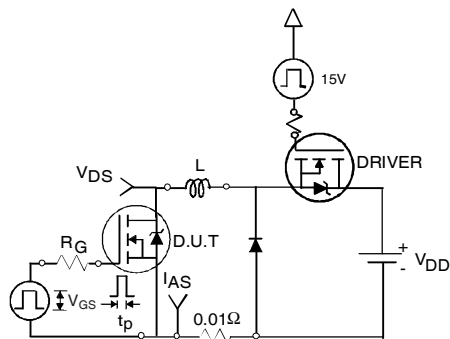

Fig 13a. Unclamped Inductive Test Circuit

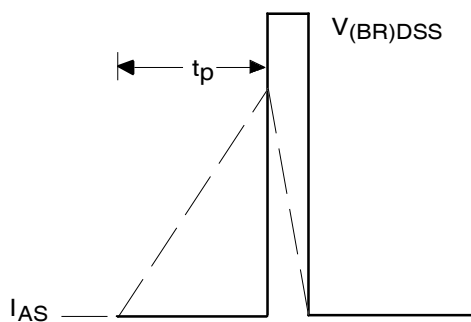

Fig 13b. Unclamped Inductive Waveforms

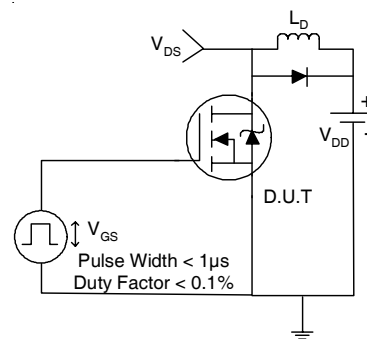

Fig 14a. Switching Time Test Circuit

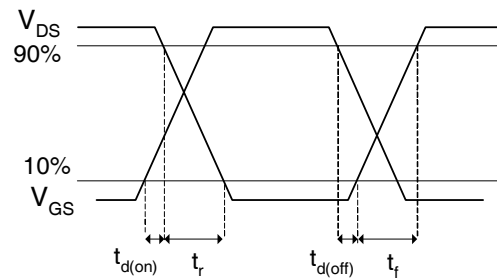

Fig 14b. Switching Time Waveforms

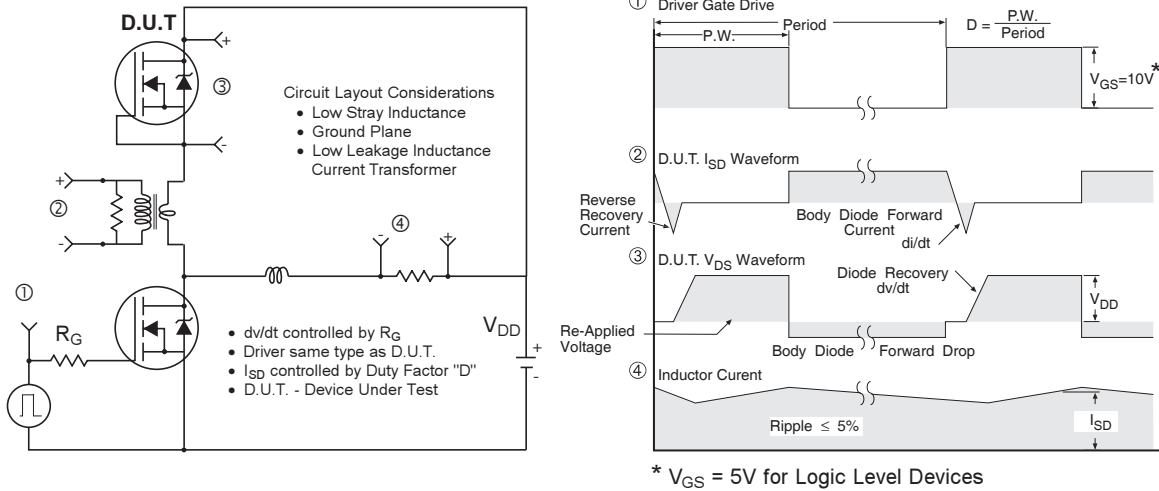

Fig 15. Peak Diode Recovery dv/dt Test Circuit for N-Channel HEXFET® Power MOSFETs

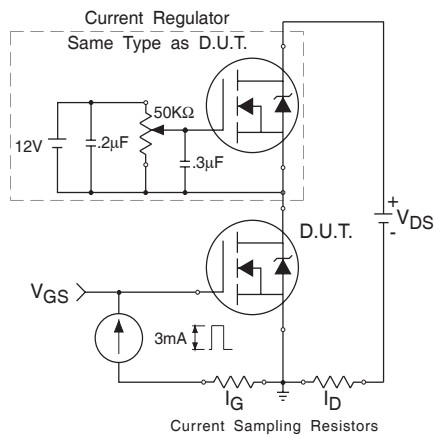

Fig 16. Gate Charge Test Circuit

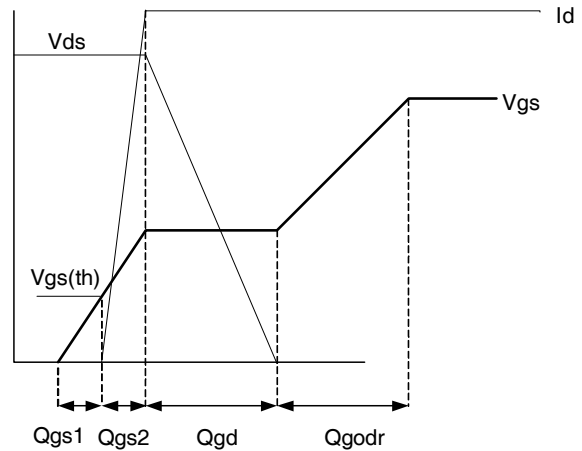
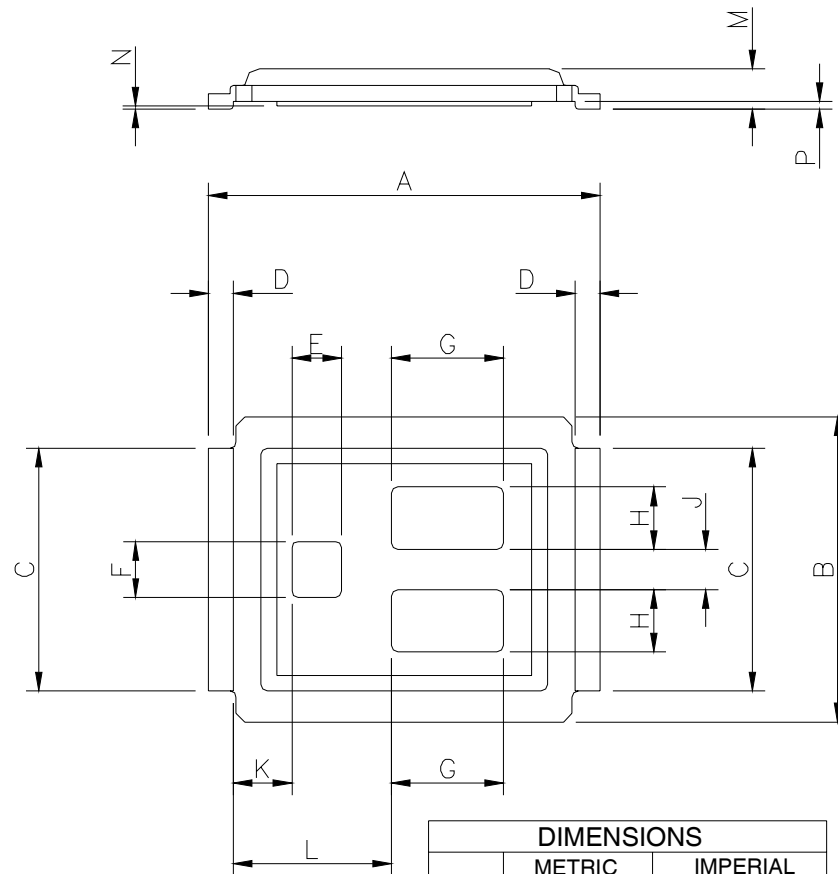

Fig 17. Gate Charge Waveform

DirectFET™ Outline Dimension, MT Outline (Medium Size Can, T-Designation).

Please see DirectFET application note AN-1035 for all details regarding the assembly of DirectFET. This includes all recommendations for stencil and substrate designs.



NOTE: CONTROLLING
DIMENSIONS ARE IN MM

DIMENSIONS				
CODE	METRIC		IMPERIAL	
	MIN	MAX	MIN	MAX
A	6.25	6.35	0.246	0.250
B	4.80	5.05	0.189	0.199
C	3.85	3.95	0.152	0.156
D	0.35	0.45	0.014	0.018
E	0.78	0.82	0.031	0.032
F	0.88	0.92	0.035	0.036
G	1.78	1.82	0.070	0.072
H	0.98	1.02	0.039	0.040
J	0.63	0.67	0.025	0.026
K	0.88	1.01	0.035	0.039
L	2.46	2.63	0.097	0.104
M	0.59	0.70	0.023	0.028
N	0.03	0.08	0.001	0.003
P	0.08	0.17	0.003	0.007

DirectFET™ Board Footprint, MT Outline (Medium Size Can, T-Designation).

Please see DirectFET application note AN-1035 for all details regarding the assembly of DirectFET. This includes all recommendations for stencil and substrate designs.

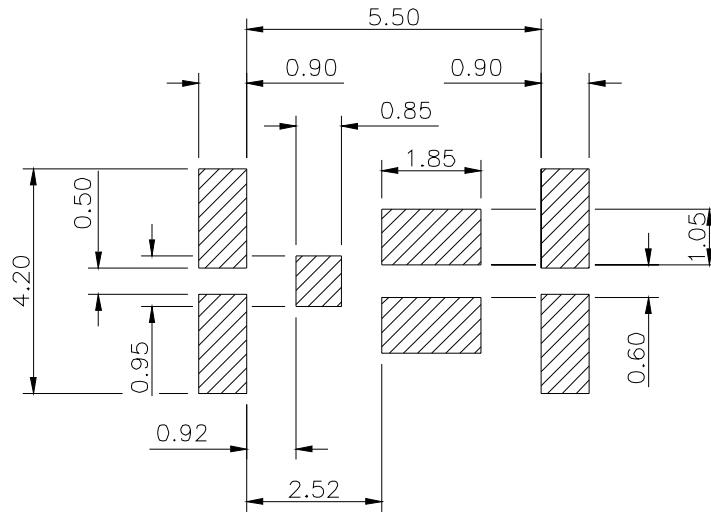

DirectFET™ Tape & Reel Dimension (Showing component orientation).

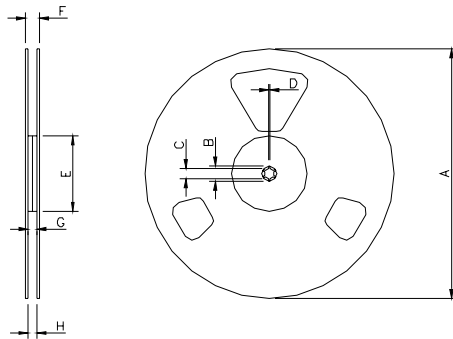

NOTE: Controlling dimensions in mm
 Std reel quantity is 4800 parts. (ordered as IRF6691). For 1000 parts on 7" reel,
 order IRF6691TR1

REEL DIMENSIONS								
STANDARD OPTION (QTY 4800)				TR1 OPTION (QTY 1000)				
CODE	METRIC		IMPERIAL		METRIC		IMPERIAL	
	MIN	MAX	MIN	MAX	MIN	MAX	MIN	MAX
A	330.0	N.C	12.992	N.C	177.77	N.C	6.9	N.C
B	20.2	N.C	0.795	N.C	19.06	N.C	0.75	N.C
C	12.8	13.2	0.504	0.520	13.5	12.8	0.53	0.50
D	1.5	N.C	0.059	N.C	1.5	N.C	0.059	N.C
E	100.0	N.C	3.937	N.C	58.72	N.C	2.31	N.C
F	N.C	18.4	N.C	0.724	N.C	13.50	N.C	0.53
G	12.4	14.4	0.488	0.567	11.9	12.01	0.47	N.C
H	11.9	15.4	0.469	0.606	11.9	12.01	0.47	N.C

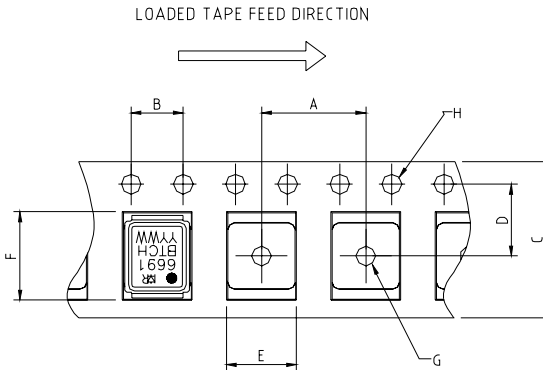

NOTE: CONTROLLING DIMENSIONS IN MM

CODE	DIMENSIONS			
	METRIC		IMPERIAL	
	MIN	MAX	MIN	MAX
A	7.90	8.10	0.311	0.319
B	3.90	4.10	0.154	0.161
C	11.90	12.30	0.469	0.484
D	5.45	5.55	0.215	0.219
E	5.10	5.30	0.201	0.209
F	6.50	6.70	0.256	0.264
G	1.50	N.C	0.059	N.C
H	1.50	1.60	0.059	0.063

IRF6691

International
IR Rectifier

DirectFET™ Part Marking

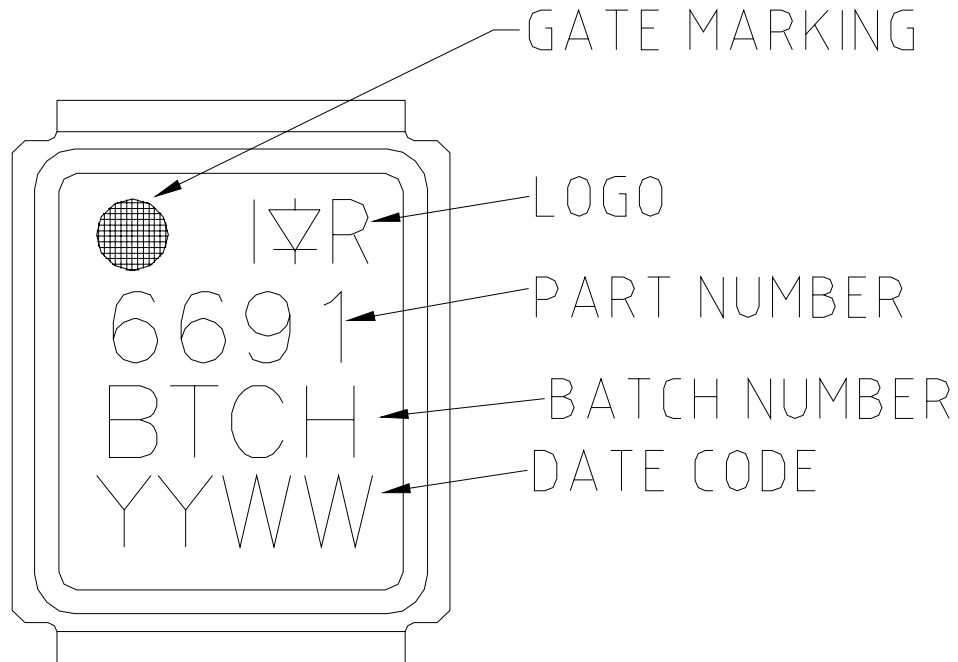

Notes:

- ① Repetitive rating; pulse width limited by max. junction temperature.
- ② Starting $T_J = 25^\circ\text{C}$, $L = 0.72\text{mH}$, $R_G = 25\Omega$, $I_{AS} = 26\text{A}$.
- ③ Pulse width $\leq 400\mu\text{s}$; duty cycle $\leq 2\%$.
- ④ Surface mounted on 1 in. square Cu board.
- ⑤ Used double sided cooling , mounting pad.
- ⑥ Mounted on minimum footprint full size board with metalized back and with small clip heatsink.
- ⑦ T_C measured with thermal couple mounted to top (Drain) of part.
- ⑧ R_θ is measured at T_J of approximately 90°C .

Data and specifications subject to change without notice.
This product has been designed and qualified for the Industrial market.
Qualification Standards can be found on IR's Web site.

International
IR Rectifier

IR WORLD HEADQUARTERS: 233 Kansas St., El Segundo, California 90245, USA Tel: (310) 252-7105
TAC Fax: (310) 252-7903

Visit us at www.irf.com for sales contact information.04/04

www.irf.com