

MPW1000 Series

25-30W, Wide Input Range, Single & Dual Output DC/DC Converters

Key Features

- Efficiency up to 89%
- 1500VDC Isolation
- MTBF > 1,000,000 Hours
- CSA1950 Safety Approval
- Complies with EN55022 Class A
- Six-Sided Shielding
- Remote On/Off Control
- Over Voltage Protection
- Over Temperature Protection
- Output Trim
- Low Profile: 0.37"(9.3mm)
- Soft Start



Minmax's MPW1000-Series power modules are low-profile dc-dc converters that operate over input voltage ranges of 9-18VDC, 18-36VDC and 36-75VDC which provide precisely regulated output voltages of 3.3V, 5V, 12V, 15V, $\pm 12V$ and $\pm 15VDC$, specially addressing data communication equipments, mobile battery driven equipments, distributed power systems, telecommunication equipments, mixed analog/digital subsystems, process/machine control equipments, computer peripheral systems and industrial robot systems.

Packing up to 30W of power into a 2x1.6x0.37inch package, with efficiencies as high as 89%, the MPW1000 includes continuous short circuit protection, overvoltage protection, over temperature protection, output trim function, remote on/off, six-sided shielded case and EN55022 Class A conducted noise compliance minimize design-in time, cost and eliminate the need for external filtering.



Protection



Protection

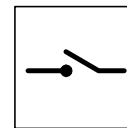

Remote on/off

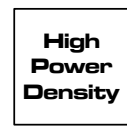

More Power

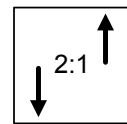

Wide Range

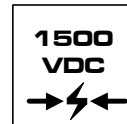

I/O Isolation



EN55022

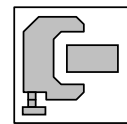

Low Profile

Block Diagram

Single Output

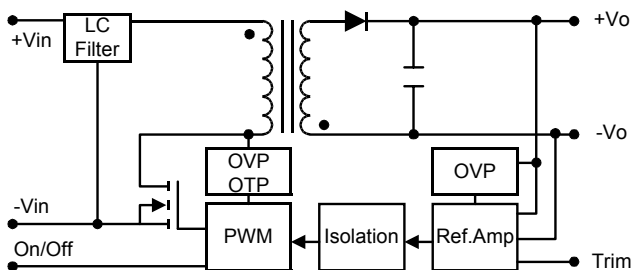

Dual Output

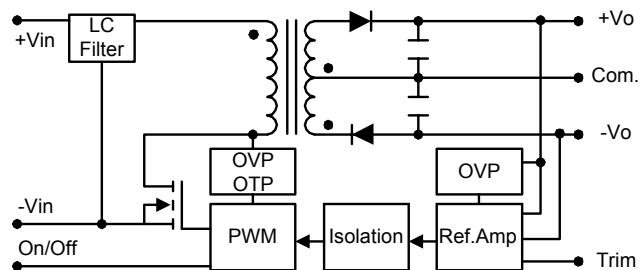

Model Selection Guide

Model Number	Input Voltage	Output Voltage	Output Current		Input Current		Reflected Ripple Current	Over Voltage Protection	Efficiency
			Max.	Min.	@Max. Load	@No Load			@Max. Load
	VDC	VDC	mA	mA	mA (Typ.)	mA (Typ.)	mA (Typ.)	VDC	% (Typ.)
MPW1021	12 (9 ~ 18)	3.3	5500	400	1867	40	100	3.9	81
MPW1022		5	5000	350	2480			6.8	84
MPW1023		12	2500	166	2841			15	88
MPW1024		15	2000	133	2841			18	88
MPW1026		±12	±1250	±83	2841			±15	88
MPW1027		±15	±1000	±65	2841			±18	88
MPW1031	24 (18 ~ 36)	3.3	5500	400	922	20	50	3.9	82
MPW1032		5	5000	350	1225			6.8	85
MPW1033		12	2500	166	1404			15	89
MPW1034		15	2000	133	1404			18	89
MPW1036		±12	±1250	±83	1404			±15	89
MPW1037		±15	±1000	±65	1404			±18	89
MPW1041	48 (36 ~ 75)	3.3	5500	400	461	10	25	3.9	82
MPW1042		5	5000	350	613			6.8	85
MPW1043		12	2500	166	702			15	89
MPW1044		15	2000	133	702			18	89
MPW1046		±12	±1250	±83	702			±15	89
MPW1047		±15	±1000	±65	702			±18	89

Absolute Maximum Ratings

Parameter	Min.	Max.	Unit	
Input Surge Voltage (1000 mS)	12VDC Input Models	-0.7	25	VDC
	24VDC Input Models	-0.7	50	VDC
	48VDC Input Models	-0.7	100	VDC
Lead Temperature (1.5mm from case for 10 Sec.)	---	260	°C	
Internal Power Dissipation	---	5500	mW	

Exceeding the absolute maximum ratings of the unit could cause damage. These are not continuous operating ratings.

Notes :

- Specifications typical at Ta=+25°C, resistive load, nominal input voltage, rated output current unless otherwise noted.
- Transient recovery time is measured to within 1% error band for a step change in output load of 75% to 100%.
- Ripple & Noise measurement bandwidth is 0-20 MHz.
- These power converters require a minimum output loading to maintain specified regulation.
- Operation under no-load conditions will not damage these modules; however, they may not meet all specifications listed.
- All DC/DC converters should be externally fused at the front end for protection.
- Other input and output voltage may be available, please contact factory.
- Specifications subject to change without notice.

Environmental Specifications

Parameter	Conditions	Min.	Max.	Unit
Operating Temperature	Ambient	-40	+50	°C
Operating Temperature	Case	-40	+105	°C
Storage Temperature		-50	+125	°C
Humidity		---	95	%
Cooling	Free-Air Convection			
RFI	Six-Sided Shielded, Metal Case			
Conducted EMI	EN55022 Class A			

Input Specifications

Parameter	Model	Min.	Typ.	Max.	Unit
Start Voltage	12V Input Models	8.6	8.8	9	VDC
	24V Input Models	17	17.5	18	
	48V Input Models	34	35	36	
Under Voltage Shutdown	12V Input Models	8.1	8.3	8.5	
	24V Input Models	16	16.5	17	
	48V Input Models	32	33	34	
Reverse Polarity Input Current	All Models	---	---	2	A
Short Circuit Input Power		---	---	4500	mW
Input Filter		Pi Filter			

Output Specifications

Parameter	Conditions	Min.	Typ.	Max.	Unit
Output Voltage Accuracy		---	± 0.5	± 1.0	%
Output Voltage Balance	Dual Output, Balanced Loads	---	± 0.5	± 2.0	%
Line Regulation	Vin=Min. to Max.	---	± 0.1	± 0.3	%
Load Regulation	Io=10% to 100%	---	± 0.1	± 0.5	%
Ripple & Noise (20MHz)		---	55	80	mV P-P
Ripple & Noise (20MHz)	Over Line, Load & Temp.	---	---	100	mV P-P
Ripple & Noise (20MHz)		---	---	10	mV rms
Over Power Protection		110	---	160	%
Transient Recovery Time	25% Load Step Change	---	150	300	μ S
Transient Response Deviation		---	± 2	± 4	%
Temperature Coefficient		---	± 0.01	± 0.02	%/°C
Output Short Circuit	Continuous				

General Specifications

Parameter	Conditions	Min.	Typ.	Max.	Unit
Isolation Voltage Rated	60 Seconds	1500	---	---	VDC
Isolation Voltage Test	Flash Tested for 1 Second	1650	---	---	VDC
Isolation Resistance	500VDC	1000	---	---	M Ω
Isolation Capacitance	100KHz, 1V	---	1200	1500	pF
Switching Frequency		290	330	360	KHz
Over Temperature Protection	Case Temperature, automatic recovery	107	112	117	°C
MTBF	MIL-HDBK-217F @ 25°C, Ground Benign	1000	---	---	K Hours

Remote On/Off Control

Parameter	Conditions	Min.	Typ.	Max.	Unit
Supply On	2.5 to 100VDC or Open Circuit				VDC
Supply Off		-1	---	1	VDC
Device Standby Input Current		---	2	5	mA
Control Input Current (on)	Vin -RC = 5.0V	---	---	5	μ A
Control Input Current (off)	Vin -RC = 0V	---	---	-100	μ A
Control Common	Referenced to Negative Input				

Capacitive Load

Models by Vout	3.3V	5V	12V	15V	±12V #	±15V #	Unit
Maximum Capacitive Load	10000	10000	1000	1000	330	330	uF

For each output

Input Fuse Selection Guide

12V Input Models	24V Input Models	48V Input Models
6000mA Slow – Blow Type	3000mA Slow – Blow Type	1500mA Slow – Blow Type

Output Voltage Trim

Parameter	Conditions	Min.	Typ.	Max.	Unit
Trim Up / Down Range	% of nominal output voltage	±9.0	±10.0	±11.0	%

Input Voltage Transient Rating

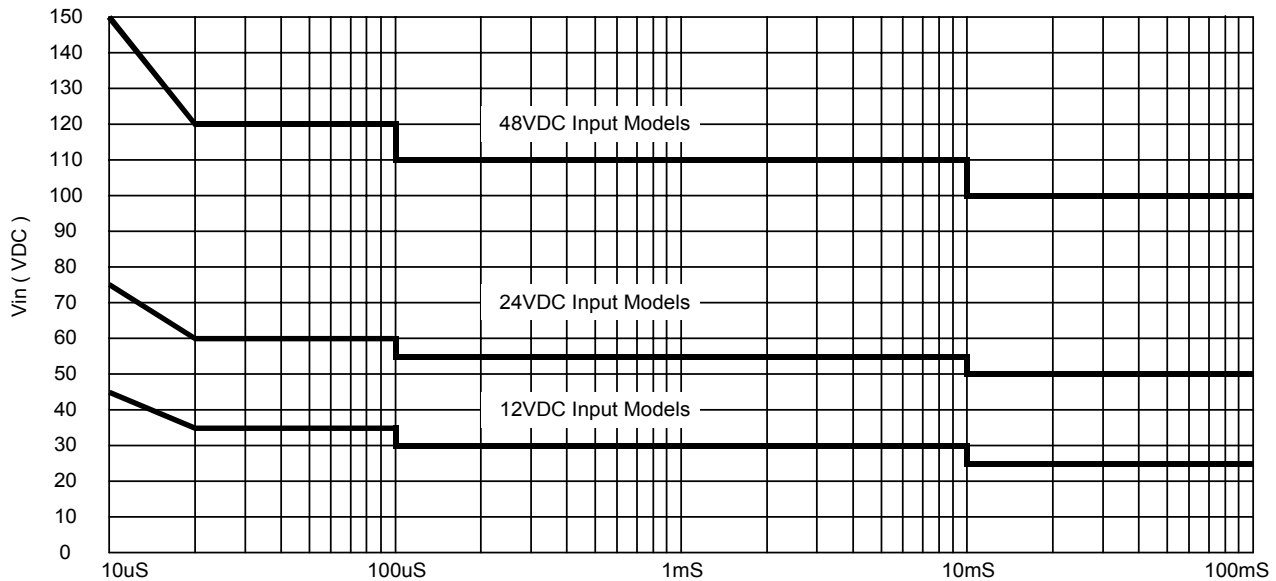

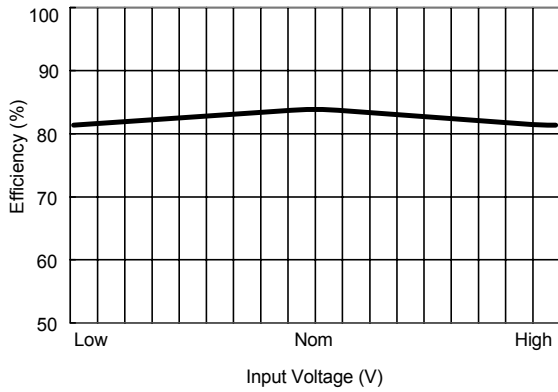

Efficiency vs Input Voltage (Single Output)

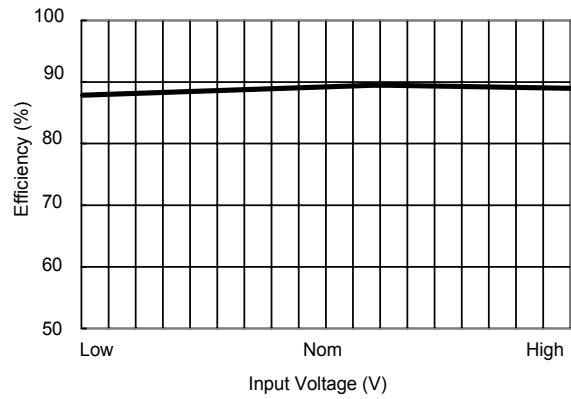

Efficiency vs Input Voltage (Dual Output)

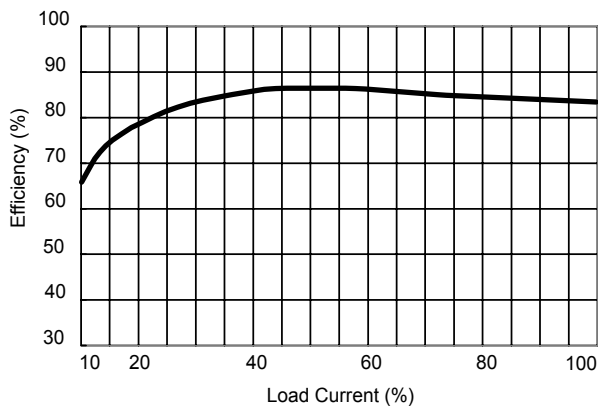

Efficiency vs Output Load (Single Output)

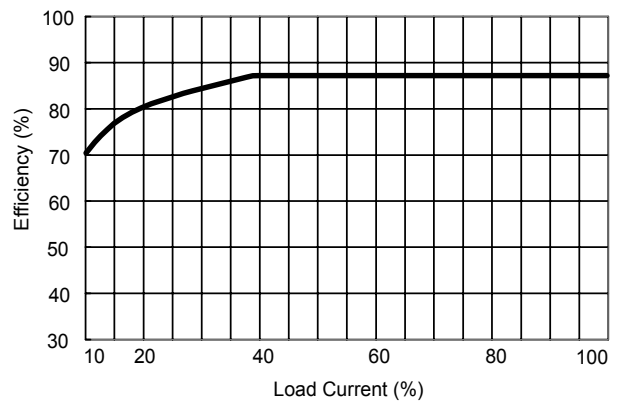

Efficiency vs Output Load (Dual Output)

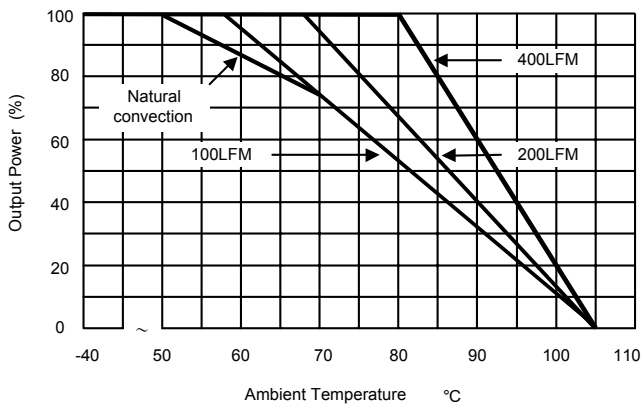

Derating Curve

Test Configurations

Input Reflected-Ripple Current Test Setup

Input reflected-ripple current is measured with an inductor L_{in} (4.7uH) and C_{in} (220uF, ESR < 1.0Ω at 100 KHz) to simulate source impedance.

Capacitor C_{in} , offsets possible battery impedance.

Current ripple is measured at the input terminals of the module, measurement bandwidth is 0–500 KHz.

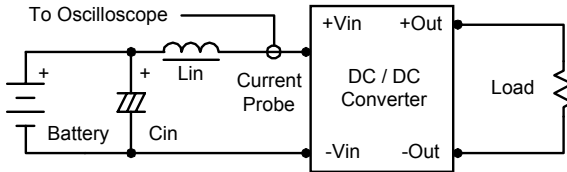

Peak-to-Peak Output Noise Measurement Test

Use a C_{out} 1.0uF ceramic capacitor.

Scope measurement should be made by using a BNC socket, measurement bandwidth is 0–20 MHz. Position the load between 50 mm and 75 mm from the DC/DC Converter.

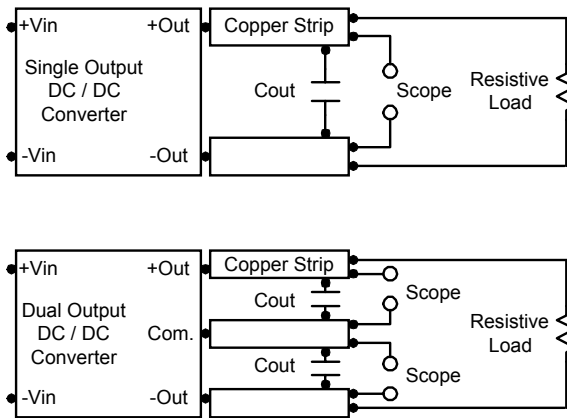

Design & Feature Considerations

Remote On/Off

Positive logic remote on/off turns the module on during a logic high voltage on the remote on/off pin, and off during a logic low.

To turn the power module on and off, the user must supply a switch to control the voltage between the on/off terminal and the $-V_{in}$ terminal.

The switch can be an open collector or equivalent.

A logic low is $-1V$ to $1.0V$.

A logic high is $2.5V$ to $100V$.

The maximum sink current at the on/off terminal (Pin 4) during a logic low is $-100 \mu A$.

The maximum allowable leakage current of a switch connected to the on/off terminal (Pin 4) at logic high ($2.5V$ to $100V$) is $5 \mu A$.

Output Voltage Trim

Output voltage trim allows the user to increase or decrease the output voltage set point of a module.

The output voltage can be adjusted by placing an external resistor (R_{adj}) between the Trim and $+V_{out}$ or $-V_{out}$ terminals. By adjusting R_{adj} , the output voltage can be change by $\pm 10\%$ of the nominal output voltage.

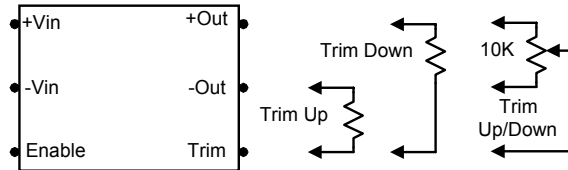

A 10K, 1 or 10 Turn trimpot is usually specified for continuous trimming. Trim pin may be safely left floating if it is not used.

Connecting the external resistor (R_{adj-up}) between the Trim and $-V_{out}$ pins increases the output voltage to set the point as defined in the following equation:

$$R_{adj-up} = \frac{(33 \times V_{out}) - (30 \times V_{adj})}{V_{adj} - V_{out}}$$

Connecting the external resistor ($R_{adj-down}$) between the Trim and $+V_{out}$ pins decreases the output voltage set point as defined in the following equation:

$$R_{adj-down} = \frac{(36.667 \times V_{adj}) - (33 \times V_{out})}{V_{out} - V_{adj}}$$

V_{out} : Nominal Output Voltage

V_{adj} : Adjusted Output Voltage

Units : VDC/ $K\Omega$

Overcurrent Protection

To provide protection in a fault (output overload) condition, the unit is equipped with internal current limiting circuitry and can endure current limiting for an unlimited duration. At the point of current-limit inception, the unit shifts from voltage control to current control. The unit operates normally once the output current is brought back into its specified range.

Overvoltage Protection

The output overvoltage clamp consists of control circuitry, which is independent of the primary regulation loop, that monitors the voltage on the output terminals.

The control loop of the clamp has a higher voltage set point than the primary loop.

This provides a redundant voltage control that reduces the risk of output overvoltage.

The OVP level can be found in the output data.

Input Source Impedance

The power module should be connected to a low ac-impedance input source. Highly inductive source impedances can affect the stability of the power module.

In applications where power is supplied over long lines and output loading is high, it may be necessary to use a capacitor at the input to ensure startup.

Capacitor mounted close to the power module helps ensure stability of the unit, it is recommended to use a good quality low Equivalent Series Resistance (ESR <math>< 1.0\Omega</math> at 100 KHz) capacitor of a 33uF for the 12V input devices and a 10uF for the 24V and 48V devices.

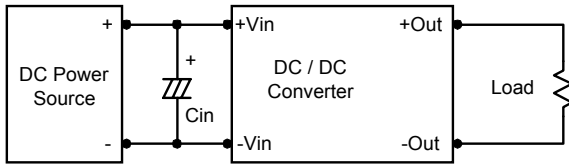

Output Ripple Reduction

A good quality low ESR capacitor placed as close as practicable across the load will give the best ripple and noise performance.

To reduce output ripple, it is recommended to use 4.7uF capacitors at the output.

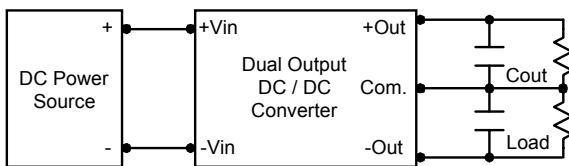
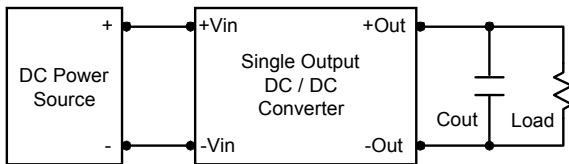

Maximum Capacitive Load

The MPW1000 series has limitation of maximum connected capacitance at the output.

The power module may be operated in current limiting mode during start-up, affecting the ramp-up and the startup time.

For optimum performance we recommend 330uF maximum capacitive load for dual outputs, 1000uF capacitive load for 12V & 15V outputs and 10000uF capacitive load for 3.3V & 5V outputs.

The maximum capacitance can be found in the data sheet.

Thermal Considerations

Many conditions affect the thermal performance of the power module, such as orientation, airflow over the module and board spacing. To avoid exceeding the maximum temperature rating of the components inside the power module, the case temperature must be kept below 105°C.

The derating curves are determined from measurements obtained in an experimental apparatus.

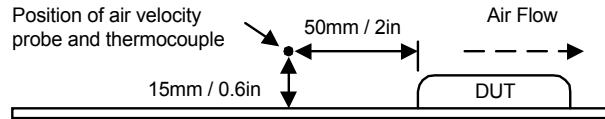

Mechanical Dimensions

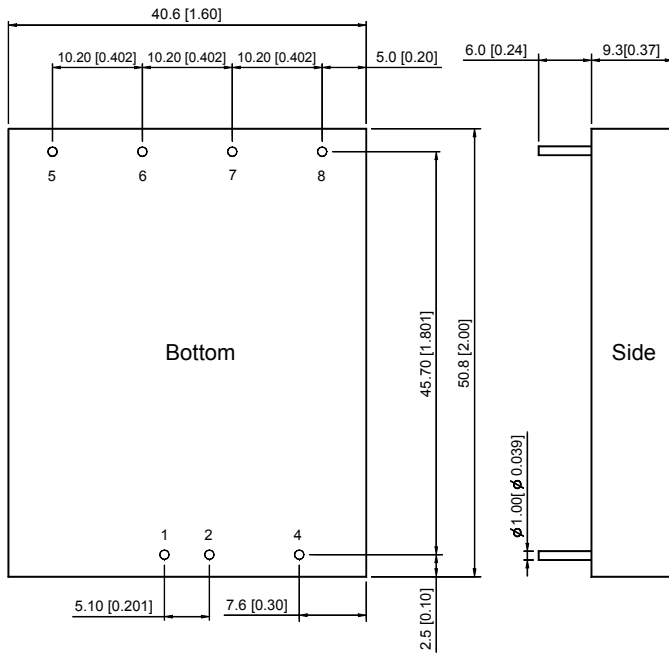

Tolerance	Millimeters	Inches
	X.X±0.25	X.XX±0.01
	X.XX±0.13	X.XXX±0.005
Pin	±0.05	±0.002

Connecting Pin Patterns

Bottom View (2.54 mm / 0.1 inch grids)

Single Output

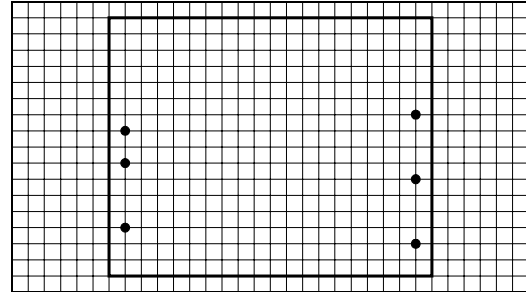

Dual Output

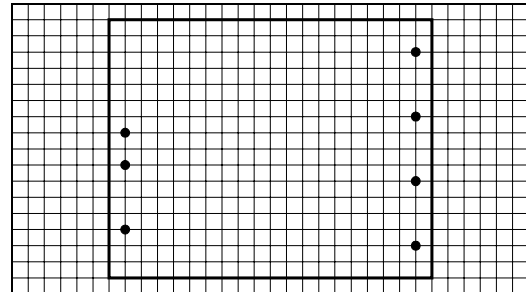

Pin Connections

Pin	Single Output	Dual Output
1	+Vin	+Vin
2	-Vin	-Vin
4	Remote On/Off	Remote On/Off
5	No Pin	+Vout
6	+Vout	Common
7	-Vout	-Vout
8	Trim	Trim

Physical Characteristics

Case Size	: 50.8×40.6×9.3 mm 2.0×1.6×0.37 inches
Case Material	: Metal With Non-Conductive Baseplate
Weight	: 48g
Flammability	: UL94V-0

The MPW1000 converter is encapsulated in a low thermal resistance molding compound that has excellent resistance/electrical characteristics over a wide temperature range or in high humidity environments. The encapsulant and unit case are both rated to UL 94V-0 flammability specifications. Leads are tin plated for improved solderability.