

IRG4BC40FPbF

INSULATED GATE BIPOLAR TRANSISTOR

Fast Speed IGBT

Features

- Fast: optimized for medium operating frequencies (1-5 kHz in hard switching, >20 kHz in resonant mode).
- Generation 4 IGBT design provides tighter parameter distribution and higher efficiency than Generation 3
- Industry standard TO-220AB package
- Lead-Free

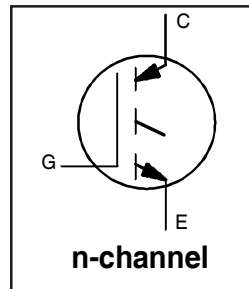

$V_{CES} = 600V$
$V_{CE(on) typ.} = 1.50V$
@ $V_{GE} = 15V, I_C = 27A$

Benefits

- Generation 4 IGBTs offer highest efficiency available
- IGBTs optimized for specified application conditions
- Designed to be a "drop-in" replacement for equivalent industry-standard Generation 3 IR IGBTs

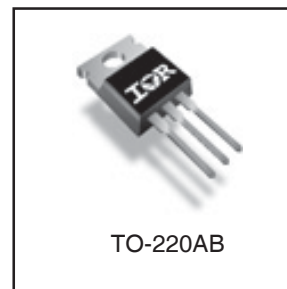

Absolute Maximum Ratings

	Parameter	Max.	Units
V_{CES}	Collector-to-Emitter Breakdown Voltage	600	V
$I_C @ T_C = 25^\circ C$	Continuous Collector Current	49	A
$I_C @ T_C = 100^\circ C$	Continuous Collector Current	27	
I_{CM}	Pulsed Collector Current ①	196	
I_{LM}	Clamped Inductive Load Current ②	196	
V_{GE}	Gate-to-Emitter Voltage	± 20	V
E_{ARV}	Reverse Voltage Avalanche Energy ③	15	mJ
$P_D @ T_C = 25^\circ C$	Maximum Power Dissipation	160	W
$P_D @ T_C = 100^\circ C$	Maximum Power Dissipation	65	
T_J T_{STG}	Operating Junction and Storage Temperature Range	-55 to + 150	°C
	Soldering Temperature, for 10 seconds	300 (0.063 in. (1.6mm from case)	
	Mounting torque, 6-32 or M3 screw.	10 lbf•in (1.1N•m)	

Thermal Resistance

	Parameter	Typ.	Max.	Units
$R_{\theta JC}$	Junction-to-Case	---	0.77	°C/W
$R_{\theta CS}$	Case-to-Sink, Flat, Greased Surface	0.50	---	
$R_{\theta JA}$	Junction-to-Ambient, typical socket mount	---	80	
Wt	Weight	2.0 (0.07)	---	g (oz)

Electrical Characteristics @ $T_J = 25^\circ\text{C}$ (unless otherwise specified)

	Parameter	Min.	Typ.	Max.	Units	Conditions
$V_{(BR)CES}$	Collector-to-Emitter Breakdown Voltage	600	—	—	V	$V_{GE} = 0V, I_C = 250\mu A$
$V_{(BR)ECS}$	Emitter-to-Collector Breakdown Voltage ④	18	—	—	V	$V_{GE} = 0V, I_C = 1.0A$
$\Delta V_{(BR)CES}/\Delta T_J$	Temperature Coeff. of Breakdown Voltage	—	0.70	—	V/°C	$V_{GE} = 0V, I_C = 1.0mA$
$V_{CE(ON)}$	Collector-to-Emitter Saturation Voltage	—	1.50	1.7	V	$I_C = 27A$ $V_{GE} = 15V$ See Fig.2, 5
		—	1.85	—		
		—	1.56	—		
$V_{GE(th)}$	Gate Threshold Voltage	3.0	—	6.0		$V_{CE} = V_{GE}, I_C = 250\mu A$
$\Delta V_{GE(th)}/\Delta T_J$	Temperature Coeff. of Threshold Voltage	—	-12	—	mV/°C	$V_{CE} = V_{GE}, I_C = 250\mu A$
g_{fe}	Forward Transconductance ⑤	9.2	12	—	S	$V_{CE} = 100V, I_C = 27A$
I_{CES}	Zero Gate Voltage Collector Current	—	—	250	μA	$V_{GE} = 0V, V_{CE} = 600V$
		—	—	2.0		$V_{GE} = 0V, V_{CE} = 10V, T_J = 25^\circ\text{C}$
		—	—	1000		$V_{GE} = 0V, V_{CE} = 600V, T_J = 150^\circ\text{C}$
I_{GES}	Gate-to-Emitter Leakage Current	—	—	± 100	nA	$V_{GE} = \pm 20V$

Switching Characteristics @ $T_J = 25^\circ\text{C}$ (unless otherwise specified)

	Parameter	Min.	Typ.	Max.	Units	Conditions
Q_g	Total Gate Charge (turn-on)	—	100	150	nC	$I_C = 27A$ $V_{CC} = 400V$ $V_{GE} = 15V$ See Fig. 8
Q_{ge}	Gate - Emitter Charge (turn-on)	—	15	23		
Q_{gc}	Gate - Collector Charge (turn-on)	—	35	53		
$t_{d(on)}$	Turn-On Delay Time	—	26	—	ns	$T_J = 25^\circ\text{C}$ $I_C = 27A, V_{CC} = 480V$ $V_{GE} = 15V, R_G = 10\Omega$ Energy losses include "tail" See Fig. 10, 11, 13, 14
t_r	Rise Time	—	18	—		
$t_{d(off)}$	Turn-Off Delay Time	—	240	360		
t_f	Fall Time	—	170	250		
E_{on}	Turn-On Switching Loss	—	0.37	—	mJ	See Fig. 10, 11, 13, 14
E_{off}	Turn-Off Switching Loss	—	1.81	—		
E_{ts}	Total Switching Loss	—	2.18	2.8		
$t_{d(on)}$	Turn-On Delay Time	—	25	—	ns	$T_J = 150^\circ\text{C}$, $I_C = 27A, V_{CC} = 480V$ $V_{GE} = 15V, R_G = 10\Omega$ Energy losses include "tail" See Fig. 13, 14
t_r	Rise Time	—	21	—		
$t_{d(off)}$	Turn-Off Delay Time	—	380	—		
t_f	Fall Time	—	310	—		
E_{ts}	Total Switching Loss	—	3.9	—	mJ	
L_E	Internal Emitter Inductance	—	7.5	—	nH	Measured 5mm from package
C_{ies}	Input Capacitance	—	2200	—	pF	$V_{GE} = 0V$ $V_{CC} = 30V$ $f = 1.0MHz$ See Fig. 7
C_{oes}	Output Capacitance	—	140	—		
C_{res}	Reverse Transfer Capacitance	—	29	—		

Notes:

- ① Repetitive rating; $V_{GE} = 20V$, pulse width limited by max. junction temperature. (See fig. 13b)
- ② $V_{CC} = 80\%(V_{CES}), V_{GE} = 20V, L = 10\mu H, R_G = 10\Omega$, (See fig. 13a)
- ③ Repetitive rating; pulse width limited by maximum junction temperature.
- ④ Pulse width $\leq 80\mu s$; duty factor $\leq 0.1\%$.
- ⑤ Pulse width $5.0\mu s$, single shot.

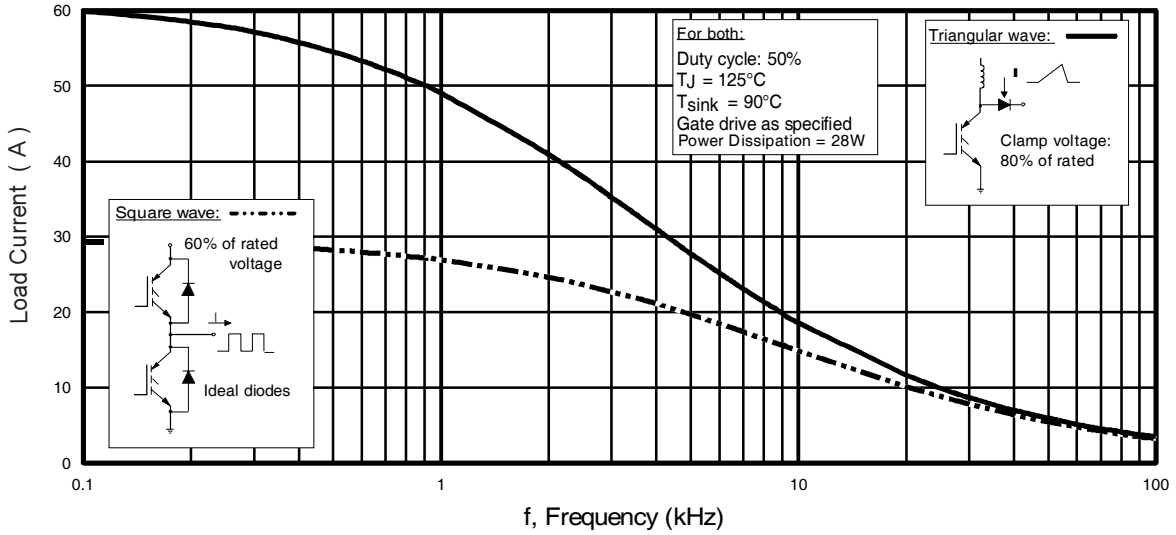

Fig. 1 - Typical Load Current vs. Frequency
(For square wave, $I = I_{RMS}$ of fundamental; for triangular wave, $I = I_{PK}$)

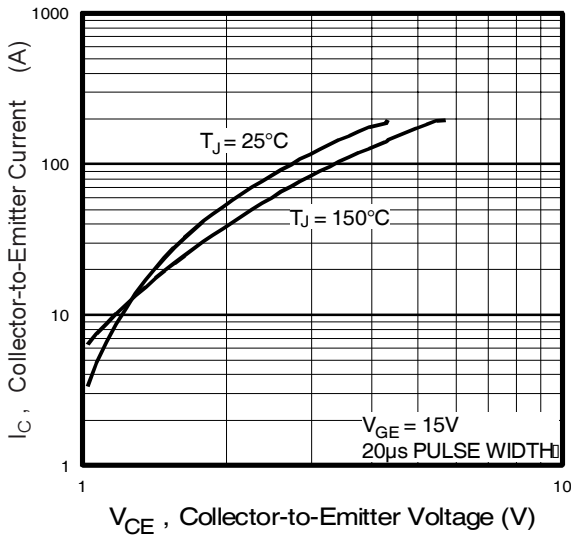

Fig. 2 - Typical Output Characteristics

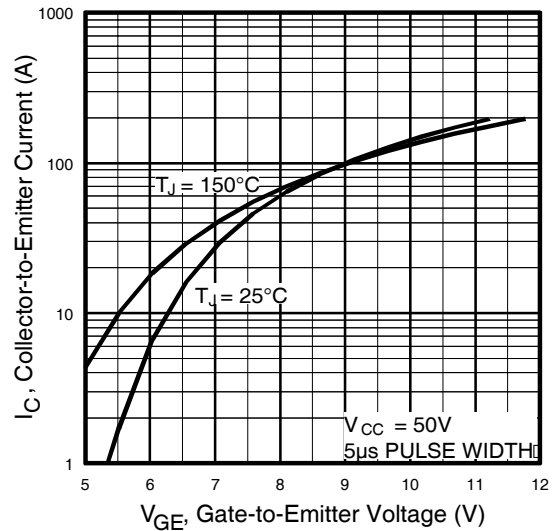

Fig. 3 - Typical Transfer Characteristics

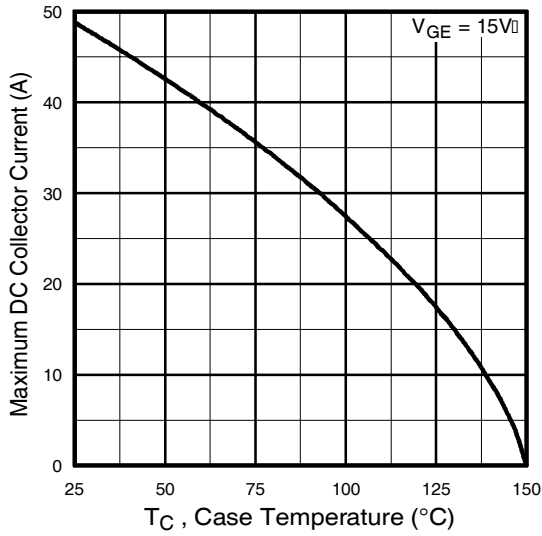

Fig. 4 - Maximum Collector Current vs. Case Temperature

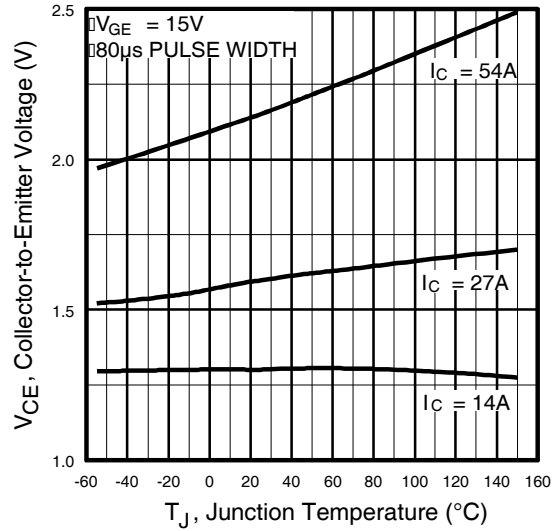

Fig. 5 - Typical Collector-to-Emitter Voltage vs. Junction Temperature

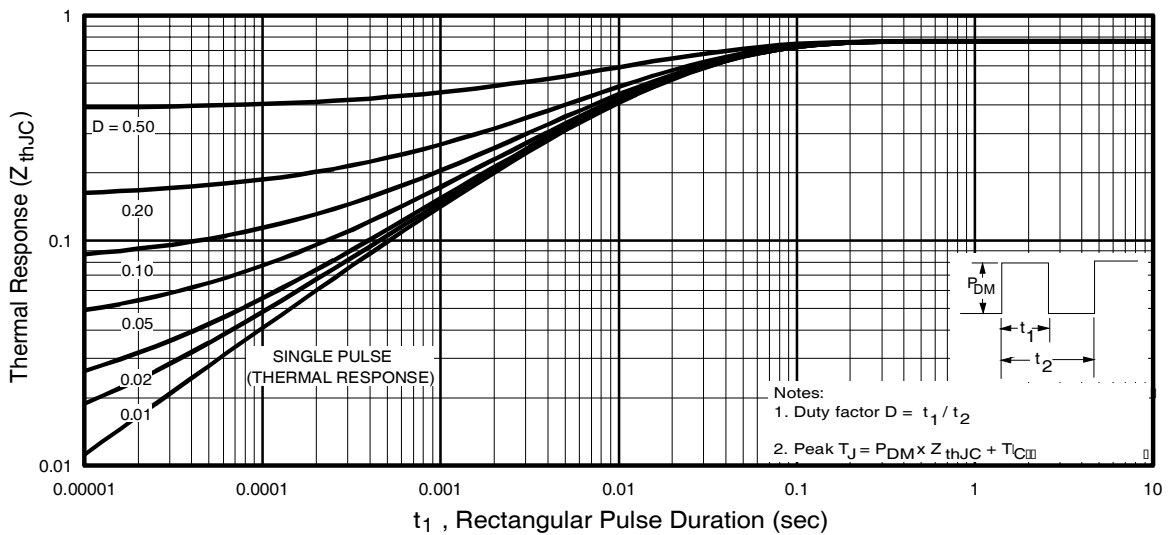

Fig. 6 - Maximum Effective Transient Thermal Impedance, Junction-to-Case

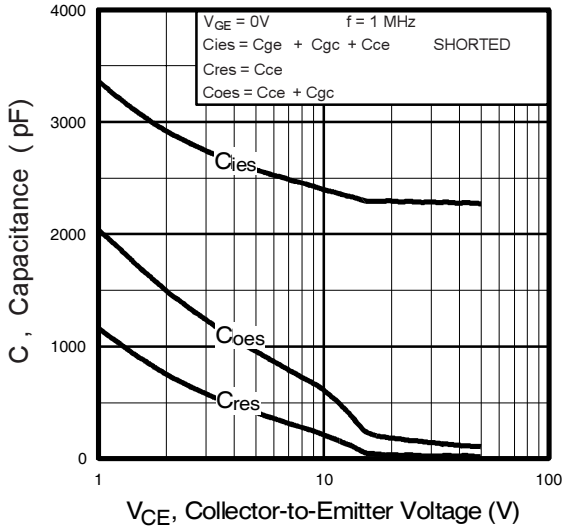

Fig. 7 - Typical Capacitance vs. Collector-to-Emitter Voltage

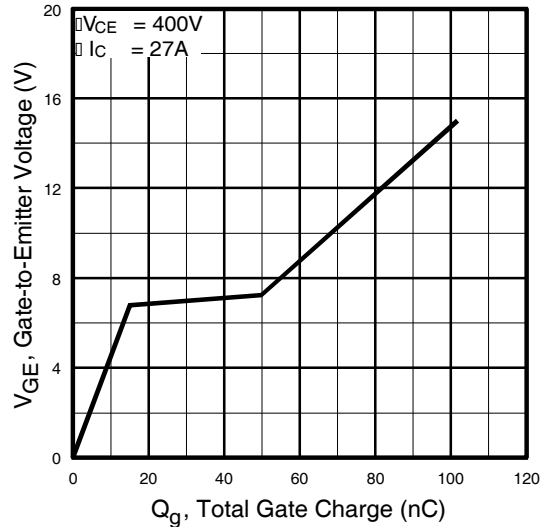

Fig. 8 - Typical Gate Charge vs. Gate-to-Emitter Voltage

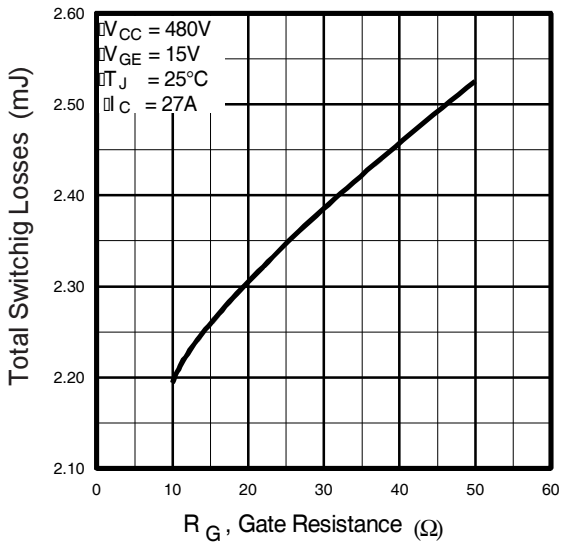

Fig. 9 - Typical Switching Losses vs. Gate Resistance

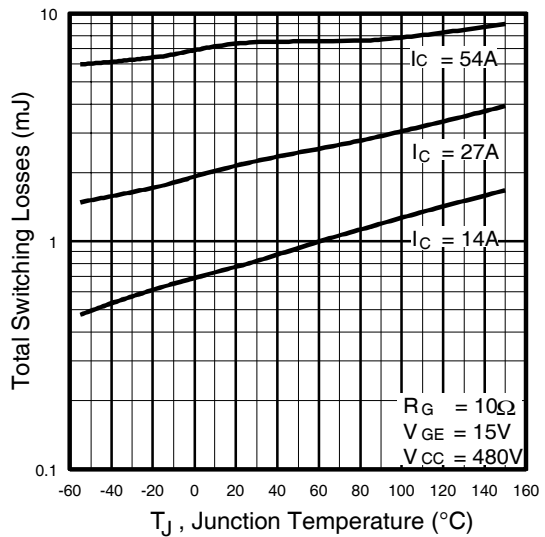

Fig. 10 - Typical Switching Losses vs. Junction Temperature

IRG4BC40FPbF

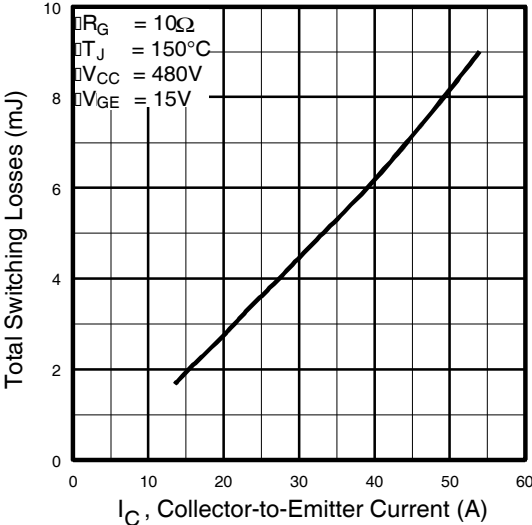

Fig. 11 - Typical Switching Losses vs. Collector-to-Emitter Current

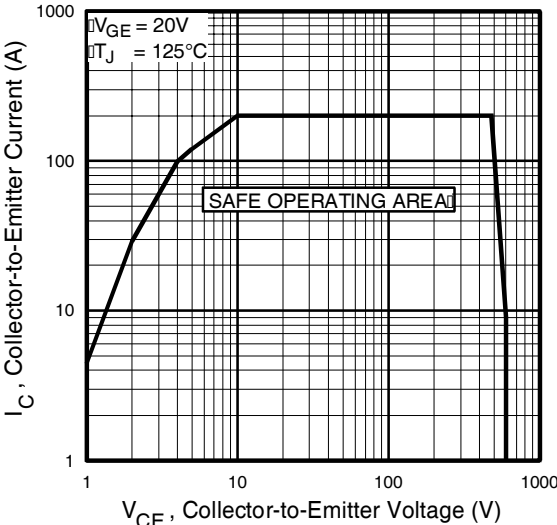
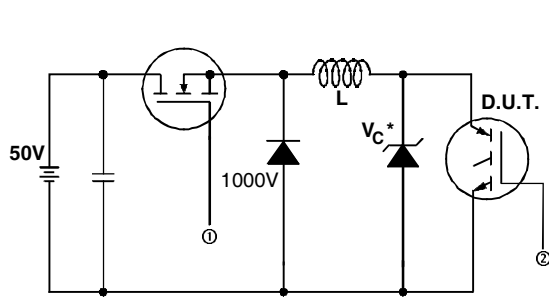

Fig. 12 - Turn-Off SOA

IRG4BC40FPbF



* Driver same type as D.U.T.; $V_c = 80\%$ of $V_{ce(max)}$
 * Note: Due to the 50V power supply, pulse width and inductor will increase to obtain rated I_d .

Fig. 13a - Clamped Inductive Load Test Circuit

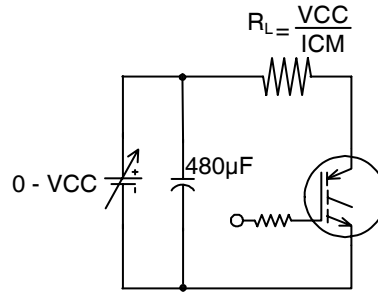

Fig. 13b - Pulsed Collector Current Test Circuit

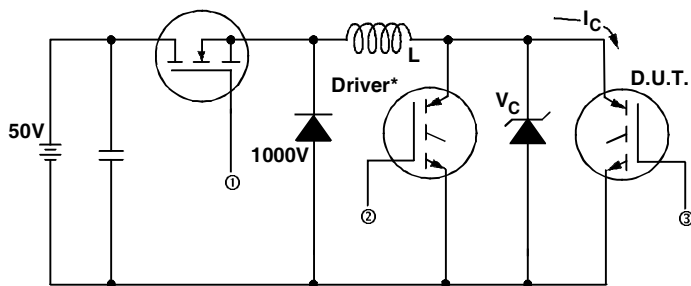

Fig. 14a - Switching Loss Test Circuit

* Driver same type as D.U.T., $V_C = 480V$

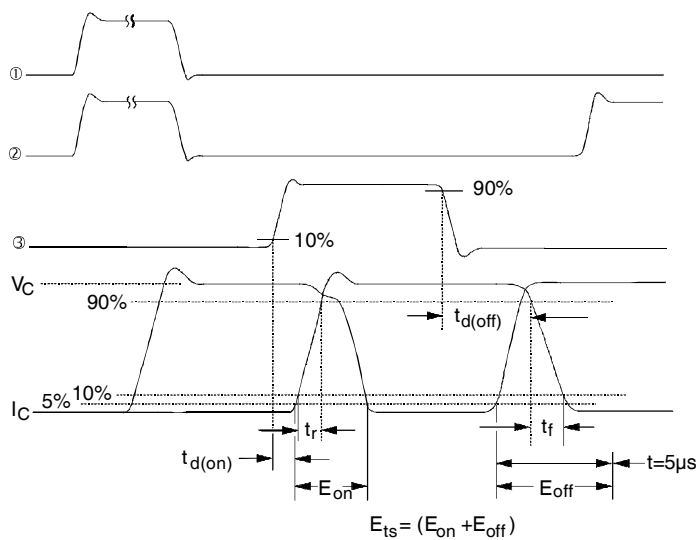
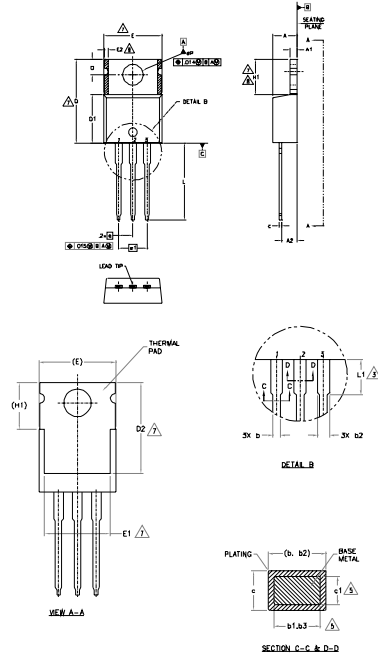

Fig. 14b - Switching Loss Waveforms

IRG4BC40FPbF

International
IR Rectifier

TO-220AB Package Outline (Dimensions are shown in millimeters (inches))



- NOTES:
- 1.- DIMENSIONING AND TOLERANCING AS PER ASME Y14.5 M- 1994.
 - 2.- DIMENSIONS ARE SHOWN IN INCHES (MILLIMETERS).
 - 3.- LEAD DIMENSION AND FINISH UNCONTROLLED IN (1).
 - 4.- DIMENSION D, D1 & E DO NOT INCLUDE MOLD FLASH. MOLD FLASH SHALL NOT EXCEED .005" (0.127) PER SIDE. THESE DIMENSIONS ARE MEASURED AT THE OUTERMOST EXTREMES OF THE PLASTIC BODY.
 - 5.- DIMENSION D1, D2 & c1 APPLY TO BASE METAL ONLY.
 - 6.- CONTROLLING DIMENSION - INCHES.
 - 7.- THERMAL PAD CONTOUR OPTIONAL. MINIMUM DIMENSIONS E1, D2 & E1.
 - 8.- DIMENSION E2 & H1 DEFINE A ZONE WHERE STAMPING AND SINGULATION IRREGULARITIES ARE ALLOWED.
 - 9.- OUTLINE CONFORMS TO JEDEC TO-220, EXCEPT A2 (max.) AND D2 (min.) THESE DIMENSIONS ARE DERIVED FROM THE ACTUAL PACKAGE OUTLINE.

SYMBOL	DIMENSIONS				NOTES
	MILLIMETERS		INCHES		
	MIN.	MAX.	MIN.	MAX.	
A	3.56	4.83	.140	.190	
A1	0.51	1.40	.020	.055	
A2	2.03	2.92	.080	.115	
b	0.38	1.01	.015	.040	
b1	0.38	0.97	.015	.038	5
b2	1.14	1.78	.045	.070	
b3	1.14	1.73	.045	.068	5
c	0.36	0.61	.014	.024	
c1	0.36	0.56	.014	.022	5
D	14.22	16.51	.560	.650	4
D1	8.38	9.02	.330	.355	
D2	11.68	12.88	.460	.507	7
E	9.65	10.67	.380	.420	4,7
E1	6.86	8.89	.270	.350	7
E2	-	0.76	-	.030	8
e	2.54 BSC		.100 BSC		
e1	3.06 BSC		.120 BSC		
H1	5.84	6.86	.230	.270	7,8
L	12.70	14.73	.500	.580	
L1	3.56	4.06	.140	.160	3
ØP	3.54	4.08	.139	.161	
Ø	2.54	3.42	.100	.135	

USER ASSEMBLY

- 1- GATE
- 2- ANODE
- 3- CATHODE

MINI-STRAP

- 1- GATE
- 2- CATHODE
- 3- ANODE

MARKS

- 1- ANODE
- 2- CATHODE
- 3- GATE

TO-220AB Part Marking Information

EXAMPLE: THIS IS AN IRF1010
 LOT CODE 1789
 ASSEMBLED ON WW 19, 1997
 IN THE ASSEMBLY LINE 'C'
Note: "P" in assembly line position indicates "Lead-Free"

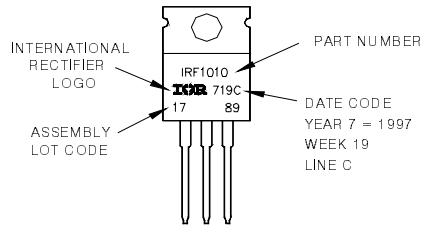

Note: For the most current drawing please refer to IR website at <http://www.irf.com/package/>

Data and specifications subject to change without notice.

International
IR Rectifier

IR WORLD HEADQUARTERS: 233 Kansas St., El Segundo, California 90245, USA Tel: (310) 252-7105

TAC Fax: (310) 252-7903

Visit us at www.irf.com for sales contact information.02/2010