

△ Recommended P.C.B. Layout

SPECIFICATION

Current Rating:5A AC/DC
 Voltage Rating:250V AC Max.
 Operating Temperature:-25°C~+85°C
 Insulation Resistance:1000 Megaohms Min.
 Contact Resistance:10 Milliohms Max.
 △ Insulator:PA66(UL94V-0)
 △ Terminal:Brass,Tin Plated Over Nickel
 RoHS Compliant

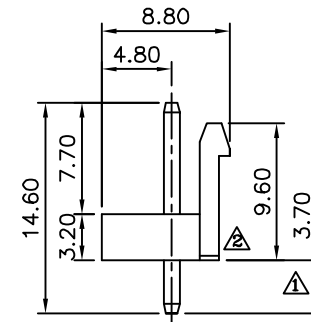
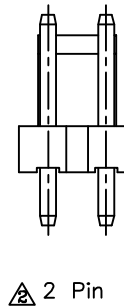
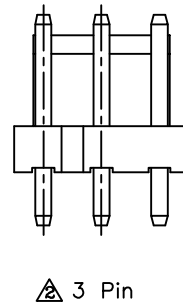
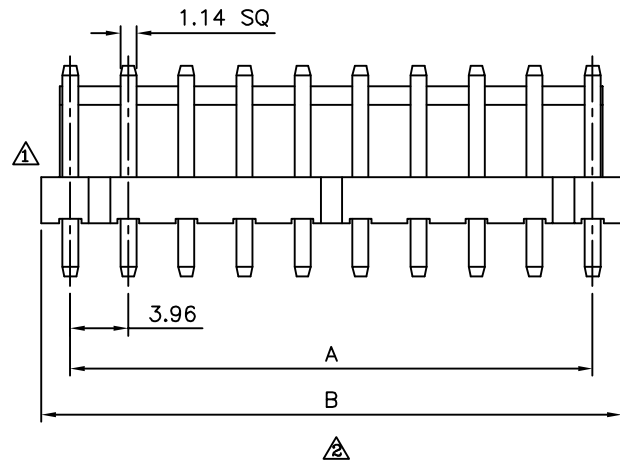
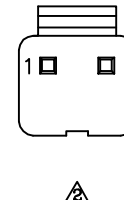
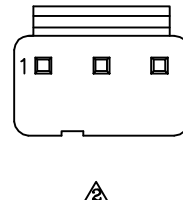
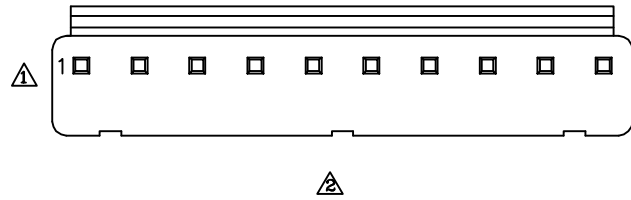

Pin	A	B
02	3.96	7.92
03	7.92	11.92
04	11.88	15.84
05	15.84	19.84
06	19.80	23.80
07	23.76	27.88
08	27.72	31.74
09	31.68	35.86
10	35.64	39.90
11	39.60	43.84
12	43.56	47.92
13	47.52	51.72
14	51.48	55.92



DRAWING No.
02198

APPROVED BY
MEI
 CHECKED BY
HZF
 DRAWING BY
SONG

UNLESS OTHERWISE SPECIFIED TOLERANCES ARE
 .X ±0.5
 .XX ±0.35
 ANG.

SCALE NONE REV. B2 UNIT mm

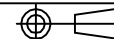

NO.	REV.	REVISIONS	CHK	DATE
△ B2		Modify Data	HZF	01/03/2013
△ B1		Modify Data	HZF	09/15/2009
△ B0		NEW RELEASE	BECKY	11/14/2005