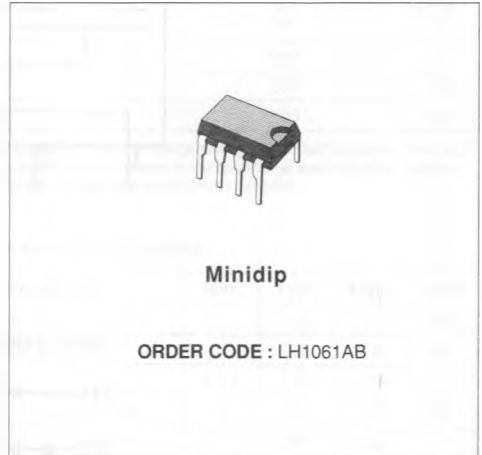

DOUBLE POLE HIGH-VOLTAGE SOLID-STATE RELAY

ADVANCE DATA

AN AT & T PRODUCT

- HIGH VOLTAGE IC FABRICATED IN A DIELECTRIC ISOLATION PROCESS
- OPTICAL COUPLING BETWEEN INPUT AND OUTPUT
- CAN SWITCH TWO SEPARATE LOADS UP TO 200V EACH AT CURRENTS UP TO 200mA
- LOW ON-RESISTANCE
- CLEAN, BOUNCE-FREE SWITCHING
- HIGH CURRENT SURGE CAPABILITY
- LOW-POWER CONSUMPTION
- NO ELECTROMAGNETIC INTERFERENCE

DESCRIPTION

The LH1061 (Multipurpose Solid-State Relay) is a low-cost, bi-directional, SPDT designed to switch both AC and DC loads. Outputs are rated at 200V and can handle contemporarily two loads up to 200mA. It is packaged in a special 8-pin plastic DIP.

Each device consists of one GaAlAs LED to optically couple the control signal to two high-voltage integrated switches. The typical ON-Resistance is 15Ω at 25mA, and is exceptionally linear up to 100mA. Beyond 100mA, the incremental resistance becomes even less, thereby minimizing internal power dissipation. The LH1061 also has internal current limiting which clamps the load current at 300mA to insure that the device will survive during current surges.

PIN CONNECTION

Figure 1 : Functional and Equivalent Diagram.



PIN DESCRIPTION

Name	Description
Control + Control -	These pins are the positive and negative inputs respectively to the input control LED. An appropriate amount of current through the LED will close the circuit path between S and S'.
S1, S1' S2, S2'	These pins are the outputs. The pins designated as S represents one side of a relay pole. The pins designated as S' are the complementary side of a relay pole. Note that S2 is connected to the substrate.
NC	This pin is connected internally for test purposes. It should NOT be used as a tie-point for external components.
Blank	This pin may be used as a tie point for external components. Voltage applied to this pin should not exceed 150V.

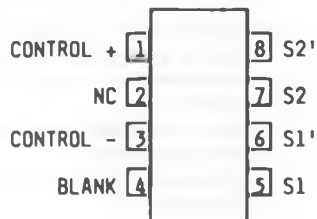
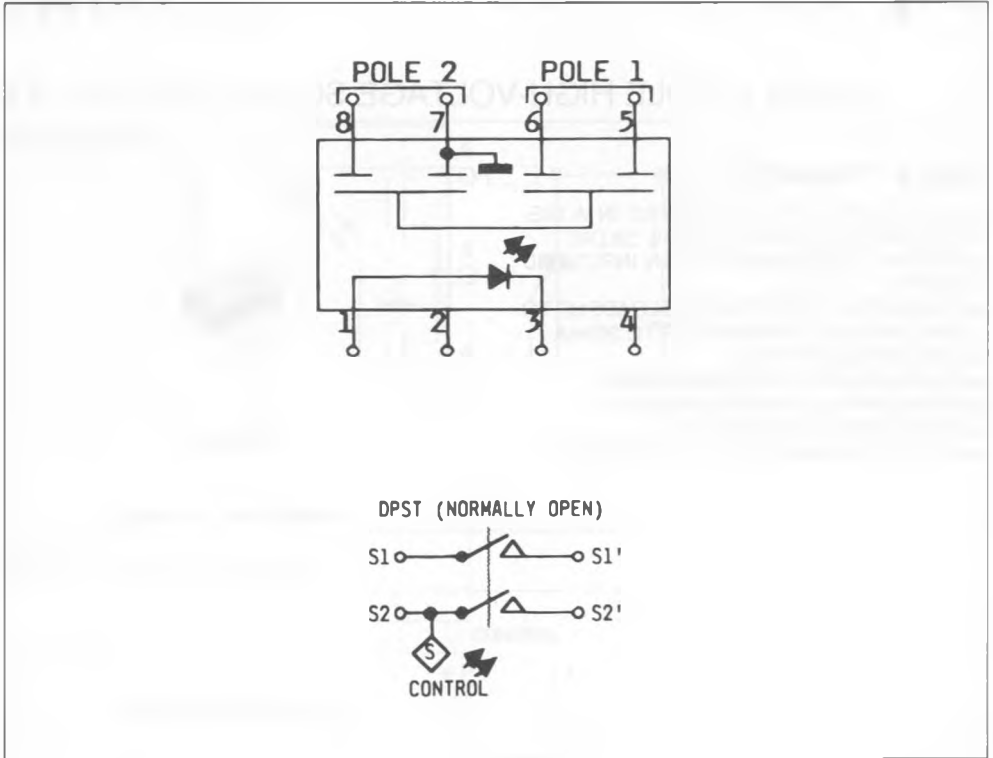
ABSOLUTE MAXIMUM RATINGS (at 25°C unless otherwise specified)

Parameter	Value	Unit
Ambient Operating Temperature Range	- 40 to + 85	°C
Storage Temperature Range	- 40 to + 100	°C
Pin Soldering Temperature (t = 15s max)	300	°C
LED INPUT :		
Continuous Forward Current	20	mA
Reverse Voltage	10	V
Operating Voltage	200	V
One Pole (S1, S1' or S2, S2')	300	mA
Each Pole (two poles operating simultaneously)	200	mA

Stresses in excess of those listed under "Absolute Maximum Ratings" may cause permanent damage to the device. This is a stress rating only and functional operation of the device at these or any other conditions in excess of those indicated in the operational sections of this specification is not implied. Exposure to absolute maximum rating conditions for extended periods may affect device reliability.

ELECTRICAL CHARACTERISTICS (at 25°C unless otherwise specified)

Parameter	Test Conditions	Min.	Typ.	Max.	Unit
LED Forward Current for Turn-on*	$I_{LOAD} = 200mA$		1.5	2.5	mA
	$I_{LOAD} = 160mA, 70^{\circ}C$		2.5	5.0	mA
LED ON Voltage @ 10mA	$I_{LED} = 10mA$	1.15	1.30	1.45	V
ON Resistance : $R_{ON} = V_M/50mA$	$I_{LED} = 2.5mA ; I_{LOAD} = 50mA$	8	12	15	Ω
ON Voltage	$I_{LED} = 2.5mA ; I_{LOAD} = 200mA$		2.0	2.5	V
Output Off-state Leakage Current	100V, $I_{LED} = 0\mu A$		1.0		nA
	100V, $I_{LED} = 200\mu A$		0.1	2.0	μA
Breakdown Voltage @ 50 μA (figure 2)	$I_{LED} = 0\mu A ; I_{LOAD} = 50\mu A$	200	230		V
Turn-on Time	$R_L = 15k\Omega$ $I_{LED} = 5mA$		2.0		ms
Turn-off Time			1.0		
Feedthrough Capacitance, Pin 4 to 6 (4V _{pp} , 1kHz)			35		pF
Pole to pole Capacitance (4V _{pp} , 1kHz)			20		pF

* Supply a minimum of 6mA LED current to insure proper operation over the full operating temperature range

TEST CIRCUITS

Figure 2 : R_{ON} , ON Voltage and Breakdown Voltage.

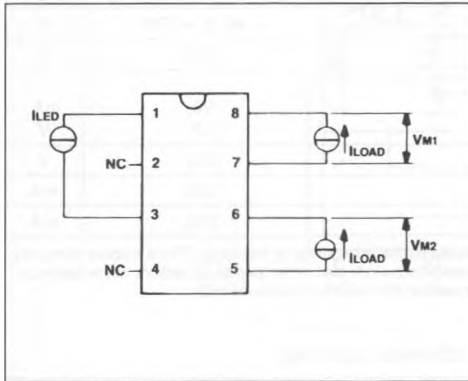

Figure 3 : Leakage Current.

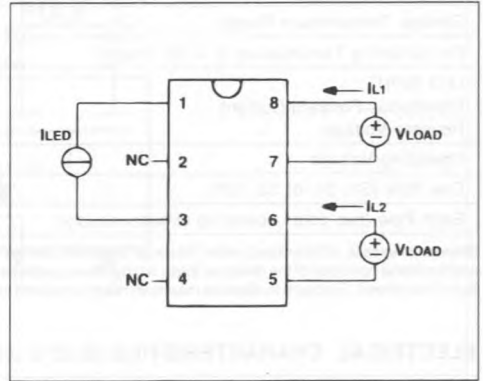
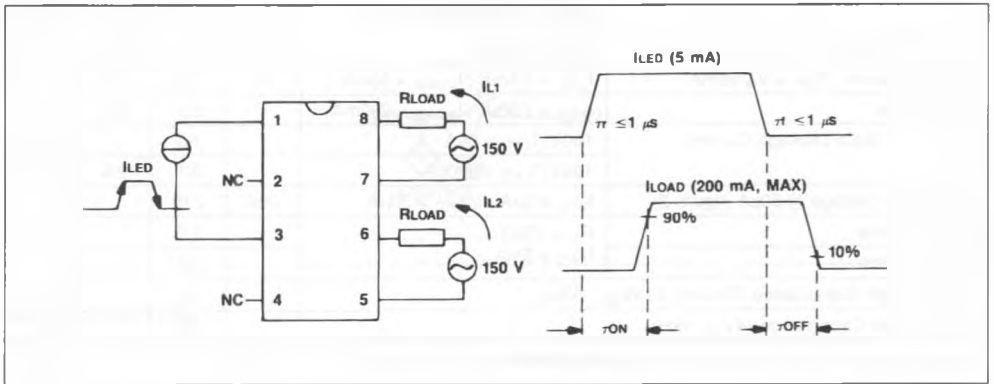

Figure 4 : τ_{ON}/τ_{OFF} Test Circuit and Waveform.



CHARACTERISTICS CURVES

Figure 5 : Solid-state Relay Typical ON Characteristics.

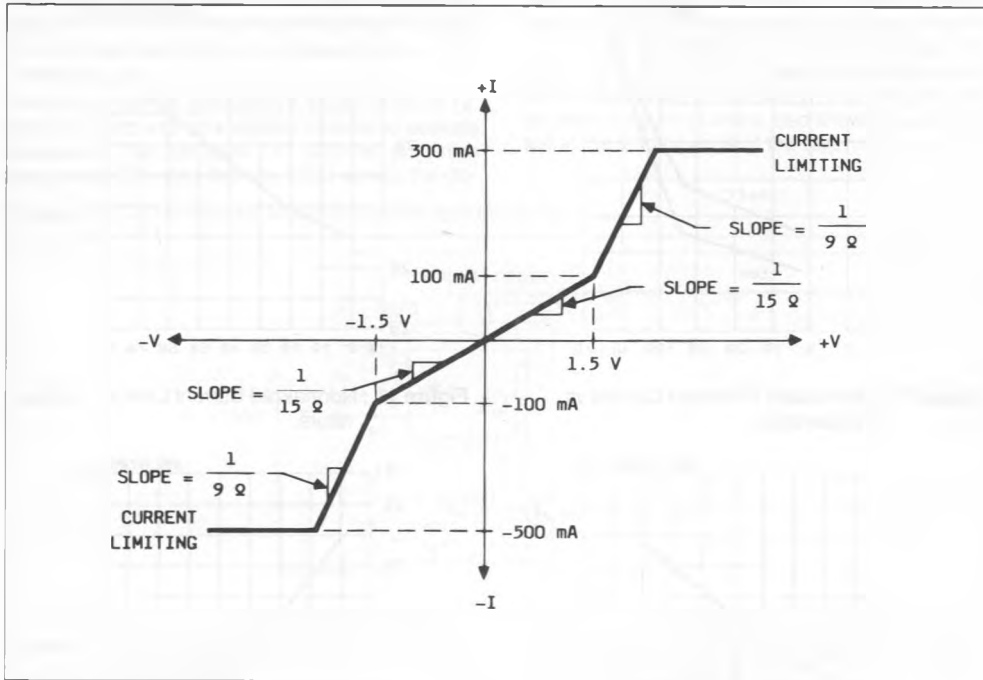

Figure 6 : Normalized Turn-on Time vs. Temperature.

Figure 7 : Normalized Turn-off Time vs. Temperature.

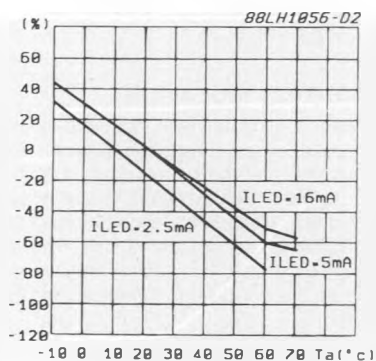
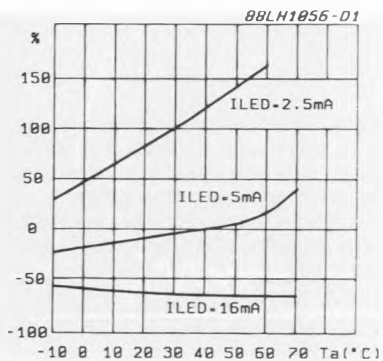

Figure 8 : Normalized Switching Time vs. Load Voltage.

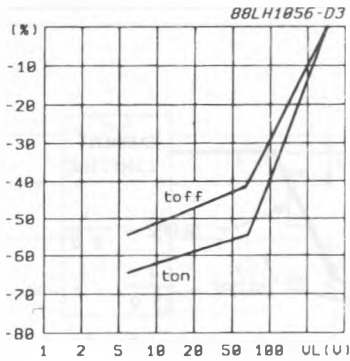

Figure 9 : Normalized On-resistance vs. Temperature.

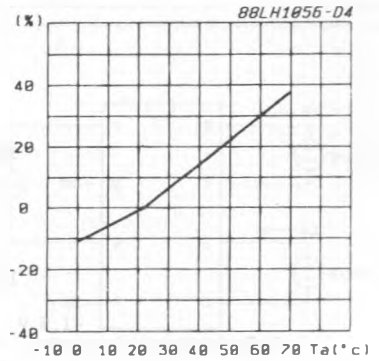

Figure 10 : Normalized Threshold Current vs. Temperature.

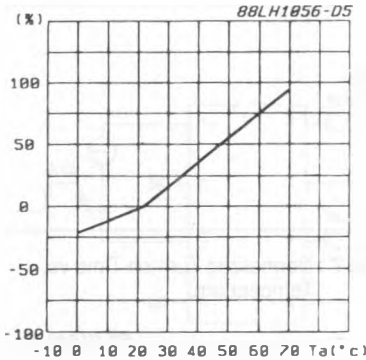
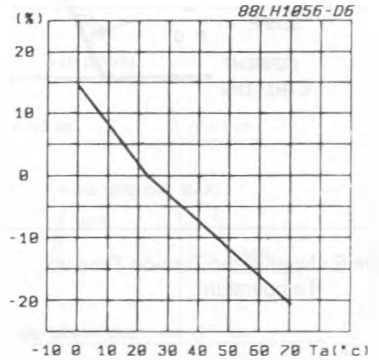

Figure 11 : Normalized Current Limit vs. Temperature.



INPUT/OUTPUT ISOLATION

The optical coupling between input and output provides a great degree of isolation between the low-voltage control and the high-voltage output. Each device meets the 1500Vrms U/L (Underwriters Laboratories) test, which requires the product to withstand 1500Vrms for a time of one minute. For throughput purposes, U/L allows reduction of the test time to 1 second if the stress is increased to 1800Vrms.

In order to further assure long term reliability, each device is tested with an additional 600Vrms of guardband, bringing the total test stress to 2400Vrms for one second. During the test, less than 100nA of leakage is required. After passing this test, the part is subjected to the parameters specified by the data sheet.

LOAD PROTECTION

The LH1061 has been designed to protect the switched load by quick transient suppression and by output current limitation. These features can be illustrated by evaluation of the step response of the closed contact.

The circuit used for evaluation is shown in figure 12. First, a control signal is applied in order to activate the switch. Then transistor TR1 is turned on, which activates a 50V step through 100Ω across the clo-

sed switch. The switch reacts to the leading edge of the step by quickly deactivating, stopping current flow in the load. The resultant load current is shown in figure 13. After 250μs, the switch recloses, allowing current to flow in the load, up to the current limit of the device, if necessary. This clamping can be seen in figure 14 which also shows the fast shut-off at the leading edge of the step.

Figure 12 : Circuit used for Measurements of figures 13, 14.

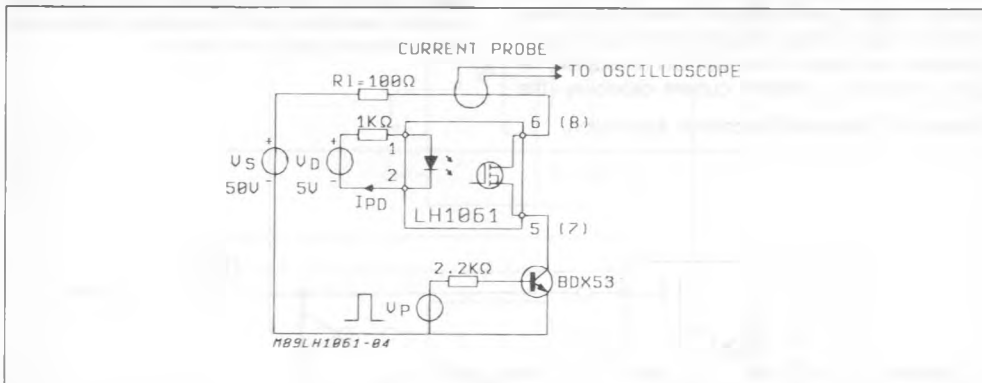

Figure 13 : Current spike ($R_L = 100\Omega$, $V_s = 50V$).
 X = 0.5μs/div.
 Y = 60mA/div.
 Upper Trace : load current.
 Lower Trace : command pulse.

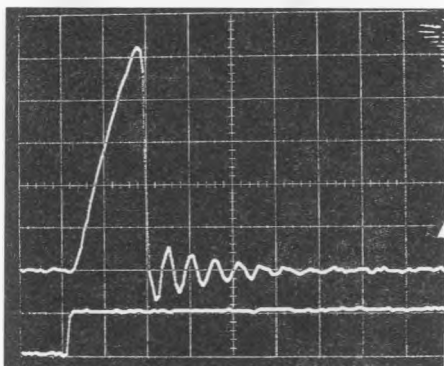
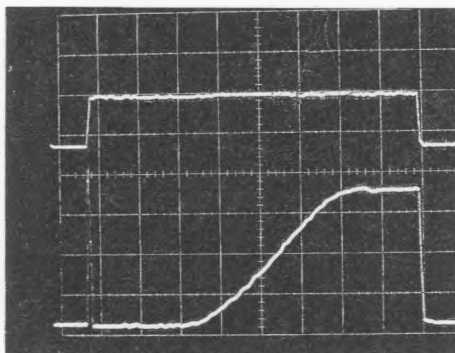

Figure 14 : Current limiting ($V_s = 50V$, $R_L = 100\Omega$).
 X = 0.2ms/div.
 Y = 80mA/div.
 Upper Trace : command pulse.
 Lower Trace : load current.



APPLICATION

This device has been optimized to meet the demands of switching high voltages at moderate current levels in applications such as telecommunications, instrumentation, and medium-power switching. It is ideally suited for applications where high performance, noise-free switching of ac and dc signals is desirable.

The operational range of this device includes low-power commercial voltage applications where millampere control signals and low ON-resistance are required. The speed, reliability, and linearity of this switch makes it well suited for those applications which are beyond the range of mechanical relays, thyristors, and triacs. For lower ON resistance, higher voltages, or greater current capability, the

LH1061 can be easily combined in parallel or series arrangements, as required, with their control LEDs simply driven in series.

The low ON-resistance and low-noise features are beneficial in instrumentation applications. The optical coupling provides isolation of the switch from the control signals in high-voltage and high-frequency applications.

The fabrication of high-voltage, monolithic ICs in a unique dielectric isolation process provides high reliability and the solid-state construction eliminates problems associated with mechanical relays such as sensitivity to shock and vibration.

Figure 15 : Balanced Switchhook Application.

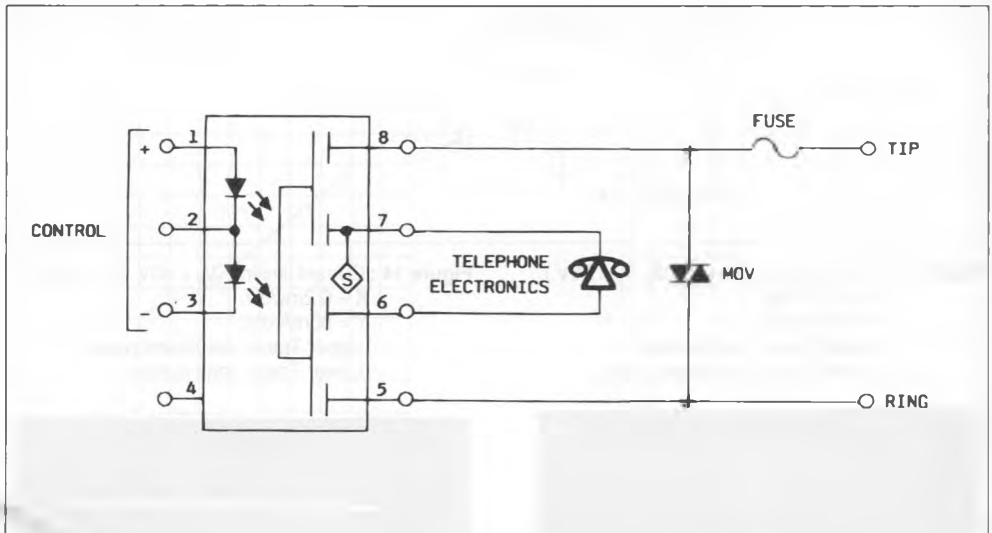

Figure 16 : Balanced Two-line Multiplexer Application.

