



Pyroelectric Infrared Radial Sensor

**TYPE: D204B
NANYANG SENBA OPTICAL AND ELECTRONIC CO., LTD.**

Anti-Jamming Dual Element Pyroelectric Infrared Radial Sensor

The pyroelectric infrared sensor detects infrared radiation on the basis of the characteristics that the polarization of pyroelectric material changes with temperature. Dual compensated sensing elements are applied to suppress the interference resulting from temperature variation with the EMI components. As a result, the operating stability of the sensor is greatly improved. Our products can be used world wide for many applications. Such as in security systems, burglar alarms, visitor acknowledgement, light switch control and intellectualized toy, etc.

Standard Specifications and Dimensions

Recommended Model	D204B big window
Encapsulation Type	TO-5
IR Receiving Electrode	2*1mm, 2 elements
Window Size	5*3.8mm
Spectral Response	5—14 μ m
Transmittance	$\geq 75\%$
Output Signal[Vp-p]	$\geq 3500\text{mV}$
Sensitivity	$\geq 3300\text{V/W}$
Detectivity (D^*)	$1.4 \times 10^8 \text{ cmHz}^{1/2}/\text{W}$
Noise[Vp-p]	$< 70\text{mV}$
Output Balance	$< 10\%$
Offset Voltage	0.3~1.2V
Supply Voltage	3—15V
Operating Temp	-30—70 $^{\circ}\text{C}$
Storage Temp	-40—80 $^{\circ}\text{C}$
Field of View	
Equivalent Circuit	

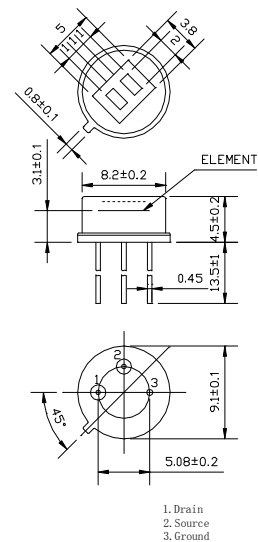

■ Test Method

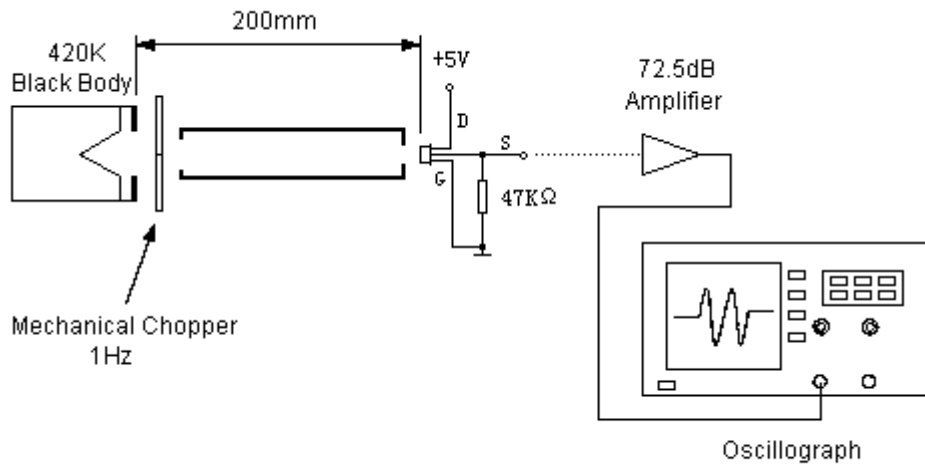

Measurement conditions

- ◆ Circumstance situation temperature 25°C
- ◆ Black-body temperature 420K (@147°C)
- ◆ Chopping frequency 1 Hz, 0.3~3.5Hz Δf ,
- ◆ 72.5 dB Amplifier

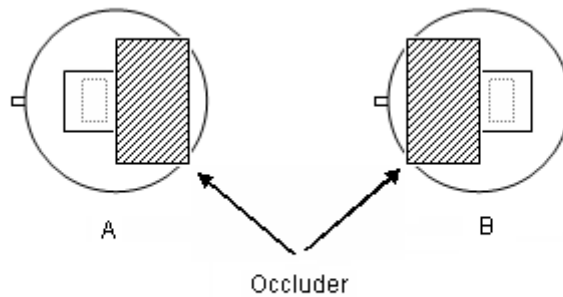

The sensitivity balance of dual elements sensor is calculated by measuring the sensitivity (signal output voltage) of each element and uses the formula as below:

$$\text{Balance} = \frac{|V_A - V_B|}{(V_A + V_B)} \times 100\%$$

V_A = Sensitivity of side A (mVp-p)

V_B = Sensitivity of side B (mVp-p)

■ Typical Application

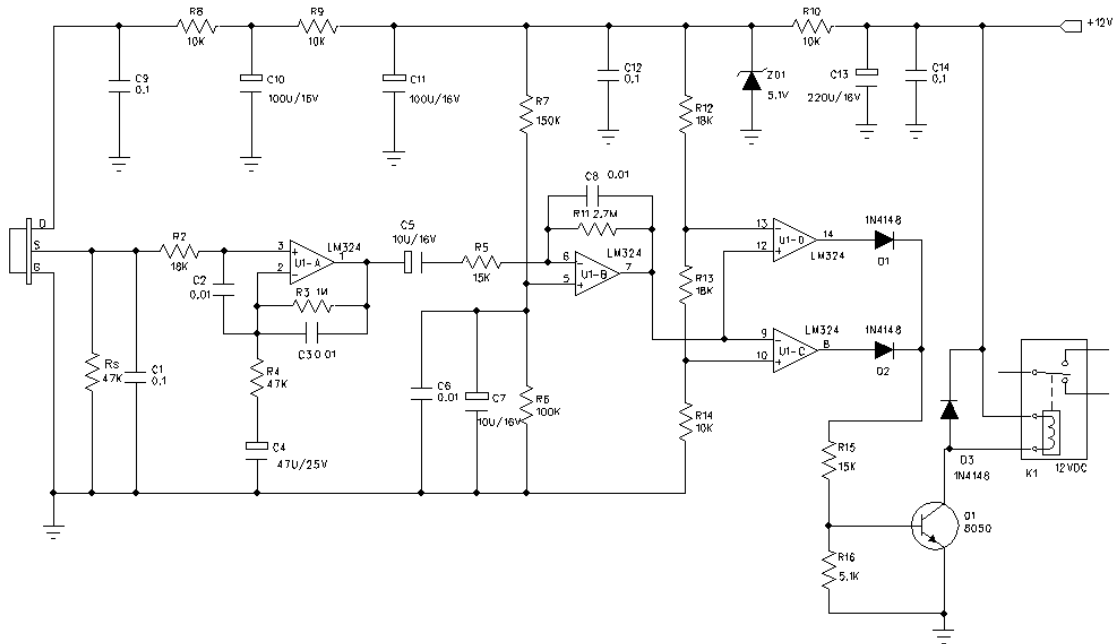

Notice:

U1A-D:LM324

Vdd:12V DC

Rs=47KΩ @ on an offset voltage

■ Spectral Response of Window Materials

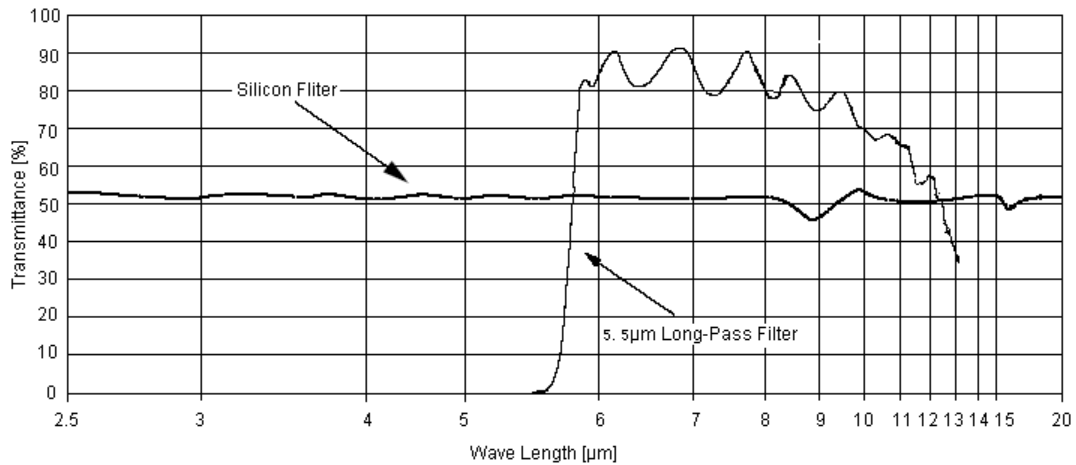

Notice:

The typical average transmittion curve of 5 µ m pass IR filter is figured, which is vacuumed on silicon filter.

■ Fresnel Lens for Human Body Detection

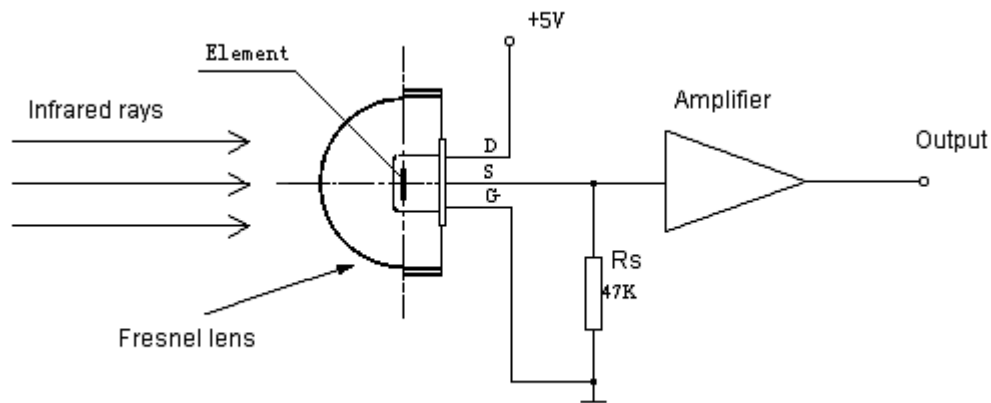
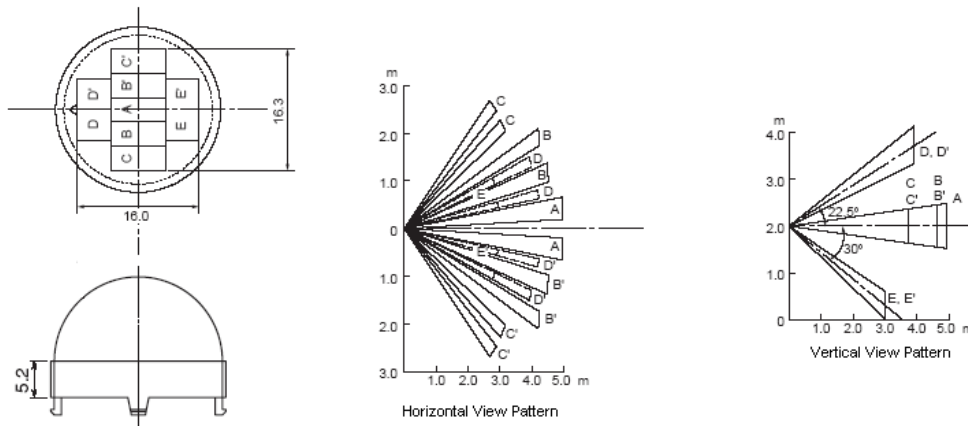

■ Directions for Use

- Pay attention to the mounting direction of the sensor's element and the parts size in the ichnography. You can get a optimal optical design according to the focus of the Fresnel Lens.
- The sensor parameter testing is operated in the condition of the standard Black Body and the interrelated circuit after one minute steadying-time.
- The sensor detecting distance is a multidimensional function, which consists of ambient temperature ,moving target temperature, Fresnel Lens' target distance , environment humidity , amplifier gain and comparison voltage.
- It is recommended that the welding length of the sensor's down-lead should not be less than 4mm ,and the soldering time is as short as possible.
- Do not touch the window by hand and the hard things.
- Strong shake and electrostatics should be avoided.
- This product is packed with the environmental protection material, and the sensor's surface have been covered specially with the OHK anticorit material. Small package have 100PCS, and big package 3000PCS.



SENBA OPTOELECTRONIC

NANYANG SENBA OPTICAL AND ELECTRONIC CO. LTD. SHENZHEN BRANCH

Add : 2nd Floor, No.4 Building, Huawan Industry Zone, Gushu, Xixiang Street ,
Bao'an Dist., ShenZhen City China

Website: www.nysenba.com

E-mail : sales@nysenba.com

Tel : 86-755-82594732, 82591709, 82591786, 82591705, 82591635

Fax : 86-755-82594762