

Digital Step Attenuator

50Ω DC-2400 MHz

31 dB, 1 dB Step

5 Bit, Parallel Control Interface, Single Positive Supply Voltage, +3V

Product Features

- Single positive supply voltage, +3V
- Immune to latch up
- Excellent accuracy, 0.1 dB Typ
- Parallel control interface
- Low Insertion Loss
- High IP3, +52 dBm Typ
- Very low DC power consumption
- Excellent return loss, 20 dB Typ
- Small size 4.0 x 4.0 mm

Typical Applications

- Base Station Infrastructure
- Portable Wireless
- CATV & DBS
- MMDS & Wireless LAN
- Wireless Local Loop
- UNII & Hiper LAN
- Power amplifier distortion canceling loops

General Description

The DAT-31-PP is a 50Ω RF digital step attenuator that offers an attenuation range up to 31 dB in 1.0 dB steps. The control is a 5-bit parallel interface, operating on a single +3 volt supply. The DAT-31-PP is produced using a unique CMOS process on silicon, offering the performance of GaAs, with the advantages of conventional CMOS devices.



DAT-31-PP+
DAT-31-PP

+ RoHS compliant in accordance with EU Directive (2002/95/EC)

The +suffix identifies RoHS Compliance. See our web site for RoHS Compliance methodologies and qualifications.

Simplified Schematic

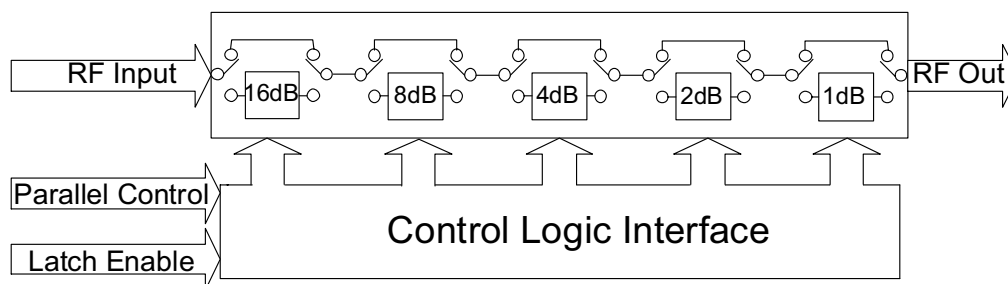

Distribution Centers NORTH AMERICA 800-654-7949 • 417-335-5935 • Fax 417-335-5945 • EUROPE 44-1252-832600 • Fax 44-1252-837010

Mini-Circuits ISO 9001 & ISO 14001 Certified

INTERNET <http://www.minicircuits.com>



Rev. B
M106151
DAT-31-PP
061121
Page 1 of 12

RF Electrical Specifications, DC-2400 MHz, $T_{AMB}=25^{\circ}C$, $V_{DD}=+3V$

Parameter	Freq. Range (GHz)	Min.	Typ.	Max.	Units
Accuracy @ 1 dB Attenuation Setting	DC-1	—	0.02	0.1	dB
	1-2.4	—	0.05	0.15	dB
Accuracy @ 2 dB Attenuation Setting	DC-1	—	0.05	0.15	dB
	1-2.4	—	0.15	0.25	dB
Accuracy @ 4 dB Attenuation Setting	DC-1	—	0.07	0.2	dB
	1-2.4	—	0.15	0.25	dB
Accuracy @ 8 dB Attenuation Setting	DC-1	—	0.03	0.2	dB
	1-2.4	—	0.15	0.25	dB
Accuracy @ 16 dB Attenuation Setting	DC-1	—	0.1	0.3	dB
	1-2.4	—	0.15	0.3	dB
Insertion Loss ^(note1) @ all attenuator set to 0dB	DC-1	—	1.3	1.9	dB
	1-2.4	—	1.6	2.4	dB
Input IP3 ^(note2) (at Min. and Max. Attenuation)	DC-2.4	—	+52	—	dBm
Input Power @ 0.2dB Compression ^(note 2) (at Min. and Max. Attenuation)	DC-2.4	—	+24	—	dBm
VSWR	DC-1	—	1.2	1.5	—
	1-2.4	—	1.2	1.5	—

Notes:

1. Loss values are de-embedded from test board Loss (test board's Insertion Loss: 0.10dB @100MHz, 0.35dB @1000MHz, 0.60dB @2400MHz, 0.75dB @4000MHz)
2. Input IP3 and 1dB compression degrades below 1 MHz

DC Electrical Specifications

Parameter	Min.	Typ.	Max.	Units
V_{DD} , Supply Voltage	2.7	3	3.3	V
I_{DD} , Supply Current	—	—	100	μA
Control Input Low	—	—	$0.3 \times V_{DD}$	V
Control Input High	$0.7 \times V_{DD}$	—	—	V
Control Current	—	—	1	μA

Switching Specifications

Parameter	Min.	Typ.	Max.	Units
Switching Speed, 50% Control to 0.5dB of Attenuation Value	—	1.0	—	μSec
Switching Control Frequency	—	—	25	KHz

Absolute Maximum Ratings

Parameter	Ratings
Operating Temperature	-40°C to 85°C
Storage Temperature	-55°C to 100°C
V_{DD}	-0.3V Min., 4V Max.
Voltage on any input	-0.3V Min., $V_{DD}+0.3V$ Max.
ESD, HBM	500V
ESD, MM	100V
Input Power	+24dBm

Pin Description

Function	Pin Number	Description
C16	1	Control for Attenuation bit, 16dB (Note 3)
RF in	2	RF in port (Note 1)
N/C	3	Not connected (Note 4)
GND	4	Ground connection
LE	5	Latch Enable Input (Note 2)
V _{DD}	6	Power Supply
PUP1	7	Power-up selection
PUP2	8	Power-up selection
V _{DD}	9	Power Supply
GND	10	Ground connection
GND	11	Ground connection
GND	12	Ground connection
GND	13	Ground connection
RF out	14	RF out port (Note 1)
C8	15	Control for attenuation bit, 8 dB
C4	16	Control for attenuation bit, 4 dB
C2	17	Control for attenuation bit, 2 dB
GND	18	Ground Connection
C1	19	Control for attenuation bit, 1 dB
N/C	20	Not connected (Note 4)
GND	Paddle	Paddle ground (Note 5)

Notes:

- Both RF ports must be held at 0VDC or DC blocked with an external series capacitor.
- Latch Enable (LE) has an internal 100KΩ resistor to V_{DD}.
- Place a 10KΩ resistor in series, as close to pin as possible to avoid freq. resonance.
- Place a shunt 10KΩ resistor to GND.
- The exposed solder pad on the bottom of the package (See Pin Configuration) must be grounded for proper device operation.

Pin Configuration (Top View)

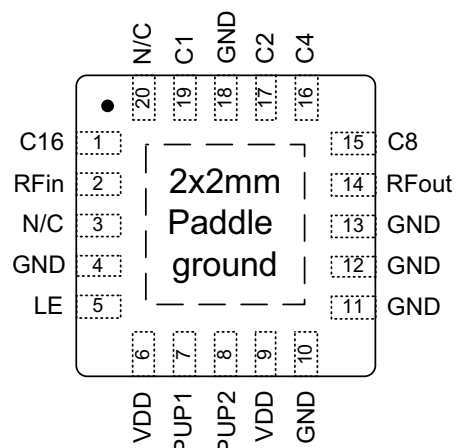

Digital Step Attenuator

DAT-31-PP+
DAT-31-PP

Typical Performance Curves

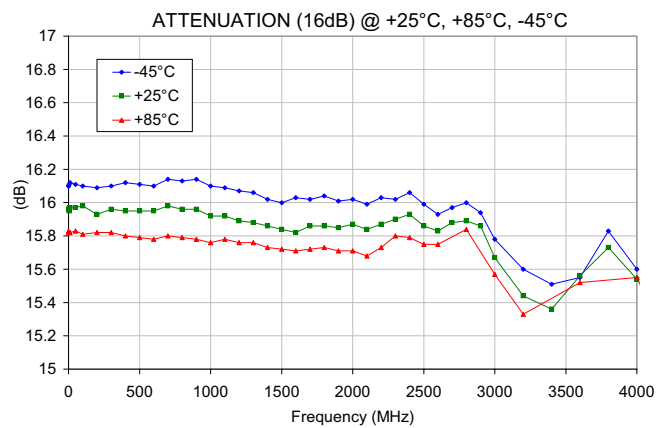
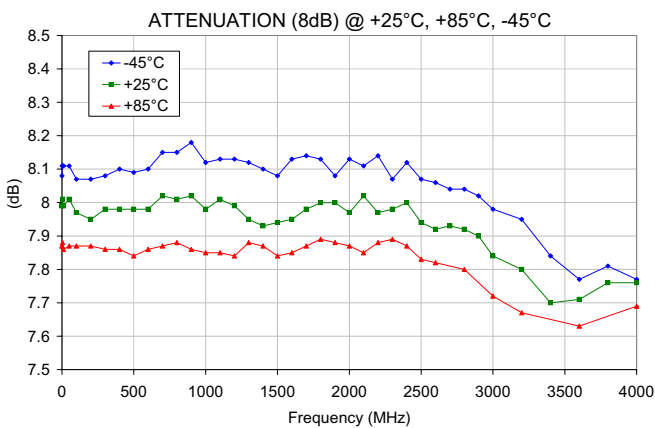
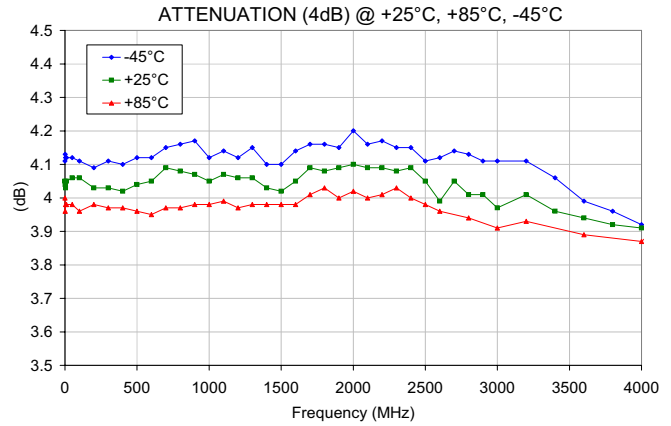
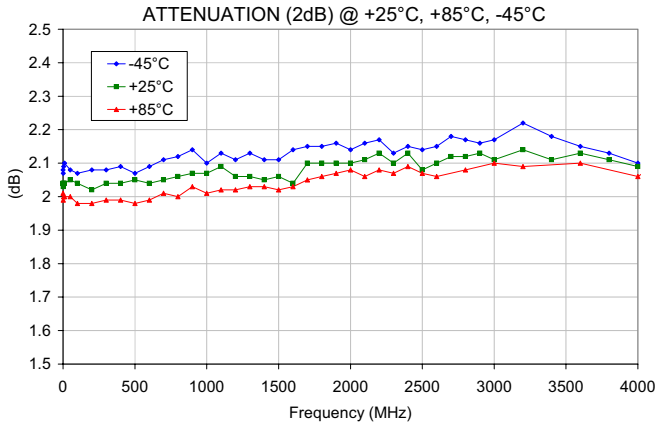
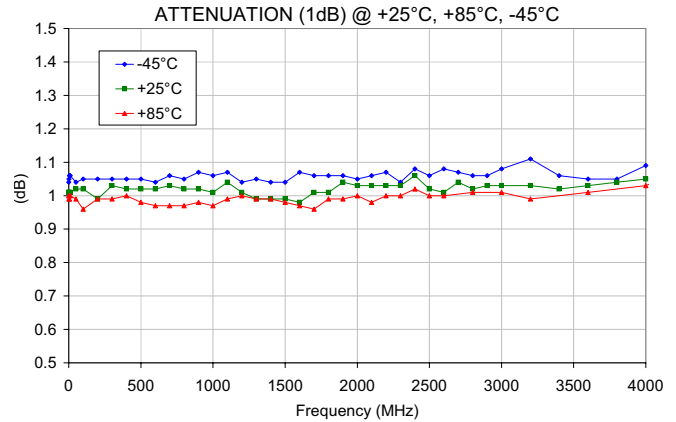
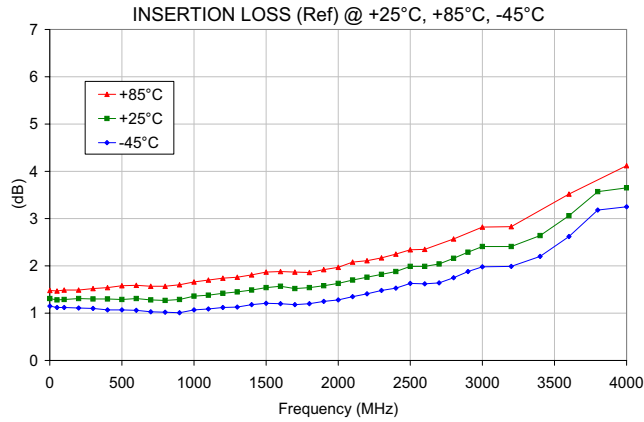

Typical Performance Curves

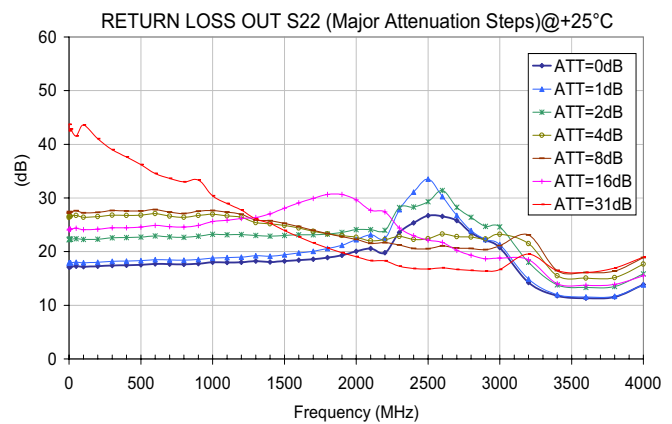
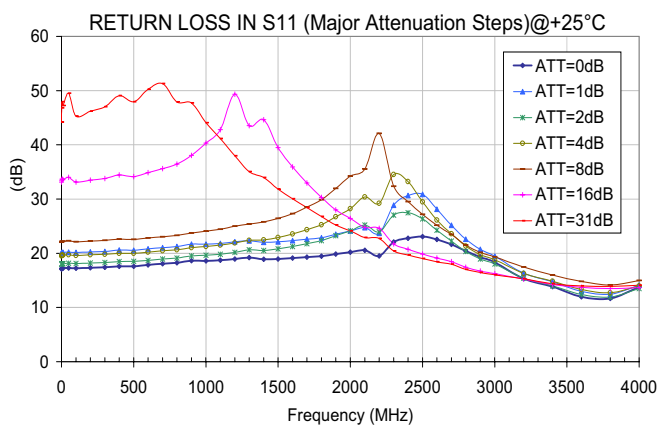
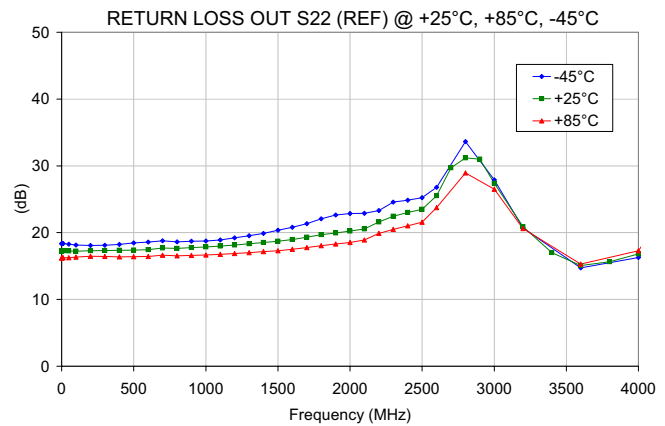
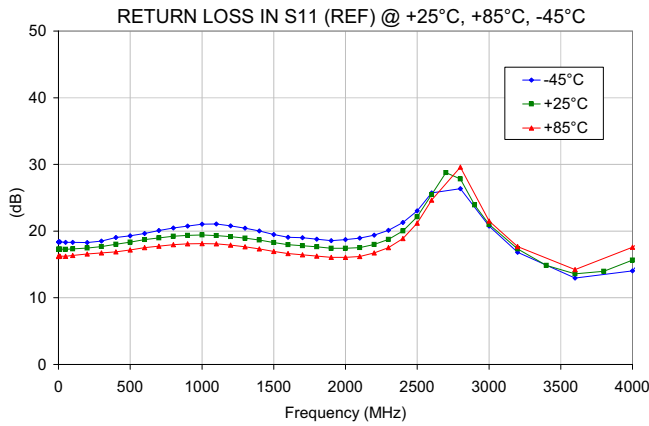
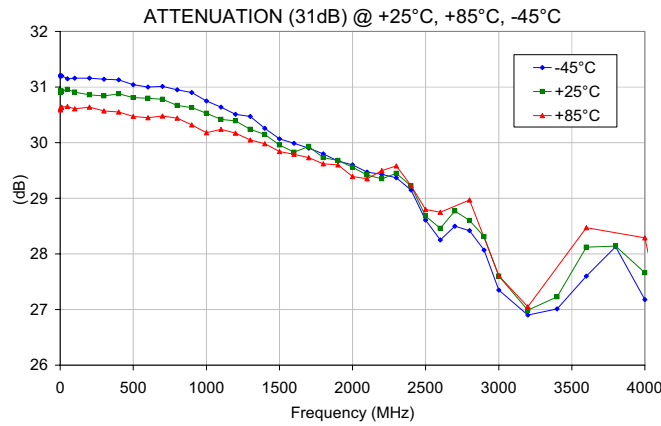

Digital Step Attenuator

Typical Performance Curves

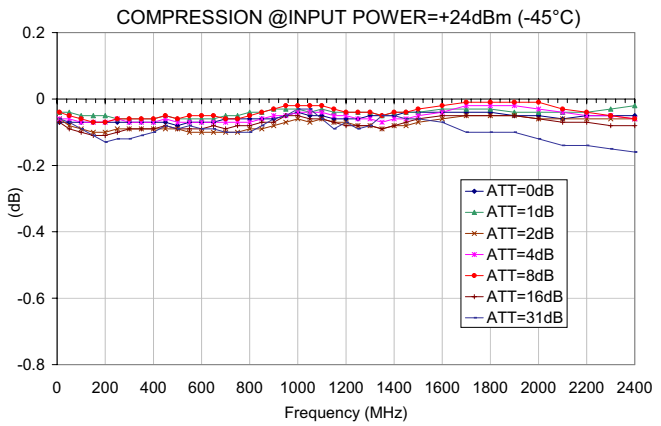
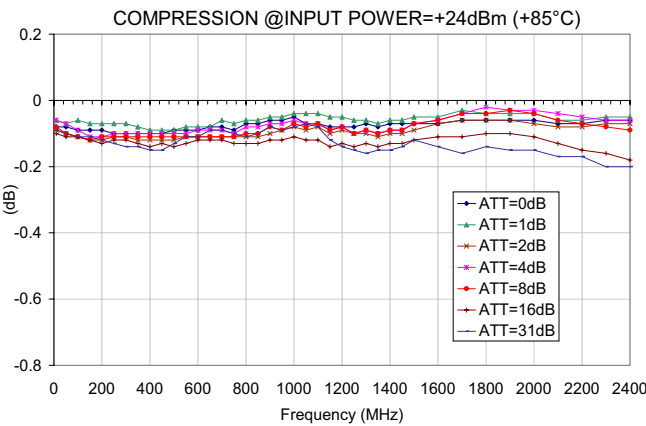
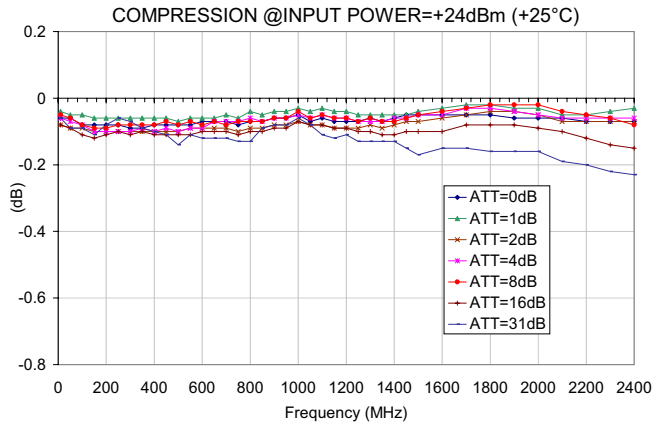
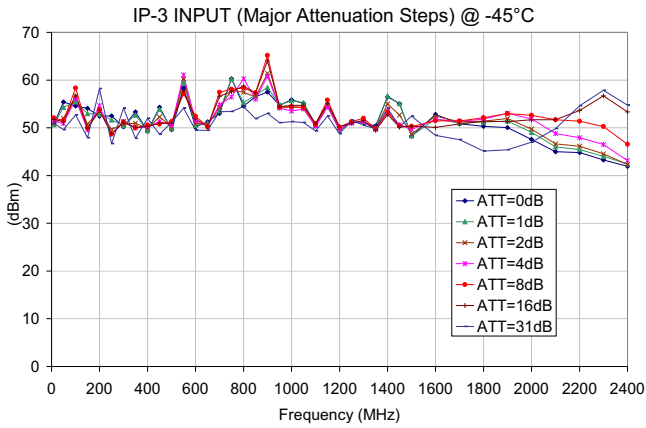
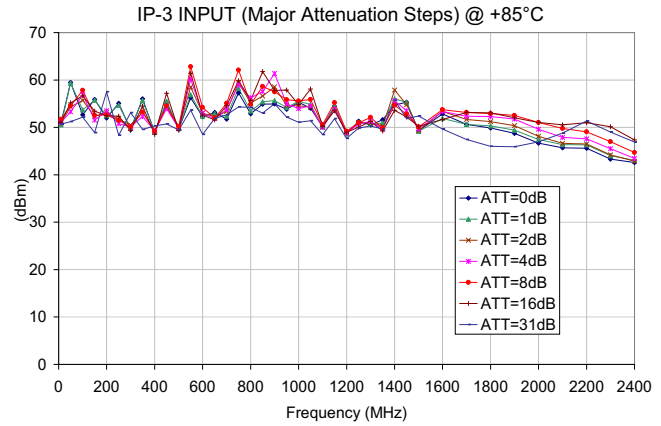
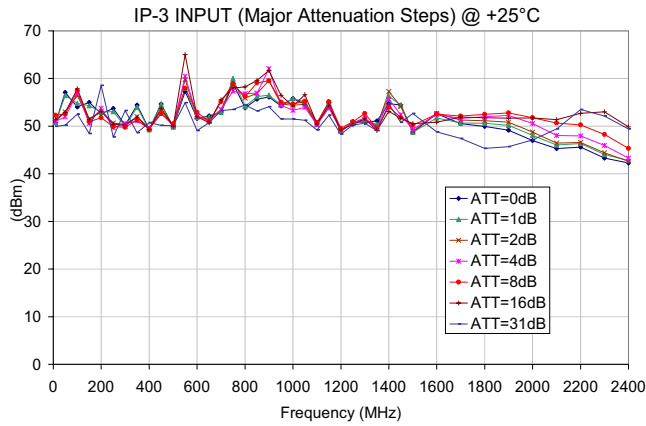

Outline Drawing (DG983-1)

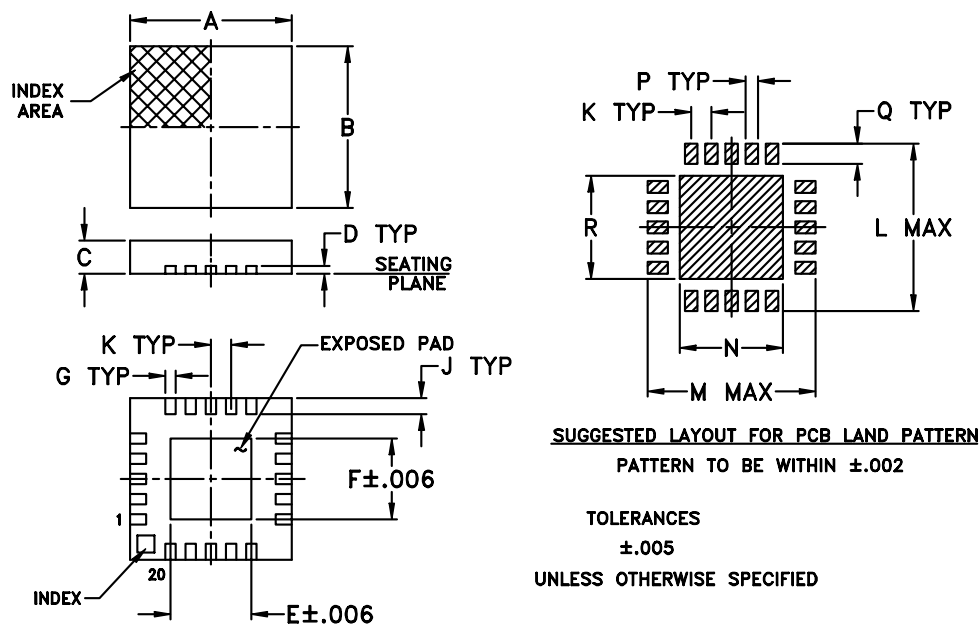

Device Marking

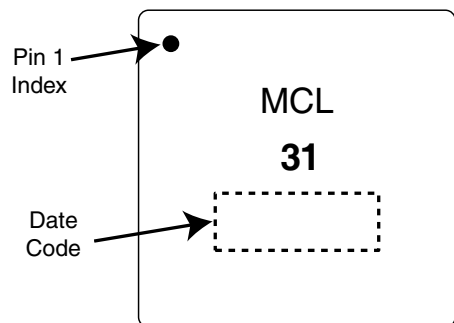

Outline Dimensions (inch/mm)

A	B	C	D	E	F	G	H	J	K	L	M	N	P	Q	R	WT. GRAMS
.157	.157	.035	.008	.081	.081	.010	—	.022	.020	.166	.166	.070	.012	.020	.070	.04
4.00	4.00	0.90	0.20	2.06	2.06	0.25	—	0.56	0.50	4.22	4.22	1.78	0.31	0.51	1.78	

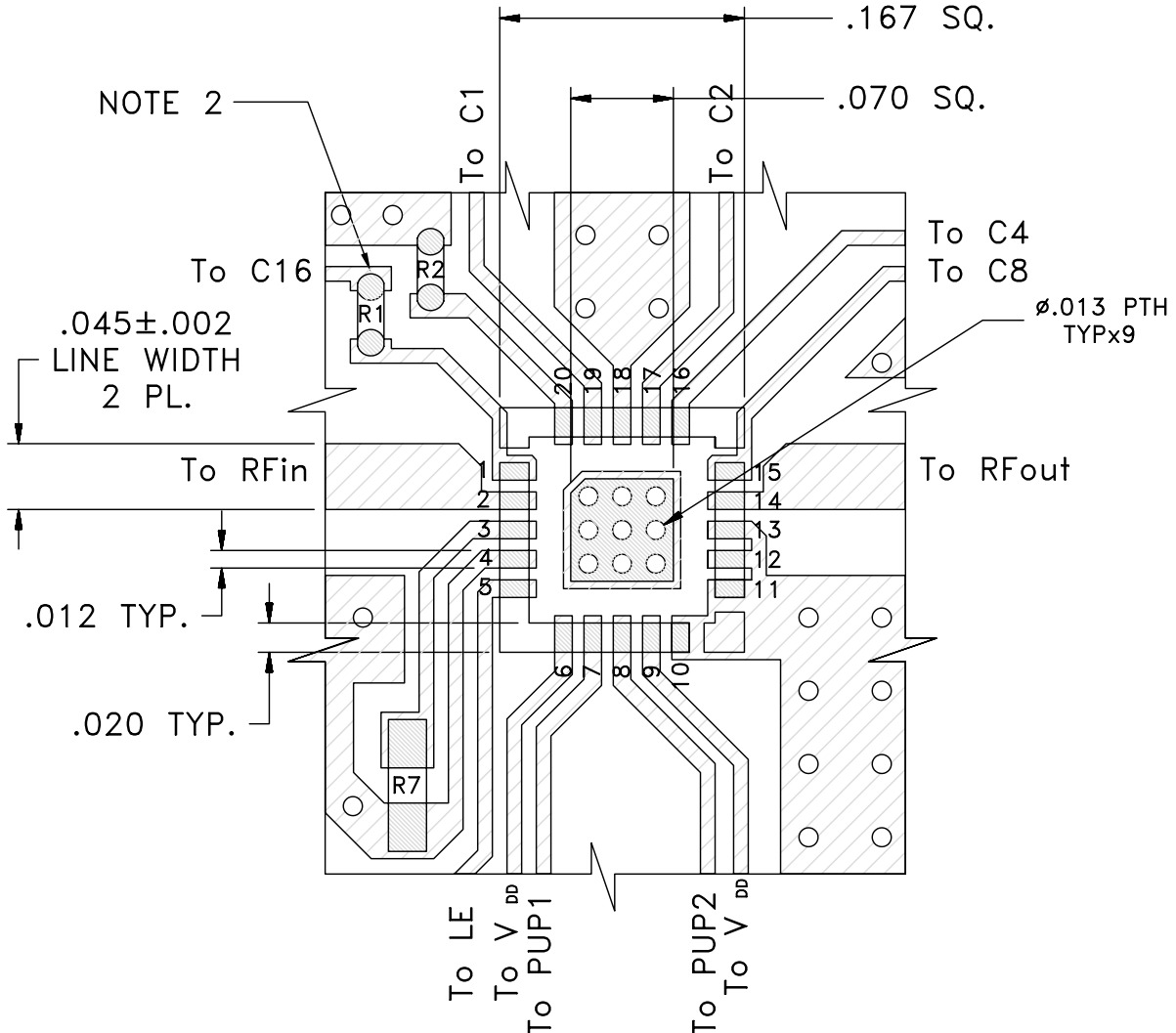

Suggested Layout for PCB Design (PL-189)

The suggested Layout shows only the footprint area of the DAT, and the components located near this area (i.e.: R1,R2, R7). For the complete Layout, see photo and schematic diagram on page 11 of 12.



NOTE:

1. TRACE WIDTH IS SHOWN FOR FR4 WITH DIELECTRIC THICKNESS .025"±.002". COPPER: 1/2 OZ. EACH SIDE. FOR OTHER MATERIALS TRACE WIDTH MAY NEED TO BE MODIFIED.
2. 0603, 0402 SIZES CHIP FOOT PRINTS SHOWN FOR REFERENCE, VALUES OF RESISTORS WILL VARY BASED ON APPLICATION.
3. BOTTOM SIDE OF THE PCB IS CONTINUOUS GROUND PLANE.

-  DENOTES PCB COPPER LAYOUT WITH SOMBC (SOLDER MASK OVER BARE COPPER)
-  DENOTES COPPER LAND PATTERN FREE OF SOLDERMASK

Digital Step Attenuator

Simplified Schematic

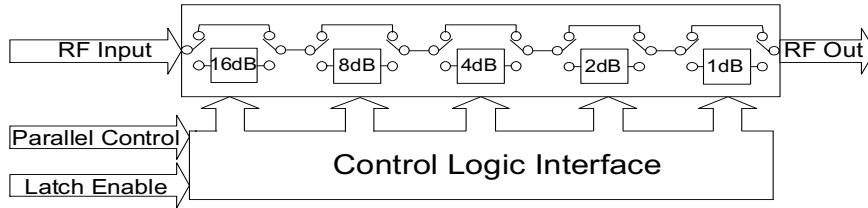

The DAT-31-PP parallel interface consists of 5 control bits that select the desired attenuation state, as shown in Table 1: Truth Table

Attenuation State	C16	C8	C4	C2	C1
Reference	0	0	0	0	0
1 (dB)	0	0	0	0	1
2 (dB)	0	0	0	1	0
4 (dB)	0	0	1	0	0
8 (dB)	0	1	0	0	0
16 (dB)	1	0	0	0	0
31 (dB)	1	1	1	1	1

Note: Not all 32 possible combinations of C1 - C16 are shown in table

The parallel interface timing requirements are defined by Figure 1 (Parallel Interface Timing Diagram) and Table 2 (Parallel Interface AC Characteristics), and switching speed.

For latched parallel programming the Latch Enable (LE) should be held LOW while changing attenuation state control values, then pulse LE HIGH to LOW (per Figure 1) to latch new attenuation state into device.

For direct parallel programming, the Latch Enable (LE) line should be pulled HIGH. Changing attenuation state control values will change device state to new attenuation. Direct mode is ideal for manual control of the device (using hardware, switches, or jumpers).

Figure 1: Parallel Interface Timing Diagram

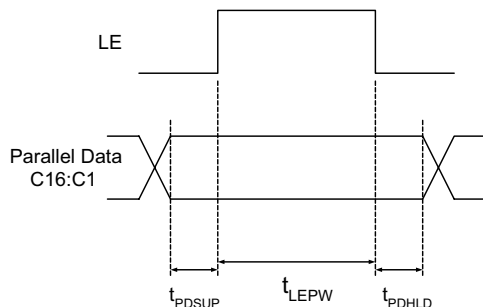

Symbol	Parameter	Min.	Max.	Units
t_{LEPW}	LE minimum pulse width	10		ns
t_{PDSUP}	Data set-up time before clock rising edge of LE	10		ns
t_{PDHL}	Data hold time after clock falling edge of LE	10		ns

Pin 20 must always be low to prevent the attenuator from entering an unknown state.

Power-up Control Settings

The DAT-31-PP always assumes a specifiable attenuation setting on power-up, allowing a known attenuation state to be established before an initial parallel control word is provided.

When the attenuator powers up with LE=0, the control bits are automatically set to one of four possible values. These four values are selected by the two power-up control bits, PUP1 and PUP2, as shown in table 3: (Power-Up Truth Table, Parallel Mode).

Table 3. Power-Up Truth Table, Parallel Mode			
Attenuation State	PUP1	PUP2	LE
Reference	0	0	0
8 (dB)	0	1	0
16 (dB)	1	0	0
31 (dB)	1	1	0
Defined by C1-C16 (See Table 1-Truth Table)	X (Note 1)	X (Note 1)	1

Note 1: PUP1 and PUP2 Connection may be 0, 1, GROUND, or not connect, without effect on attenuation state.

Power-Up with LE=1 provides normal parallel operation with C1-C16, and PUP1 and PUP2 are not active.

TB-339 Evaluation Board Schematic Diagram

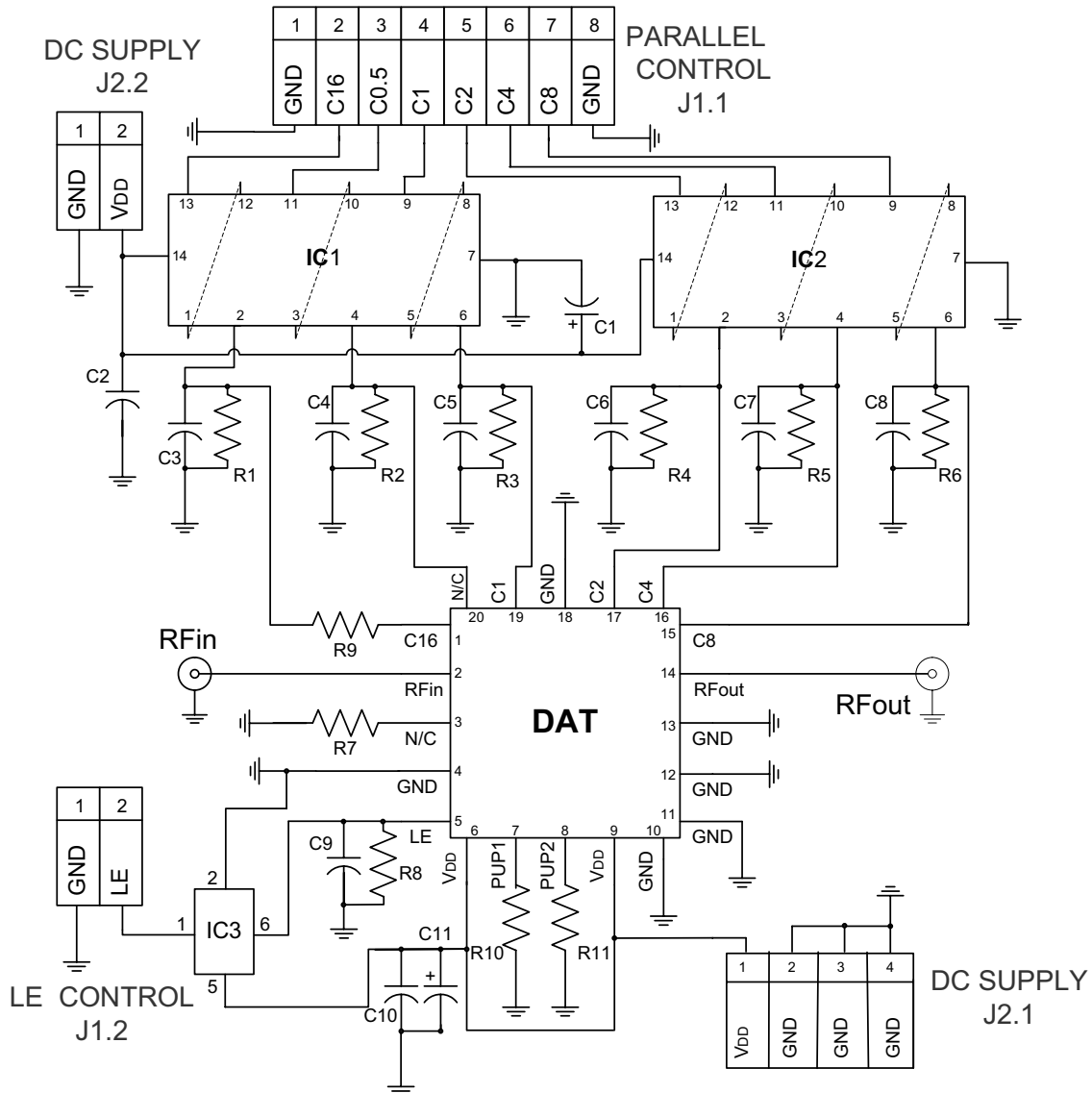

Bill of Materials	
R1 - R8	Resistor 0603 10 KOhm +/- 1%
R10, R11	Resistor 0603 470 Ohm +/- 1%
R9	Resistor 0402 10 KOhm +/- 1%
C2 - C10	NPO Capacitor 0603 100 pF +/-5%
C1, C11	Tantalum Capacitor 100 nF +/-10%
IC1, IC2	Hex inverting Schmitt trigger MM74HC14
IC3	Dual non-inverting Schmitt trigger SN74LVC2G17

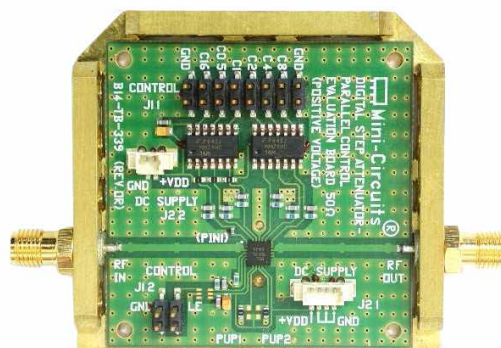

TB-339

Tape and Reel Packaging Information

Table T&R

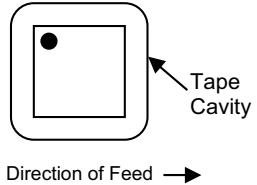
TR No.	No. of Devices	Designation Letter	Reel Size	Tape Width	Pitch	Unit Orientation
T-005	1000	K	7 inch	12 mm	8 mm	
	2000	T	13 inch			
	multiples of 10, less than full reel of 1K	PR	7 inch			
	multiples of 10, on tape only	E	not applicable			

Ordering Information

Model No.	Description	Packaging Designation Letter (See Table T&R)	Quantity Min. No. of Units	Price \$ Ea.
DAT-31-PP (+)	Parallel Interface, Single Positive Voltage	E	10	\$3.55
TB-339	Test Board Only	Not Applicable	1	\$79.95

How to Order

Example: 1000 pieces of DAT-31-PP+

