

3 band car audio processor

Features

- Input multiplexer
 - QD1: quasi-differential stereo inputs
 - SE1: stereo single-ended input
 - SE2: stereo single-ended input
 - SE3: stereo single-ended input
 - FD1 / SE4+SE5: 1 full-differential input or 2 stereo single-ended inputs
- Loudness
 - 2nd order frequency response
 - Programmable center frequency (400 Hz / 800 Hz / 2400 Hz)
 - 15 dB with 1 dB steps
 - Selectable high frequency boost
 - Selectable flat-mode (constant attenuation)
- Volume
 - +23 dB to -31 dB with 1 dB step resolution
 - Soft-step control with programmable blend times
- Bass
 - 2nd order frequency response
 - Center frequency programmable in 4 steps (60 Hz / 80 Hz / 100 Hz / 200 Hz)
 - Q programmable 1.0/1.25/1.5/2.0
 - DC gain programmable
 - -15 dB to 15 dB range with 1 dB resolution
- Middle
 - 2nd order frequency response
 - Center frequency programmable in 4 steps (500 Hz / 1 kHz / 1.5 kHz / 2.5 kHz)
 - Q programmable 0.75/1.0/1.25
 - -15 dB to 15 dB range with 1 dB resolution
- Treble
 - 2nd order frequency response (10 kHz / 12.5 kHz / 15 kHz / 17.5 kHz)
 - Center frequency programmable in 4 steps (10 kHz / 12.5 kHz / 15 kHz / 17.5 kHz)
 - -15 dB to 15 dB with 1 dB resolution

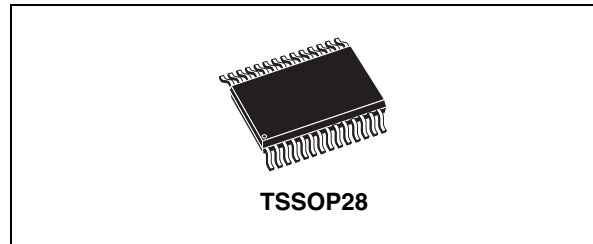

- Speaker
 - 4 independent soft step speaker controls
 - +15 dB to -79 dB with 1 dB steps
 - Direct mute
- Subwoofer
 - 2nd order low pass filter with programmable cut off frequency (55 Hz / 85 Hz / 120 Hz / 160 Hz)
 - 2 independent soft step level control, +15 dB to -79 dB with 1 dB steps
- Mute functions
 - Direct mute
 - Digitally controlled SoftMute with 4 programmable mute-times (0.48 ms/0.96 ms/8 ms/16 ms)
- Offset detection
 - Offset voltage detection circuit for on-board power amplifier failure diagnosis

Description

The TDA7718N is a high performance signal processor specifically designed for car radio applications. The device includes a high performance audioprocessor with fully integrated audio filters and new Soft Step architecture. The digital control allows programming in a wide range of filter characteristics.

Table 1. Device summary

Order code	Package	Packing
TDA7718N	TSSOP28	Tube
TDA7718NTR	TSSOP28	Tape and reel

Contents

- 1 Block circuit diagram 6**
- 2 Pin connection and pin description 7**
 - 2.1 Pin connection 7
 - 2.2 Pin description 7
- 3 Electrical specifications 9**
 - 3.1 Thermal data 9
 - 3.2 Absolute maximum ratings 9
 - 3.3 Electrical characteristics 9
- 4 Description of the audioprocessor 13**
 - 4.1 Input stages 13
 - 4.1.1 Quasi-differential stereo input (QD1) 13
 - 4.1.2 Single-ended stereo input (SE1, SE2, SE3) 13
 - 4.1.3 Full-differential stereo input or single-ended input (FD1/QD2/SE4+SE5) 13
 - 4.2 Loudness 15
 - 4.2.1 Loudness attenuation 15
 - 4.2.2 Peak frequency 15
 - 4.2.3 High frequency boost 16
 - 4.2.4 Flat mode 16
 - 4.3 SoftMute 17
 - 4.4 SoftStep volume 17
 - 4.5 Bass 18
 - 4.5.1 Bass attenuation 18
 - 4.5.2 Bass center frequency 18
 - 4.5.3 Quality factors 19
 - 4.5.4 DC mode 19
 - 4.6 Middle 20
 - 4.6.1 Middle attenuation 20
 - 4.6.2 Middle center frequency 20
 - 4.6.3 Quality factors 21
 - 4.7 Treble 21

4.7.1	Treble attenuation	21
4.7.2	Center frequency	22
4.8	Subwoofer filter	22
4.9	Softstep control	23
4.10	DC offset detector	23
4.11	Audioprocessor testing	25
5	I²C bus specification	26
5.1	Interface protocol	26
5.2	I ² C bus electrical characteristics	26
5.2.1	Receive mode	27
5.2.2	Transmission mode	27
5.2.3	Reset condition	27
5.3	Data byte specification	29
6	Package information	38
7	Revision history	39

List of tables

Table 1.	Device summary	1
Table 2.	Pin description	7
Table 3.	Thermal data	9
Table 4.	Absolute maximum ratings	9
Table 5.	Electrical characteristics	9
Table 6.	I ² C bus electrical characteristics	26
Table 7.	Subaddress (receive mode)	28
Table 8.	Main selector (0)	29
Table 9.	Soft mute / others (4)	30
Table 10.	SoftStep I (5)	31
Table 11.	SoftStep II / DC detector (6)	32
Table 12.	Loudness (7)	33
Table 13.	Volume / output gain (8)	33
Table 14.	Treble filter (9)	34
Table 15.	Middle filter (10)	34
Table 16.	Bass filter (11)	35
Table 17.	Subwoofer / middle / bass (12)	35
Table 18.	Speaker attenuation (FL/FR/RL/RR/SWL/SWR) (13-18)	36
Table 19.	Testing audio processor 1 (19)	36
Table 20.	Testing audio processor 2 (20)	37
Table 21.	Testing audio processor 3 (21)	37
Table 22.	Document revision history	39

List of figures

Figure 1.	Block circuit diagram.	6
Figure 2.	Pin connection (top view)	7
Figure 3.	FD / QD / SE block diagram	14
Figure 4.	Loudness attenuation @ $f_P = 400$ Hz.	15
Figure 5.	Loudness center frequencies @ attn. = 15 dB.	15
Figure 6.	Loudness attenuation, $f_C = 2.4$ kHz.	16
Figure 7.	SoftMute timing.	17
Figure 8.	Bass control @ $f_C = 80$ Hz, $Q = 1$	18
Figure 9.	Bass center frequencies @ gain = 14 dB, $Q = 1$	18
Figure 10.	Bass quality factors @ gain = 14 dB, $f_C = 80$ Hz	19
Figure 11.	Bass normal and DC mode @ gain = 14 dB, $f_C = 80$ Hz	19
Figure 12.	Middle control @ $f_C = 1$ kHz, $Q = 1$	20
Figure 13.	Middle center frequencies @ gain = 14 dB, $Q = 1$	20
Figure 14.	Middle quality factors @ gain = 14 dB, $f_C = 1$ kHz	21
Figure 15.	Treble control @ $f_C = 17.5$ kHz.	21
Figure 16.	Treble center frequencies @ gain = 14 dB.	22
Figure 17.	Subwoofer cut frequencies	22
Figure 18.	DC offset detection circuit (simplified)	24
Figure 19.	Test circuit	25
Figure 20.	I ² C bus interface protocol	26
Figure 21.	I ² C bus data	27
Figure 22.	TSSOP28 mechanical data and package dimensions	38

1 Block circuit diagram

Figure 1. Block circuit diagram

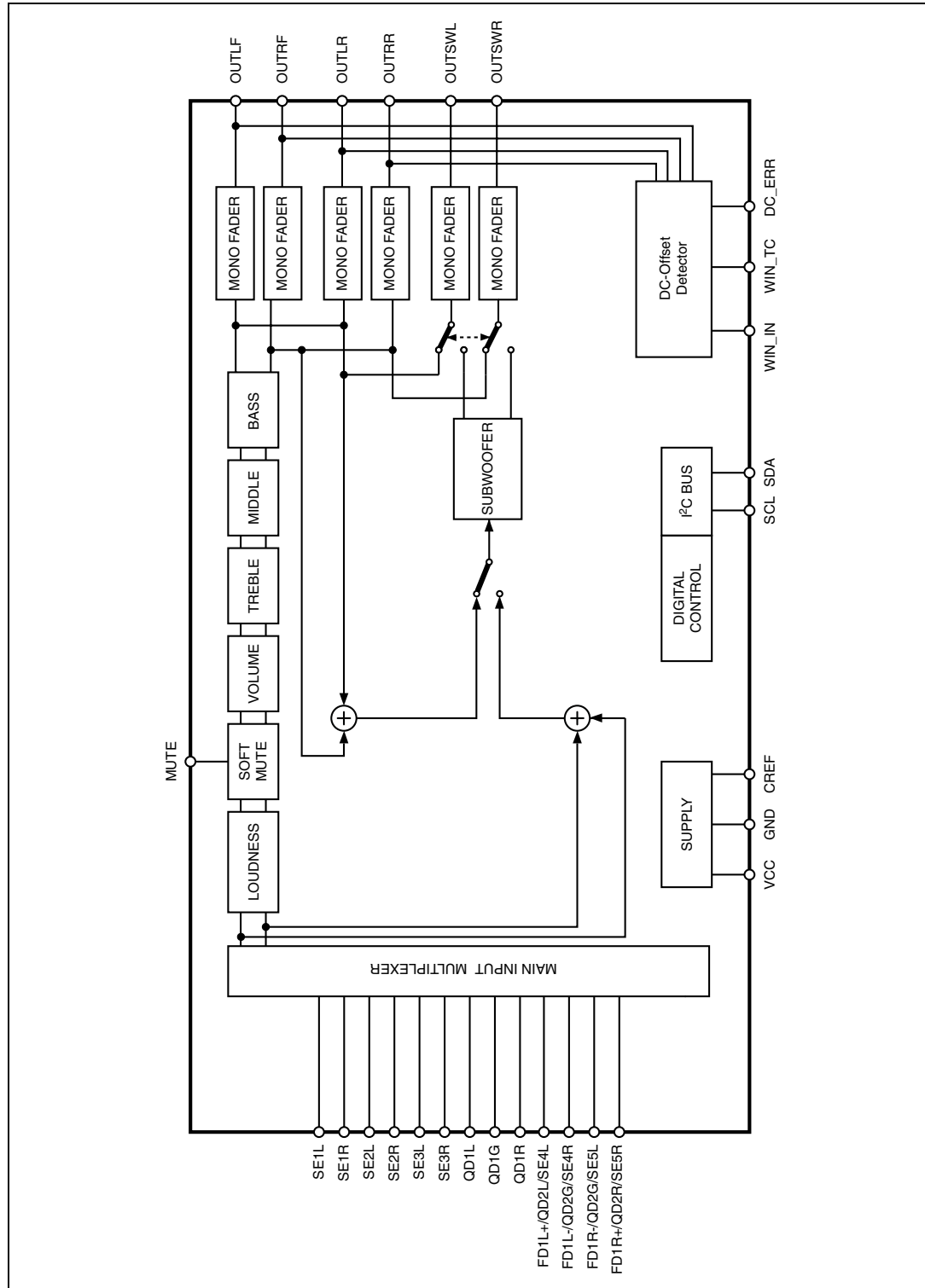

2 Pin connection and pin description

2.1 Pin connection

Figure 2. Pin connection (top view)

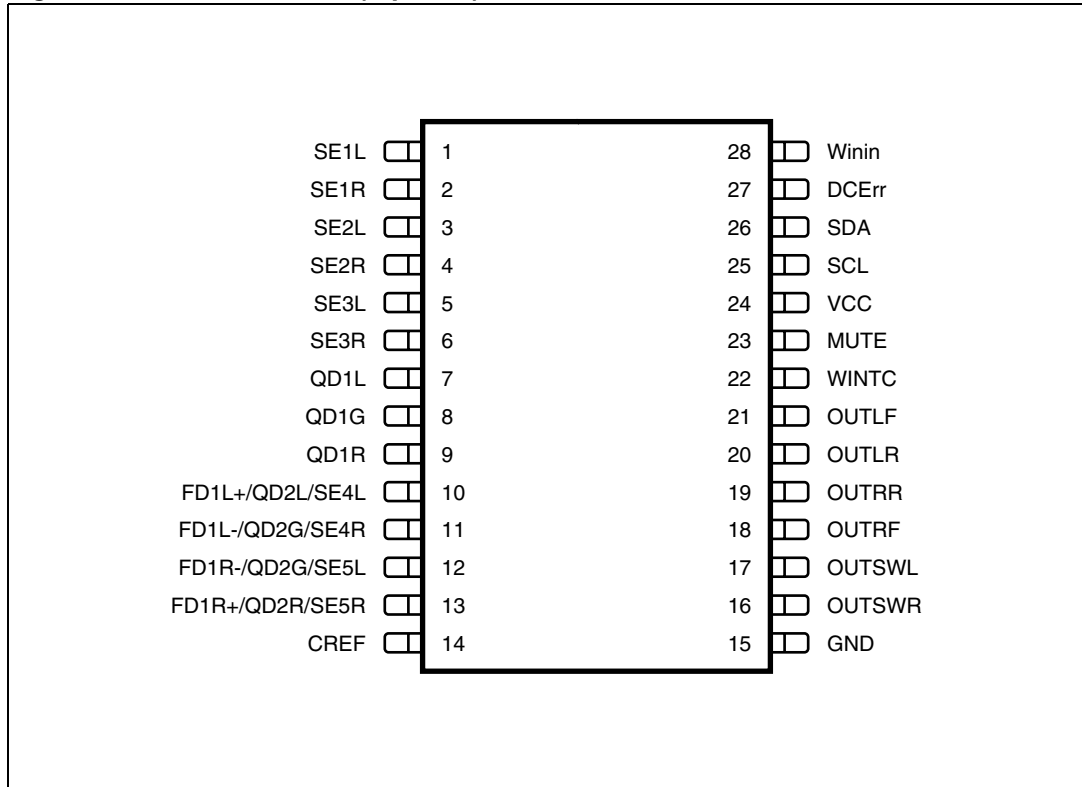

2.2 Pin description

Table 2. Pin description

No.	Pin name	Description	I/O
1	SE1L	Single-end input left	I
2	SE1R	Single-end input right	I
3	SE2L	Single-end input left	I
4	SE2R	Single-end input right	I
5	SE3L	Single-end input left	I
6	SE3R	Single-end input right	I
7	QD1L	quasi-differential stereo inputs left	I
8	QD1G	quasi-differential stereo inputs common	I
9	QD1R	quasi-differential stereo inputs right	I
10	FD1L+/QD2L/SE4L	Full differential + input left or quasi-differential left or single-end input left	I

Table 2. Pin description (continued)

No.	Pin name	Description	I/O
11	FD1L-/QD2G/SE4R	Full differential - input left or quasi-differential ground or single-end input right	I
12	FD1R-/QD2G/SE5L	Full differential - input right or quasi-differential ground or single-end input left	I
13	FD1R+/QD2R/SE5R	Full differential + input right or quasi-differential right or single-end input right	I
14	CREF	Reference capacitor	O
15	GND	Ground	S
16	OUTSWR	Subwoofer right output	O
17	OUTSWL	Subwoofer left output	O
18	OUTRF	Front right output	O
19	OUTRR	Rear right output	O
20	OUTLR	Rear left output	O
21	OUTLF	Front left output	O
22	WinTC	DC offset detector filter output	O
23	MUTE	External mute pin	I
24	VCC	Supply	S
25	SCL	I ² C bus clock	I
26	SDA	I ² C bus data	I/O
27	DC_ERR	DC offset detector output	O
28	WIN_IN	DC offset detector input	I

3 Electrical specifications

3.1 Thermal data

Table 3. Thermal data

Symbol	Description	Value	Unit
$R_{th-j\ amb}$	Thermal resistance junction-to-ambient	114	°C/W

3.2 Absolute maximum ratings

Table 4. Absolute maximum ratings

Symbol	Parameter	Value	Unit
V_S	Operating supply voltage	10.5	V
V_{in_max}	Maximum voltage for signal input pins	7	V
T_{amb}	Operating ambient temperature	-40 to 85	°C
T_{stg}	Storage temperature range	-55 to 150	°C

3.3 Electrical characteristics

$V_S = 8.5\text{ V}$; $T_{amb} = 25\text{ °C}$; $R_L = 10\text{ k}\Omega$; all gains = 0 dB; $f = 1\text{ kHz}$; unless otherwise specified

Table 5. Electrical characteristics

Symbol	Parameter	Test condition	Min.	Typ.	Max.	Unit
Supply						
V_S	Supply voltage	-	7.5	8.5	10	V
I_S	Supply current	-	23	29	35	mA
Input selector						
R_{in}	Input resistance	All single ended inputs	70	100	130	k Ω
V_{CL}	Clipping level	Input gain = 0 dB	2	-	-	V_{RMS}
S_{IN}	Input separation	-	-	95	-	dB
Differential stereo inputs						
R_{in}	Input resistance	Differential	70	100	-	k Ω
CMRR	Common mode rejection ratio for main source	$V_{CM} = 1\text{ V}_{RMS}$ @ 1 kHz	44	60	-	dB
		$V_{CM} = 1\text{ V}_{RMS}$ @ 10 kHz	44	60	-	dB
e_{No}	Output noise @ speaker outputs	20 Hz - 20 kHz, A-weighted; all stages 0 dB	-	12	22	μV

Table 5. Electrical characteristics (continued)

Symbol	Parameter	Test condition	Min.	Typ.	Max.	Unit
Loudness control						
A_{MAX}	Max attenuation	-	14	15	16	dB
A_{STEP}	Step resolution	-	0.5	1	1.5	dB
f_{Peak}	Peak frequency	f_{P1}	-	400	-	Hz
		f_{P2}	-	800	-	Hz
		f_{P3}	-	2400	-	Hz
Volume control						
G_{MAX}	Max gain	-	22	23	24	dB
A_{MAX}	Max attenuation	-	-	-31	-30	dB
A_{STEP}	Step resolution	-	0.5	1	1.5	dB
E_A	Attenuation set error	-	-0.75	0	+0.75	dB
E_T	Tracking error	-	-	-	2	dB
V_{DC}	DC steps	Adjacent attenuation steps	-3	0.1	3	mV
		From 0 dB to G_{MIN}	-5	0.5	5	mV
Soft mute						
A_{MUTE}	Mute attenuation	-	80	100	-	dB
T_D	Delay time	T1	0.35	0.48	0.65	ms
		T2	0.7	0.96	1.3	ms
		T3	5.6	7.6	9.6	ms
		T4	12.3	15.3	18.3	ms
$V_{TH\ Low}$	Low threshold for SM pin	-	-	-	1	V
$V_{TH\ High}$	High threshold for SM pin	-	2.5	-	-	V
R_{PU}	Internal pull-up resistor	-	32	45	58	k Ω
V_{PU}	Internal pull-up voltage	-	3	3.3	3.6	V
Bass control						
F_c	Center frequency	f_{C1}	-	60	-	Hz
		f_{C2}	-	80	-	Hz
		f_{C3}	-	100	-	Hz
		f_{C4}	-	200	-	Hz
Q_{BASS}	Quality factor	Q_1	-	1	-	-
		Q_2	-	1.25	-	-
		Q_3	-	1.5	-	-
		Q_4	-	2	-	-
C_{RANGE}	Control range	-	± 14	± 15	± 16	dB
A_{STEP}	Step resolution	-	0.5	1	1.5	dB
DC_{GAIN}	Bass-DC-gain	DC = off	-1	0	+1	dB
		DC = on, gain = ± 15 dB	± 4.3	± 4.7	± 5.1	dB

Table 5. Electrical characteristics (continued)

Symbol	Parameter	Test condition	Min.	Typ.	Max.	Unit
Middle control						
C _{RANGE}	Control range	-	±14	±15	±16	dB
A _{STEP}	Step resolution	-	0.5	1	1.5	dB
f _c	Center frequency	f _{C1}	-	500	-	Hz
		f _{C2}	-	1	-	kHz
		f _{C3}	-	1.5	-	kHz
		f _{C4}	-	2.5	-	kHz
Q _{MIDDLE}	Quality factor	Q ₁	-	0.75	-	-
		Q ₂	-	1	-	-
		Q ₃	-	1.25	-	-
Treble control						
C _{RANGE}	Clipping level	-	±14	±15	±16	dB
A _{STEP}	Step resolution	-	0.5	1	1.5	dB
f _c	Center frequency	f _{C1}	-	10	-	kHz
		f _{C2}	-	12.5	-	kHz
		f _{C3}	-	15	-	kHz
		f _{C4}	-	17.5	-	kHz
Speaker attenuators						
G _{MAX}	Max gain	-	14	15	16	dB
A _{MAX}	Max attenuation	-	-	-79	-74	dB
A _{STEP}	Step resolution	-	0.5	1	1.5	dB
A _{MUTE}	Mute attenuation	-	80	90	-	dB
E _E	Attenuation set error	-	-	-	2	dB
V _{DC}	DC steps	Adjacent attenuation steps	-	0.1	5	mV
Audio outputs						
V _{CL}	Clipping level	d = 0.3 %; byte8_D6=1	2	-	-	V _{RMS}
		d = 1 %; byte8_D6=0	2.2	-	-	V _{RMS}
R _{OUT}	Output impedance	-	-	30	100	Ω
R _L	Output load resistance	-	2	-	-	kΩ
C _L	Output load capacitor	-	-	-	10	nF
V _{DC}	DC voltage level	-	3.8	4.0	4.2	V
Subwoofer lowpass						
f _{LP}	Lowpass corner frequency	f _{LP1}	-	55	-	Hz
		f _{LP2}	-	85	-	Hz
		f _{LP3}	-	120	-	Hz
		f _{LP4}	-	160	-	Hz

Table 5. Electrical characteristics (continued)

Symbol	Parameter	Test condition	Min.	Typ.	Max.	Unit
DC offset detection circuit						
V_{th}	Zero comp. window size	V1	±10	±25	±40	mV
		V2	±30	±50	±70	mV
		V3	±50	±75	±100	mV
		V4	±70	±100	±130	mV
t_{sp}	Max rejected spike length	-	2	11	30	µs
		-	5	22	50	µs
		-	10	33	70	µs
		-	15	44	90	µs
$I_{CHDCerr}$	DCErr charge current	-	2	5	8	µA
$I_{DISDCerr}$	DCErr discharge current	-	4	5	9	mA
V_{OutH}	DCErr high voltage	-	3	3.3	3.6	V
V_{OutL}	DCErr low voltage	-	-	100	300	mV
General						
e_{NO}	Output noise	BW=20 Hz to 20 kHz A-Weighted, all gain = 0 dB	-	12	22	µV
		BW=20 Hz - 20 kHz A-Weighted, Output muted	-	7	12	µV
S/N	Signal to noise ratio	all gain = 0 dB, A-weighted; $V_o = 2 V_{RMS}$	98	104	-	dB
D	Distortion	$V_{IN} = 1 V_{RMS}$; all stages 0 dB	-	0.01	0.1	%
S_C	Channel separation left/right	-	-	90	-	dB

4 Description of the audioprocessor

4.1 Input stages

One quasi-differential stereo input, one full-differential stereo input and maximum five single-ended inputs are available.

4.1.1 Quasi-differential stereo input (QD1)

The QD input is implemented as a buffered quasi-differential stereo stage with 100 k Ω input-impedance at each input. There is -3 dB attenuation at QD input stage.

4.1.2 Single-ended stereo input (SE1, SE2, SE3)

The input-impedance at each input is 100 k Ω and the attenuation is fixed to -3 dB for incoming signals.

4.1.3 Full-differential stereo input or single-ended input (FD1/QD2/SE4+SE5)

This device provides a full-differential stereo input stage (FD1) or 2nd quasi-differential stereo input stage. The full differential is a buffered full-differential stereo stage with 100 k Ω input-impedance at each input. When using as QD2 application, it needs to connect the two QD2G pins together from external and the input impedance at QDG becomes 50 k Ω . This stage can be also configured as 2 single-ended stereo input stages (SE4 and SE5). The configuration is done with the input selector control bits and the selection of FD1 and QD2 is controlled by a separate bit. There is -3 dB attenuation at the input stage. [Figure 3](#) shows the block diagram of this input stage.

Figure 3. FD / QD / SE block diagram

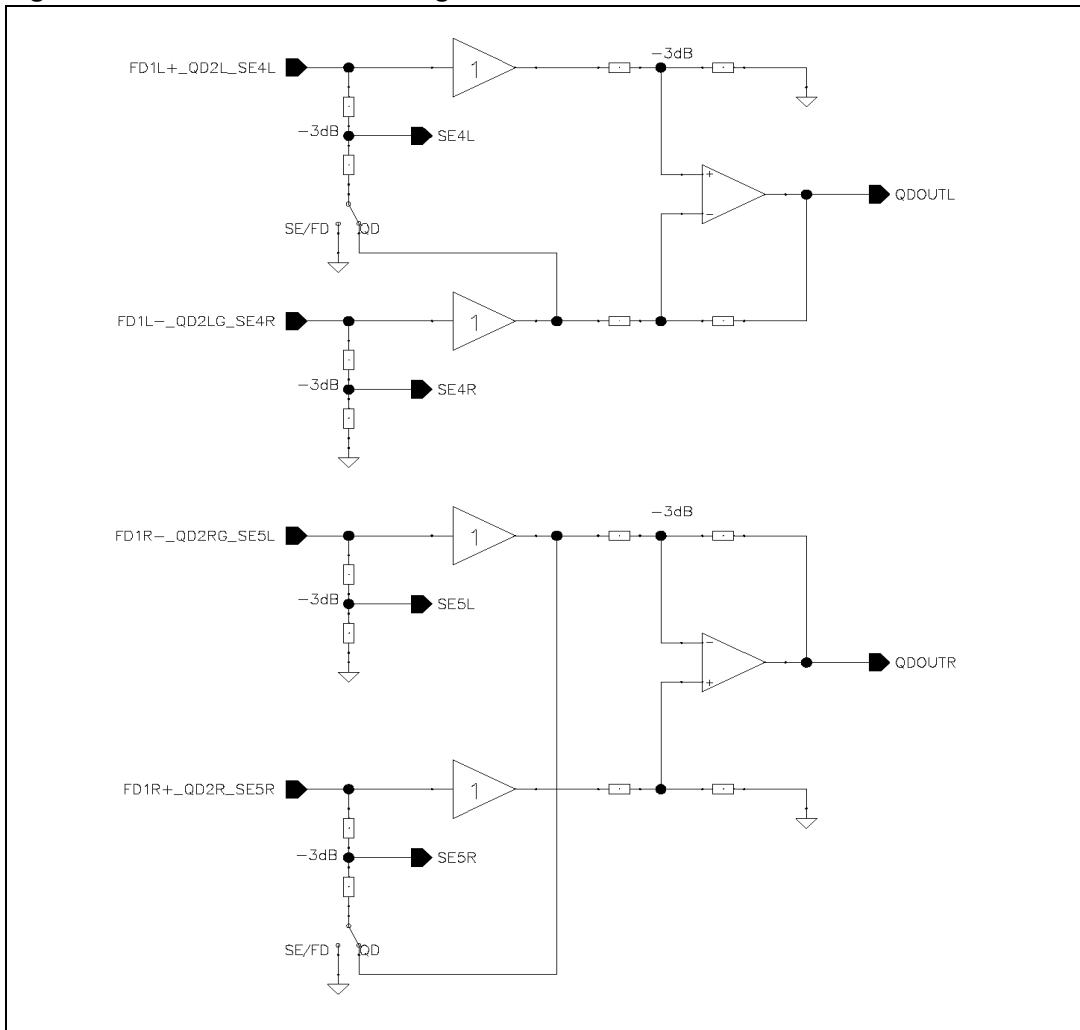

4.2 Loudness

There are four parameters programmable in the loudness stage.

4.2.1 Loudness attenuation

Figure 4 shows the attenuation as a function of frequency at $f_p = 400$ Hz.

Figure 4. Loudness attenuation @ $f_p = 400$ Hz.

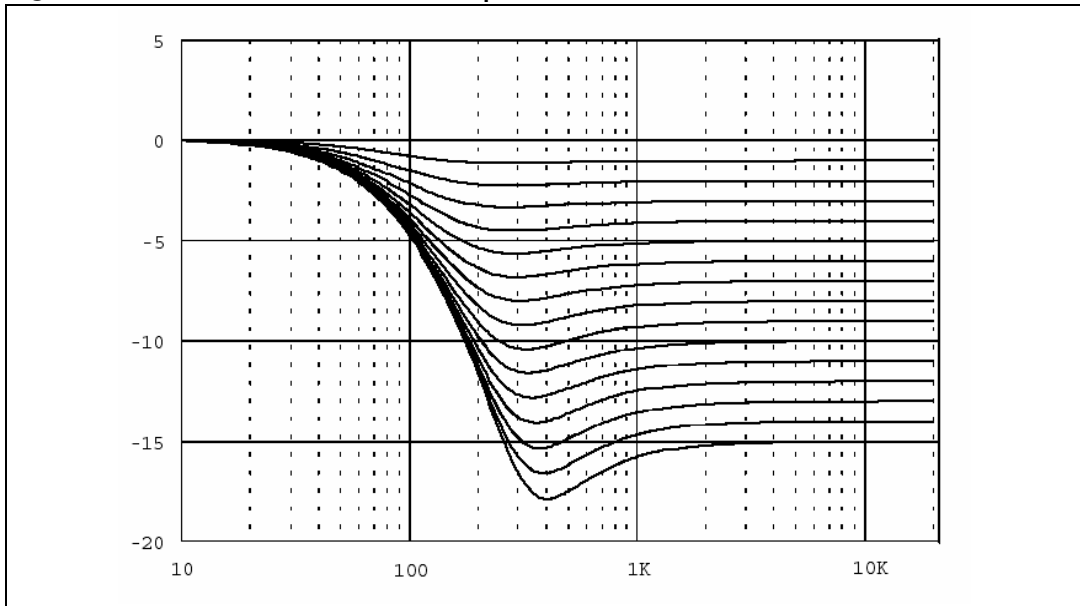

4.2.2 Peak frequency

Figure 5 shows the four possible peak-frequencies at 400, 800 and 2400 Hz.

Figure 5. Loudness center frequencies @ attn. = 15 dB.

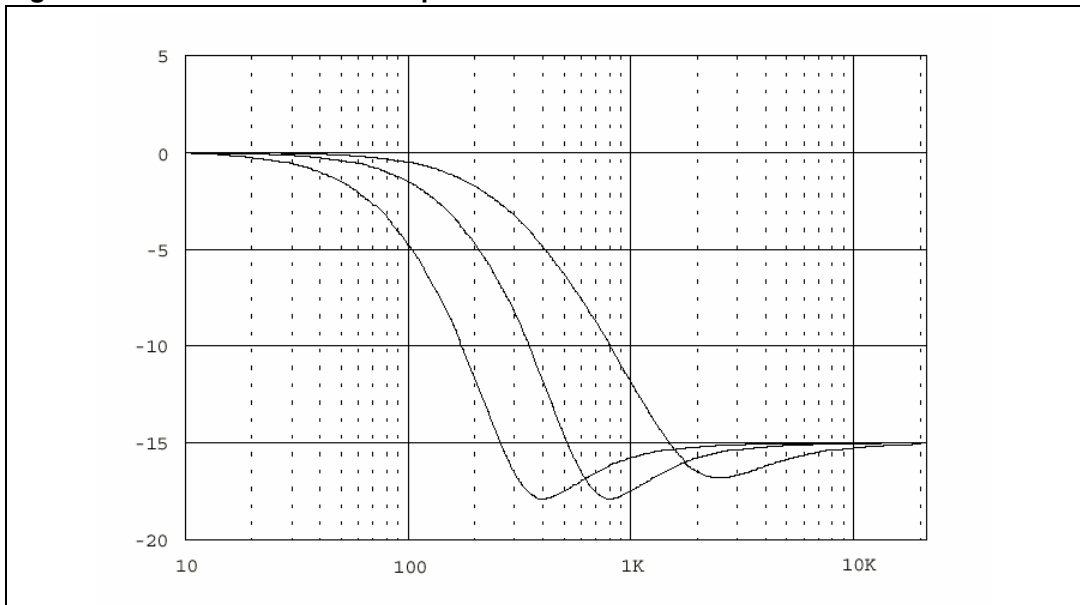

4.2.3 High frequency boost

Figure 6 shows the different Loudness shapes in low and high frequency boost.

Figure 6. Loudness attenuation, $f_c = 2.4$ kHz

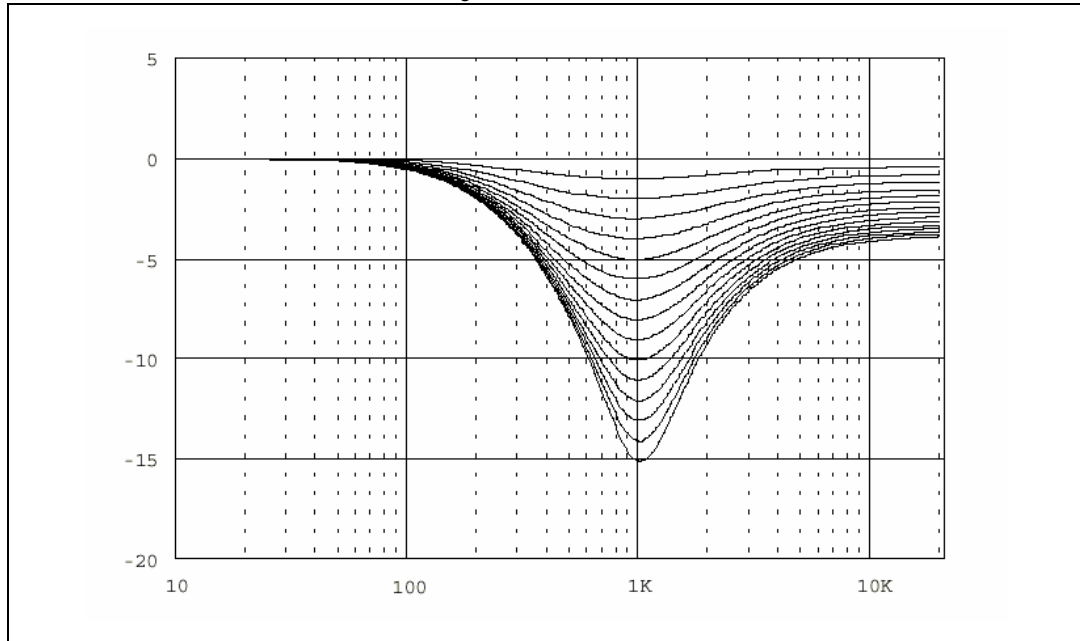

4.2.4 Flat mode

In flat mode the loudness stage works as a 0 dB to -15 dB attenuator.

4.3 SoftMute

The digitally controlled SoftMute stage allows muting/demuting the signal with a I²C bus programmable slope. The mute process can either be activated by the SoftMute pin or by the I²C bus. This slope is realized in a special S-shaped curve to mute slow in the critical regions (see [Figure 7](#)).

For timing purposes the bit 0 of the I²C bus output register is set to 1 from the start of muting until the end of demuting.

Figure 7. SoftMute timing

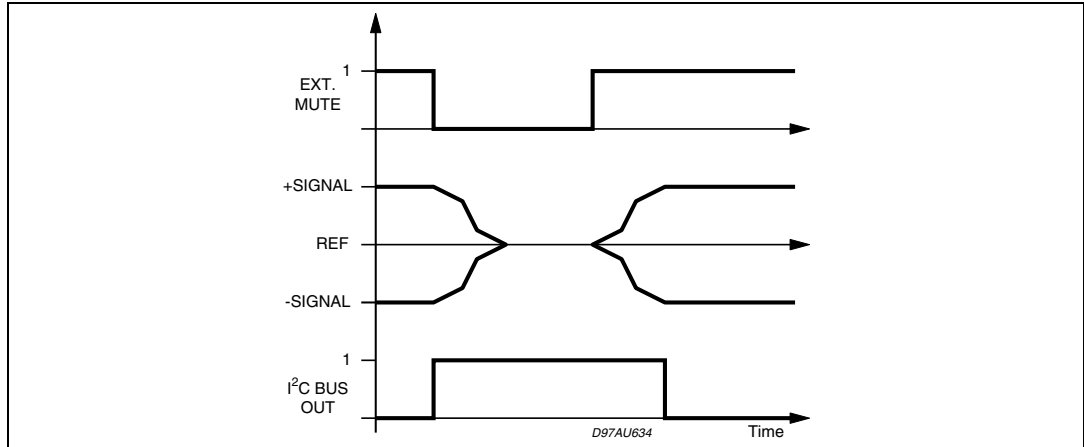

Note: Please notice that a started mute-action is always terminated and could not be interrupted by a change of the mute –signal.

4.4 SoftStep volume

When the volume-level is changed audible clicks could appear at the output. The root cause of those clicks could either be a DC-offset before the volume-stage or the sudden change of the envelope of the audio signal. With the SoftStep-feature both kinds of clicks could be reduced to a minimum and are no more audible. The blend-time from one step to the next is programmable as 5 ms or 10 ms. The SoftStep control is described in detail in [Chapter 4.9](#).

4.5 Bass

There are four parameters programmable in the bass stage:

4.5.1 Bass attenuation

Figure 8 shows the attenuation as a function of frequency at a center frequency of 80 Hz.

Figure 8. Bass control @ $f_C = 80$ Hz, $Q = 1$

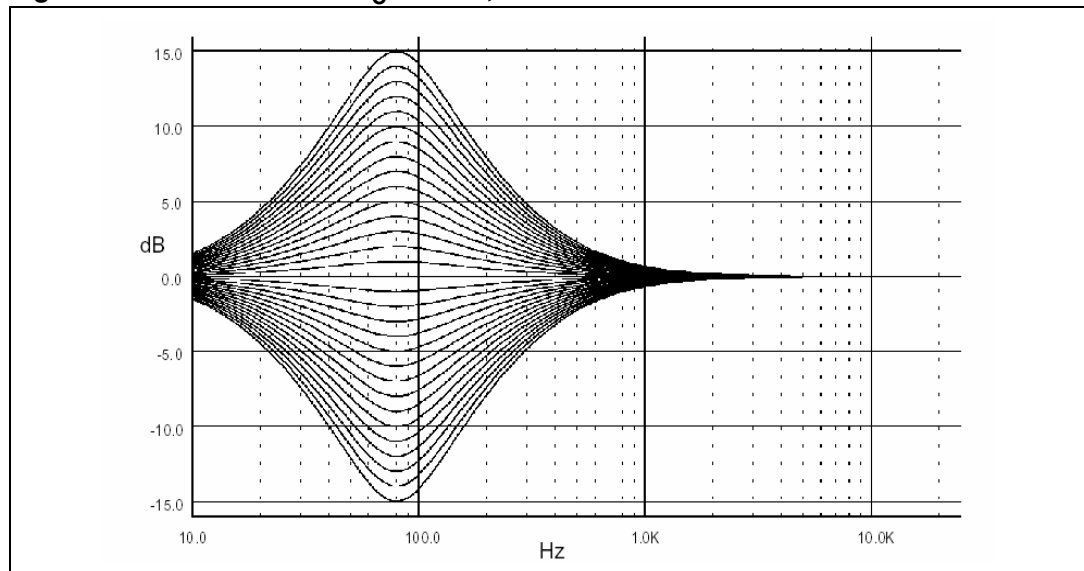

4.5.2 Bass center frequency

Figure 9 shows the four possible center frequencies 60, 80, 100 and 200 Hz.

Figure 9. Bass center frequencies @ gain = 14 dB, $Q = 1$

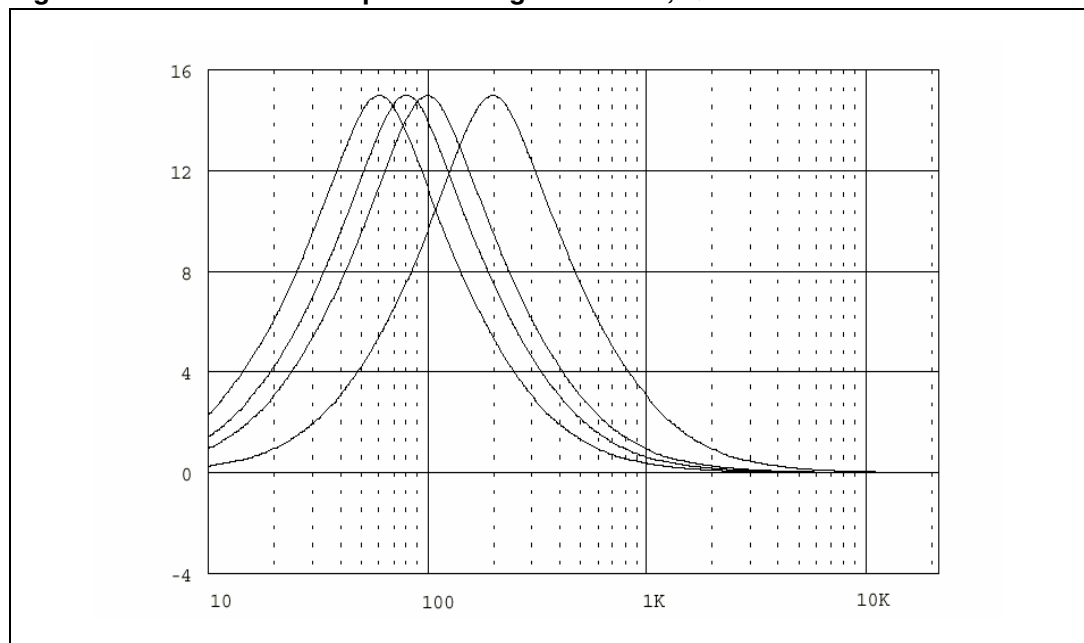

4.5.3 Quality factors

Figure 10 shows the four possible quality factors 1, 1.25, 1.5 and 2.

Figure 10. Bass quality factors @ gain = 14 dB, $f_C = 80$ Hz

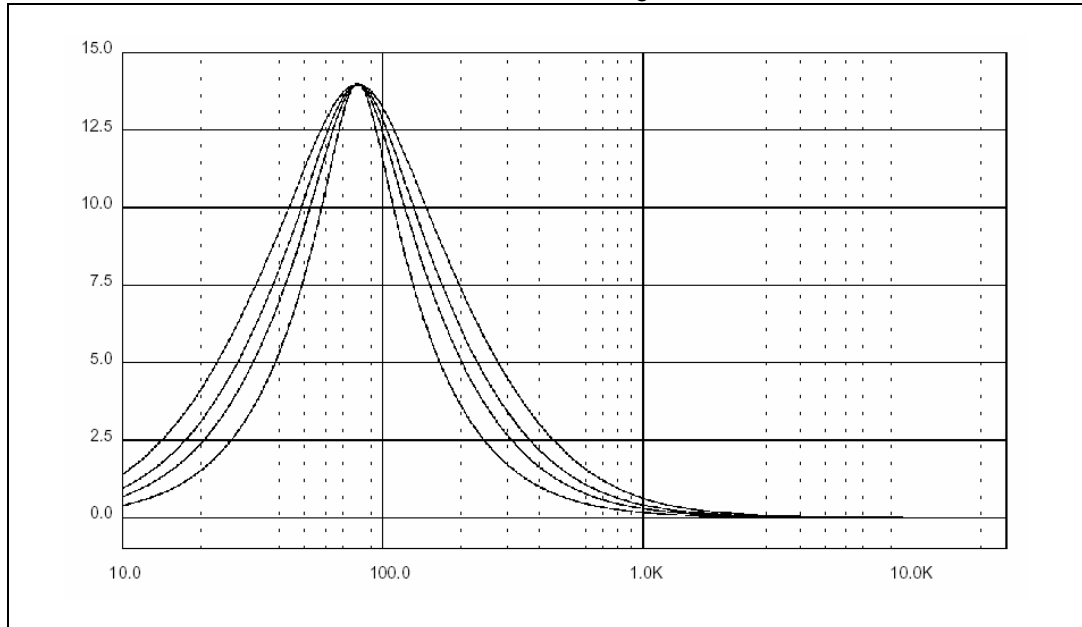

4.5.4 DC mode

In this mode the DC-gain is increased by 4.4 dB. In addition the programmed center frequency and quality factor is decreased by 25 % which can be used to reach alternative center frequencies or quality factors.

Figure 11. Bass normal and DC mode @ gain = 14 dB, $f_C = 80$ Hz

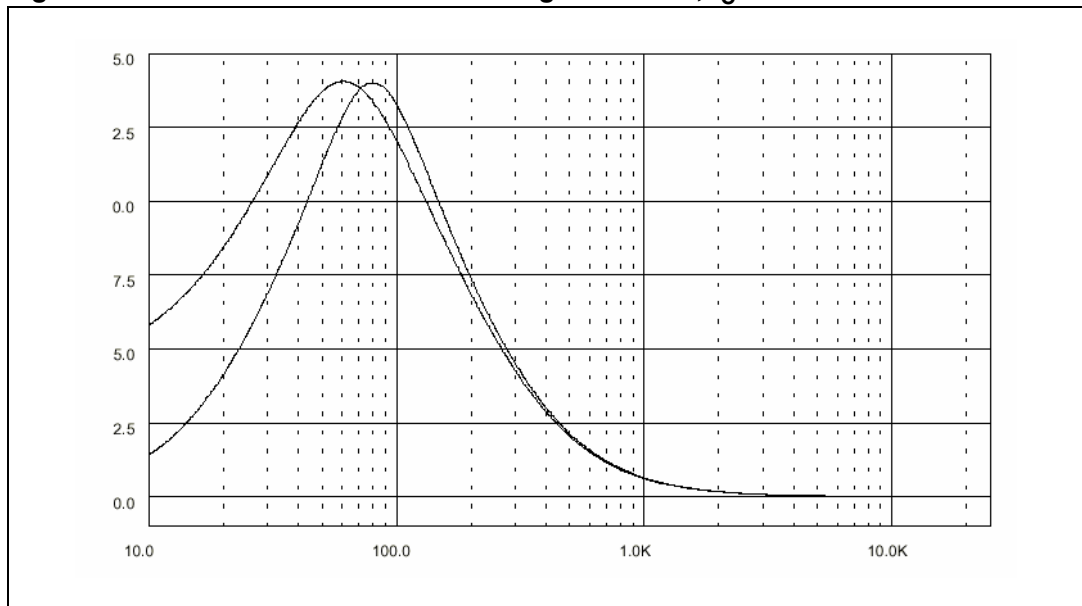

1. The center frequency, Q and DC-mode can be set fully independently.

4.6 Middle

There are three parameters programmable in the middle stage:

4.6.1 Middle attenuation

Figure 12 shows the attenuation as a function of frequency at a center frequency of 1 kHz.

Figure 12. Middle control @ $f_C = 1$ kHz, $Q = 1$

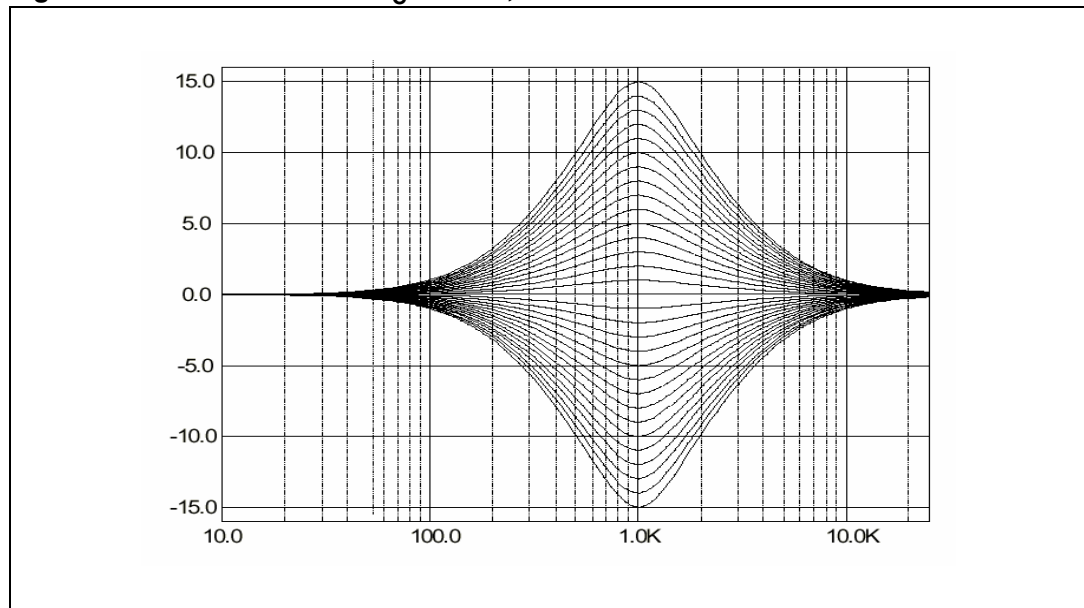

4.6.2 Middle center frequency

Figure 13 shows the four possible center frequencies 500 Hz, 1 kHz, 1.5 kHz and 2.5 kHz.

Figure 13. Middle center frequencies @ gain = 14 dB, $Q = 1$

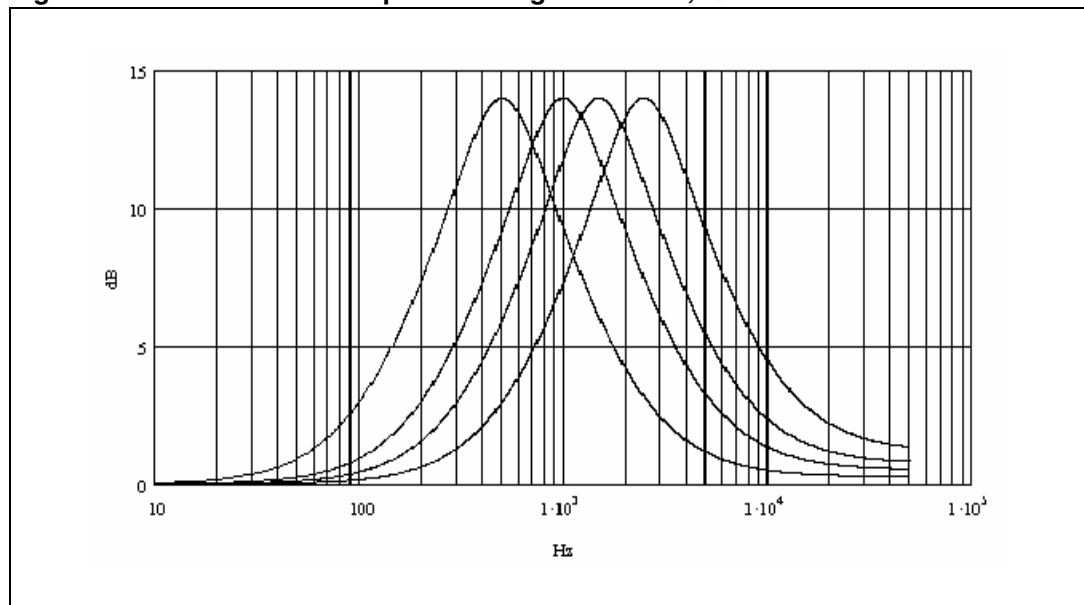

4.6.3 Quality factors

Figure 14 shows the three possible quality factors 0.75, 1 and 1.25.

Figure 14. Middle quality factors @ gain = 14 dB, $f_C = 1$ kHz

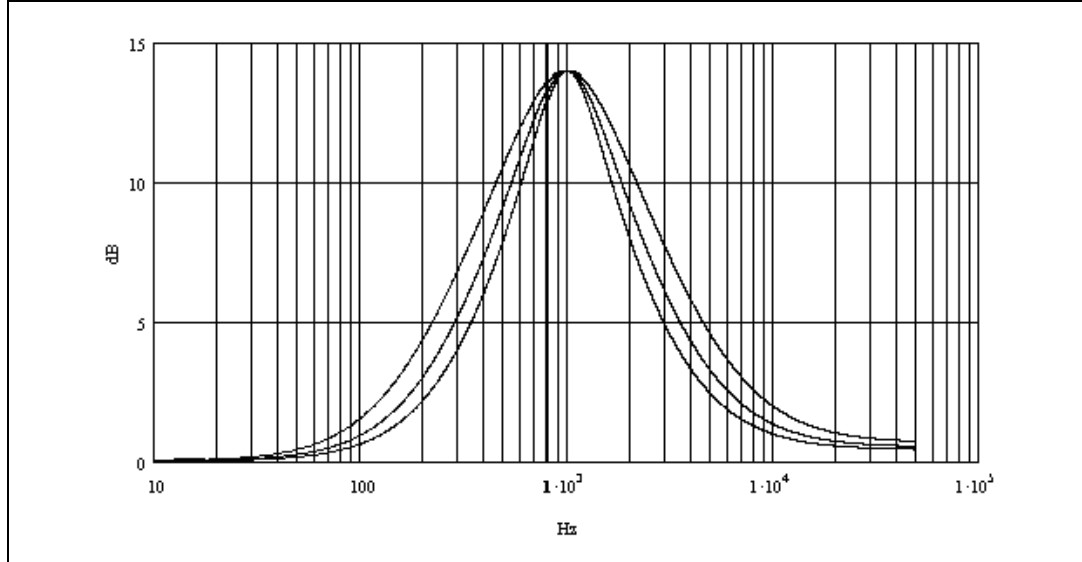

4.7 Treble

There are two parameters programmable in the treble stage:

4.7.1 Treble attenuation

Figure 15 shows the attenuation as a function of frequency at a center frequency of 17.5 kHz.

Figure 15. Treble control @ $f_C = 17.5$ kHz.

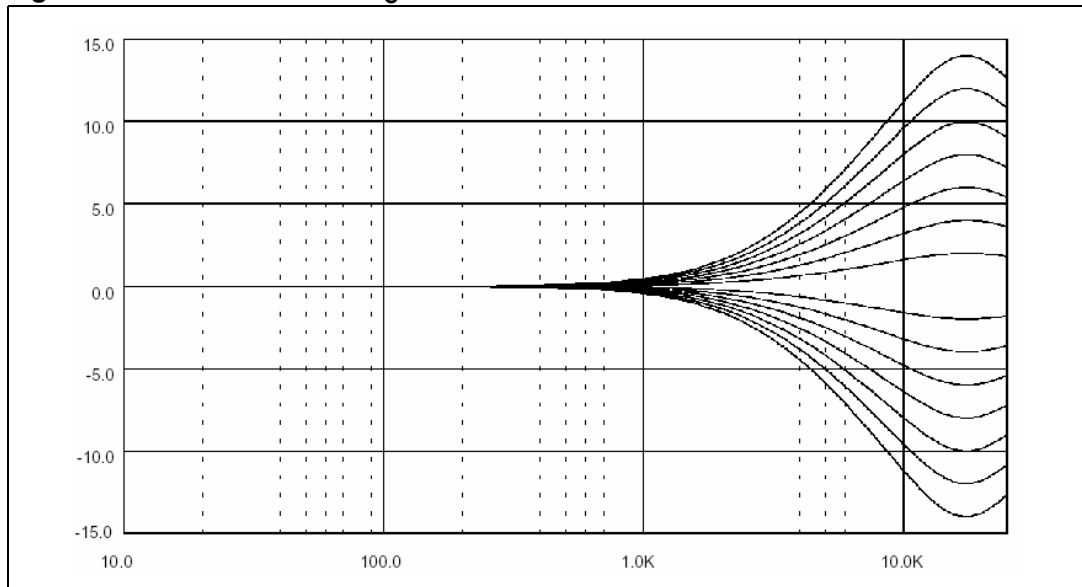

4.7.2 Center frequency

Figure 16 shows the four possible center frequencies 10 k, 12.5 k, 15 k and 17.5 kHz.

Figure 16. Treble center frequencies @ gain = 14 dB

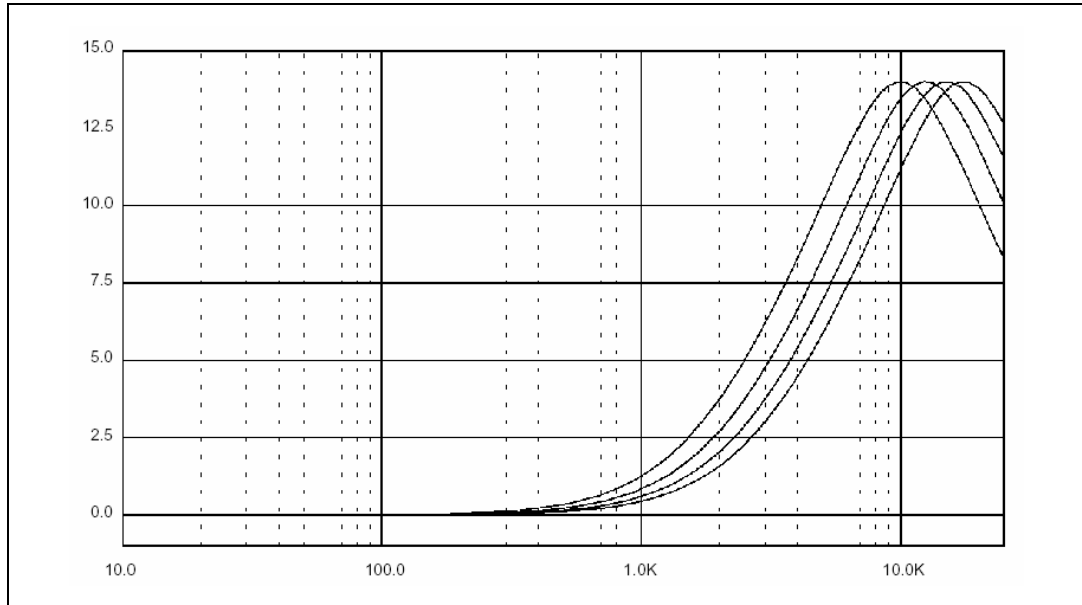

4.8 Subwoofer filter

The subwoofer lowpass filter has Butterworth characteristics with programmable cut-off frequency (55 Hz / 85 Hz / 120 Hz / 160 Hz). The output phase can be selected between 0 deg and 180 deg. The input of subwoofer takes signal from bass filter output or output of input mux.

Figure 17. Subwoofer cut frequencies

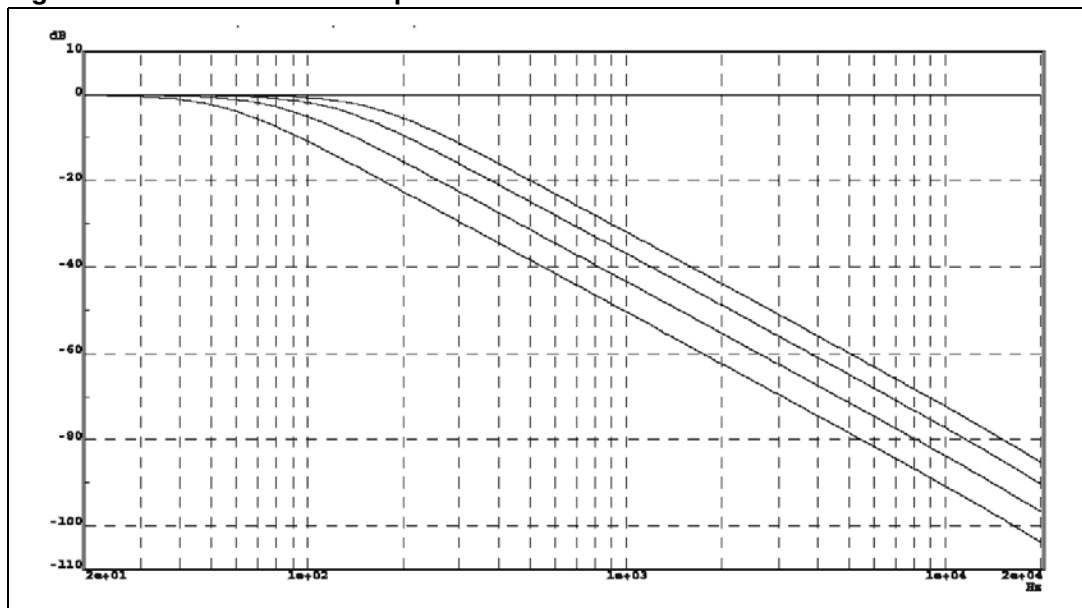

4.9 Softstep control

In this device, the softstep function is available for volume, speaker, loudness, treble, middle and bass block. With softstep function, the audible noise of DC offset or the sudden change of signal can be avoided when adjusting gain setting of the block.

For each block, the softstep function is controlled by softstep on/off control bit in the control table. The softstep transient time selection (5 ms or 10 ms) is common for all blocks and it is controlled by softstep time control bit. The softstep operation of all blocks has a common centralized control. In this case, a new softstep operation can not be started before the completion previous softstep.

There are two different modes to activate the softstep operation. The softstep operation can be started right after I²C data sending, or the softstep can be activated in parallel after data sending of several different blocks. The two modes are controlled by the 'act bit' (it is normally bit7 of the byte.) of each byte. When act bit is '0', which means action, the softstep is activated right after the date byte is sent. When the act bit is '1', which means wait, the block goes to wait for softstep status. In this case, the block will wait for some other block to activate the operation. The softstep operation of all blocks in wait status will be done together with the block which activate the softstep. With this mode, all specific blocks can do the softstep in parallel. This avoids waiting when the softstep is operated one by one.

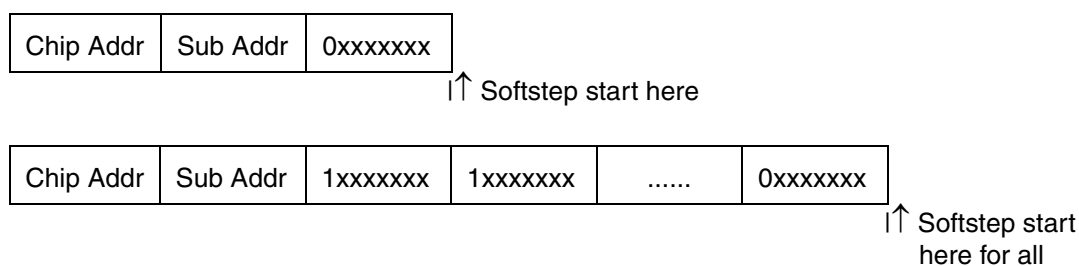

4.10 DC offset detector

Using the DC offset detection circuit ([Figure 18](#)) an offset voltage difference between the audio power amplifier and the APR's Front and Rear outputs can be detected, preventing serious damage to the loudspeakers. The circuit compares whether the signal crosses the zero level inside the audio power at the same time as in the speaker cell. The output of the zero-window-comparator of the power amplifier must be connected with the WinIn-input of the APR. The WinIn-input has an internal pull-up resistor connected to 5.5 V. It is recommended to drive this pin with open-collector outputs only.

To compensate for errors at low frequencies the WinTC-pin are implemented, with external capacitors introducing the same delay $\tau = 7.5 \text{ k}\Omega * C_{\text{ext}}$ as the AC-coupling between the APR and the power amplifier introduces. For the zero window comparators, the time constant for spike rejection as well as the threshold are programmable.

For electrical characteristics see [Chapter 3 on page 9](#).

A low-active DC-offset error signal appears at the DCErr output if the next conditions are both true:

- a) Front and rear outputs are inside zero crossing windows.
- b) The Input voltage VWinIn is logic low whenever at least one output of the power amplifier is outside the zero crossing windows.

4.11 Audioprocessor testing

In the test mode, which can be activated by setting bit D7 of the I²C subaddress byte and bit D0 of the testing audioprocessor byte, several internal signals are available at the SE1L pin. In this mode, the input resistance of 100 kΩ is disconnected from the pin. Internal signals available for testing are listed in the data-byte specification.

Figure 19. Test circuit

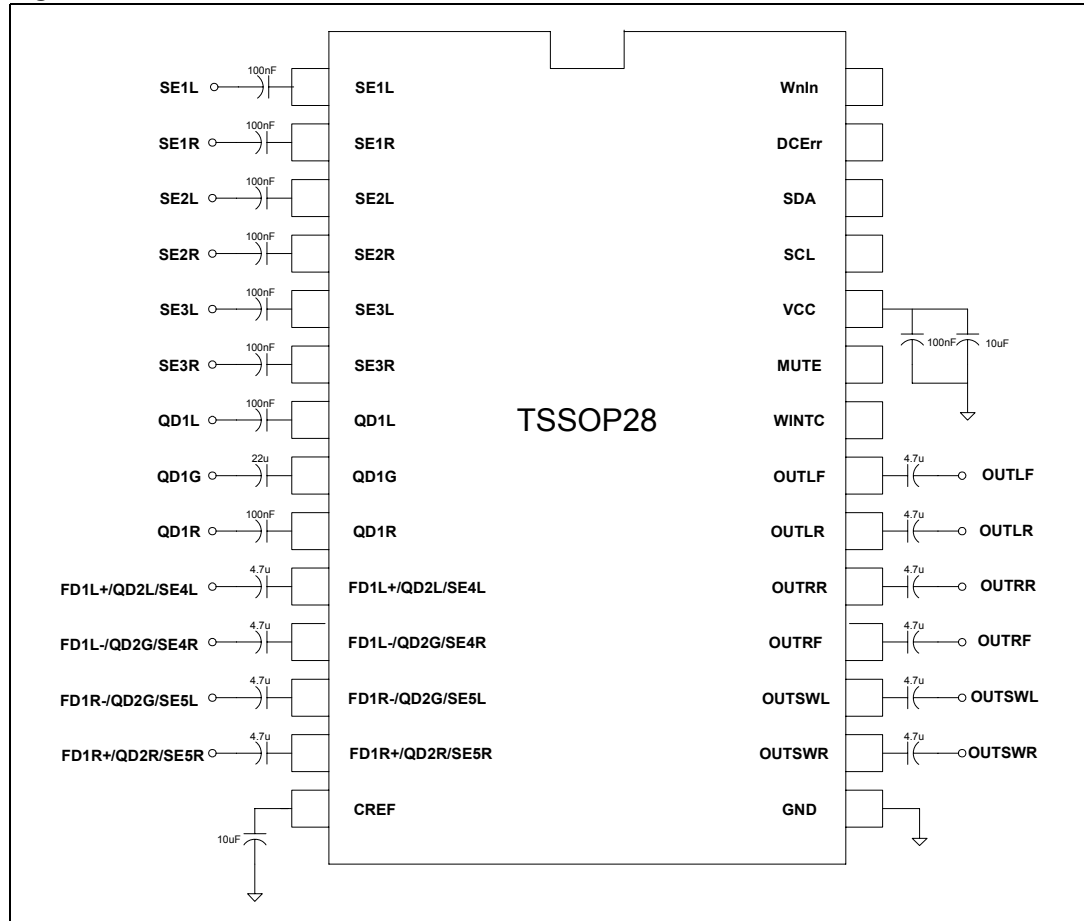

5 I²C bus specification

5.1 Interface protocol

The interface protocol comprises:

- a start condition (S)
- a chip address byte (the LSB determines read/write transmission)
- a subaddress byte
- a sequence of data (N-bytes + acknowledge)
- a stop condition (P)
- the max. clock speed is 400 kbit/s
- 3.3 V logic compatible

Figure 20. I²C bus interface protocol

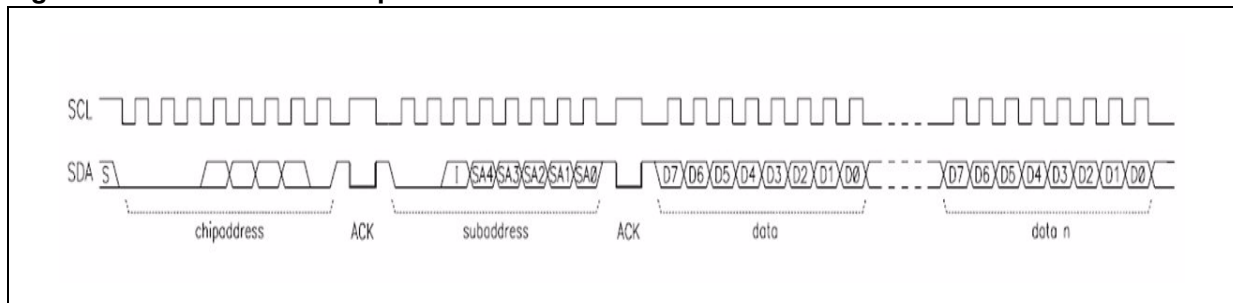

1. S = Start
2. ACK = Acknowledge

5.2 I²C bus electrical characteristics

Table 6. I²C bus electrical characteristics

Symbol	Parameter	Min	Max	Unit
f _{SCL}	SCL clock frequency	-	400	kHz
V _{IH}	High level input voltage	2.4	-	V
V _{IL}	Low level input voltage	-	0.8	V
t _{HD,STA}	Hold time for START	0.6	-	μs
t _{SU,STO}	Setup time for STOP	0.6	-	μs
t _{LOW}	Low period for SCL clock	1.3	-	μs
t _{HIGH}	High period for SCL clock	0.6	-	μs
t _F	Fall time for SCL/SDA	-	300	ns
t _R	Rise time for SCL/SDA	-	300	ns
t _{HD,DAT}	Data hold time	0	-	ns
t _{SU,DAT}	Data setup time	100	-	ns

Figure 21. I²C bus data

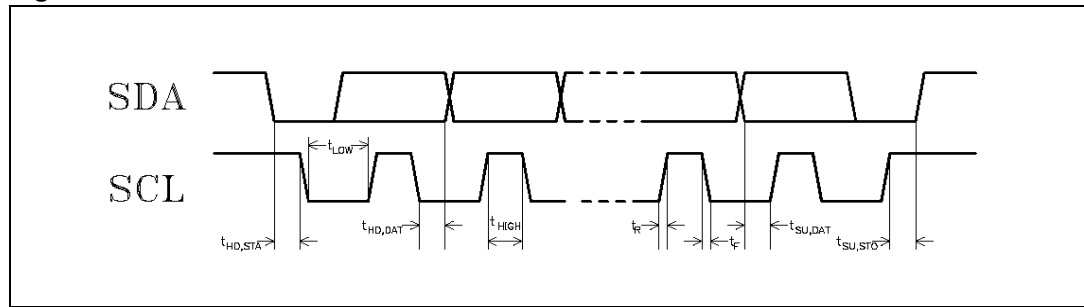

5.2.1 Receive mode

S	1	0	0	0	1	0	0	R/W	ACK	TS	X	AI	A4	A3	A2	A1	A0	ACK	DATA	ACK	P
---	---	---	---	---	---	---	---	-----	-----	----	---	----	----	----	----	----	----	-----	------	-----	---

S = Start

R/W = "0" -> Receive Mode (Chip can be programmed by μ P)

"1" -> Transmission Mode (Data could be received by μ P)

ACK = Acknowledge

P = Stop

TS = Testing mode

AI = Auto increment

5.2.2 Transmission mode

S	1	0	0	0	1	0	0	R/W	ACK	X	X	X	X	X	X	X	BZ	SM	ACK	P
---	---	---	---	---	---	---	---	-----	-----	---	---	---	---	---	---	---	----	----	-----	---

SM = Soft mute activated for main channel

BZ = Softstep Busy ('0' = Busy)

X = Not used

The transmitted data is automatic updated after each ACK. Transmission can be repeated without new chip address.

5.2.3 Reset condition

A Power-On-Reset is invoked if the supply voltage is below than 3.5 V. After that the registers are initialized to the default data written in following tables.

Table 7. Subaddress (receive mode)

MSB								LSB	Function
I2	I1	I0	A4	A3	A2	A1	A0		
0	-	-	-	-	-	-	-	Testing mode Off	
1	-	-	-	-	-	-	-	On	
-	x	-	-	-	-	-	-	Not used	
-	-	0	-	-	-	-	-	Auto increment mode Off	
-	-	1	-	-	-	-	-	On	
-	-	-	0	0	0	0	0	Main selector	
-	-	-	0	0	0	0	1	Not used	
-	-	-	0	0	0	1	0	Not used	
-	-	-	0	0	0	1	1	Not used	
-	-	-	0	0	1	0	0	Soft mute / others	
-	-	-	0	0	1	0	1	Soft step I	
-	-	-	0	0	1	1	0	Soft step II / DC-detector	
-	-	-	0	0	1	1	1	Loudness	
-	-	-	0	1	0	0	0	Volume / output gain	
-	-	-	0	1	0	0	1	Treble	
-	-	-	0	1	0	1	0	Middle	
-	-	-	0	1	0	1	1	Bass	
-	-	-	0	1	1	0	0	Subwoofer / middle / bass	
-	-	-	0	1	1	0	1	Speaker attenuator left front	
-	-	-	0	1	1	1	0	Speaker attenuator right front	
-	-	-	0	1	1	1	1	Speaker attenuator left rear	
-	-	-	1	0	0	0	0	Speaker attenuator right rear	
-	-	-	1	0	0	0	1	Subwoofer attenuator left	
-	-	-	1	0	0	1	0	Subwoofer attenuator right	
-	-	-	1	0	0	1	1	Testing audio processor 1	
-	-	-	1	0	1	0	0	Testing audio processor 2	
-	-	-	1	0	1	0	1	Testing audio processor 3	

5.3 Data byte specification

Table 8. Main selector (0)

MSB				LSB				Function
D7	D6	D5	D4	D3	D2	D1	D0	
-	-	-	-	-	0	0	0	Main source selector SE1 SE3 <u>QD1</u> QD2 / FD1 SE2 SE4 SE5 Mute
					0	0	1	
					0	1	0	
					0	1	1	
					1	0	0	
					1	0	1	
					1	1	0	
					1	1	1	
-	-	-	-	0	-	-	-	FD / QD2 selection FD <u>QD2</u>
				1				
-	-	-	0	-	-	-	-	Main source input gain select 0 dB <u>3 dB</u>
			1					
-	-	0	-	-	-	-	-	Subwoofer flat Off <u>On</u>
		1						
x	x	-	-	-	-	-	-	Not used

Not used (1-3)

Table 9. Soft mute / others (4)

MSB				LSB				Function
D7	D6	D5	D4	D3	D2	D1	D0	
-	-	-	-	-	-	-	0 1	Soft mute <u>On</u> <u>Off</u>
-	-	-	-	-	-	0 1	-	Pin influence for mute <u>Pin and IIC</u> <u>IIC</u>
-	-	-	-	0 0 1 1	0 1 0 1	-	-	Soft mute time 0.48 ms 0.96 ms 7.68 ms <u>15.36 ms</u>
-	-	-	0 1	-	-	-	-	Subwoofer input source <u>Input mux</u> <u>Bass output</u>
-	-	0 1	-	-	-	-	-	Subwoofer enable (OUTSWL & OUTSWR) <u>On</u> <u>Off</u>
-	0 1	-	-	-	-	-	-	Fast charge <u>On</u> <u>Off</u>
0 1	-	-	-	-	-	-	-	Anti-alias filter <u>On</u> <u>Off (bypass)</u>

Table 10. SoftStep I (5)

MSB				LSB				Function
D7	D6	D5	D4	D3	D2	D1	D0	
-	-	-	-	-	-	-	0 1	Loudness soft step On <u>Off</u>
-	-	-	-	-	-	0 1	-	Volume soft step On <u>Off</u>
-	-	-	-	-	0 1	-	-	Treble soft step On <u>Off</u>
-	-	-	-	0 1	-	-	-	Middle soft step On <u>Off</u>
-	-	-	0 1	-	-	-	-	Bass soft step On <u>Off</u>
-	-	0 1	-	-	-	-	-	Speaker LF soft step On <u>Off</u>
-	0 1	-	-	-	-	-	-	Speaker RF soft step On <u>Off</u>
0 1	-	-	-	-	-	-	-	Speaker LR soft step On <u>Off</u>

Table 11. SoftStep II / DC detector (6)

MSB				LSB				Function
D7	D6	D5	D4	D3	D2	D1	D0	
-	-	-	-	-	-	-	0 1	Speaker RR soft step On <u>Off</u>
-	-	-	-	-	-	0 1	-	Subwoofer left soft step On <u>Off</u>
-	-	-	-	-	0 1	-	-	Subwoofer right soft step On <u>Off</u>
-	-	-	-	0 1	-	-	-	Soft step time 5 ms <u>10 ms</u>
-	-	0 0 1 1	0 1 0 1	-	-	-	-	Zero-comparator window size ± 100 mV ± 75 mV ± 50 mV <u>± 25 mV</u>
0 0 1 1	0 1 0 1	-	-	-	-	-	-	Spike rejection time constant 11 μ s 22 μ s 33 μ s <u>44 μs</u>

Table 12. Loudness (7)

MSB							LSB		Function
D7	D6	D5	D4	D3	D2	D1	D0		
-	-	-	-	0	0	0	0	Attenuation 0 dB	
				0	0	0	1	-1 dB	
				:	:	:	:	:	
				1	1	1	0	-14 dB	
				1	1	1	1	-15 dB	
-	-	0	0	-	-	-	-	Center frequency Flat	
		0	1					400 Hz	
		1	0					800 Hz	
		1	1					2400 Hz	
-	0	-	-	-	-	-	-	High boost On	
	1							Off	
0	-	-	-	-	-	-	-	Soft step action Act	
1								Wait	

Table 13. Volume / output gain (8)

MSB							LSB		Function
D7	D6	D5	D4	D3	D2	D1	D0		
-	-	0	0	0	0	0	0	Gain/attenuation +0 dB	
		0	0	0	0	0	0	1	+1 dB
		:	:	:	:	:	:	:	:
		0	0	1	1	1	1	1	+15 dB
		0	1	0	0	0	0	0	+16 dB
		:	:	:	:	:	:	:	:
		0	1	0	1	1	1	1	+23 dB
		0	1	1	0	0	0	0	Not used
		:	:	:	:	:	:	:	:
		0	1	1	1	1	1	1	Not used
		1	0	0	0	0	0	0	-0 dB
		:	:	:	:	:	:	:	:
		1	0	1	1	1	1	1	-15 dB
		:	:	:	:	:	:	:	:
		1	1	1	1	1	1	1	-31 dB
-	0	-	-	-	-	-	-	Output gain 1 dB	
	1							0 dB	
0	-	-	-	-	-	-	-	Soft step action Act	
1								Wait	

Table 14. Treble filter (9)

MSB				LSB				Function		
D7	D6	D5	D4	D3	D2	D1	D0			
-	-	-	0	0	0	0	0	0	Gain/attenuation -15 dB	
			0	0	0	0	0	1	-14 dB	
			:	:	:	:	:	:	:	:
			0	1	1	1	1	0	0	-1 dB
			0	1	1	1	1	1	1	0 dB
			1	1	1	1	1	1	1	0 dB
			1	1	1	1	1	1	0	<u>+1 dB</u>
			:	:	:	:	:	:	:	:
			1	0	0	0	0	0	1	+14 dB
			1	0	0	0	0	+15 dB		
-	0	0	-	-	-	-	-	-	Treble center frequency 10.0 kHz	
	0	1							12.5 kHz	
	1	0							15.0 kHz	
	1	1							<u>17.5 kHz</u>	
0 1	-	-	-	-	-	-	-	-	Soft step action Act	
									Wait	

Table 15. Middle filter (10)

MSB				LSB				Function		
D7	D6	D5	D4	D3	D2	D1	D0			
-	-	-	0	0	0	0	0	0	Gain/attenuation -15 dB	
			0	0	0	0	0	0	1	-14 dB
			:	:	:	:	:	:	:	:
			0	1	1	1	1	1	0	-1 dB
			0	1	1	1	1	1	1	0 dB
			1	1	1	1	1	1	1	0 dB
			1	1	1	1	1	1	0	<u>+1 dB</u>
			:	:	:	:	:	:	:	:
			1	0	0	0	0	0	1	+14 dB
			1	0	0	0	0	+15 dB		
-	0	0	-	-	-	-	-	-	Middle Q factor 0.75	
	0	1							1	
	1	0							<u>1.25</u>	
	1	1							Reserved	
0 1	-	-	-	-	-	-	-	-	Soft step action Act	
									Wait	

Table 16. Bass filter (11)

MSB				LSB				Function
D7	D6	D5	D4	D3	D2	D1	D0	
-	-	-	0	0	0	0	0	-15 dB
			0	0	0	0	1	-14 dB
			:	:	:	:	:	:
			0	1	1	1	0	-1 dB
			0	1	1	1	1	0 dB
			1	1	1	1	1	0 dB
			1	1	1	1	0	+1 dB
			:	:	:	:	:	:
			1	0	0	0	0	1
			1	0	0	0	+15 dB	
-	0	0	-	-	-	-	-	Bass Q factor
	0	1						1.0
	1	0						1.25
	1	1						1.5
								<u>2.0</u>
0 1	-	-	-	-	-	-	-	Soft step action
								Act
								<u>Wait</u>

Table 17. Subwoofer / middle / bass (12)

MSB				LSB				Function
D7	D6	D5	D4	D3	D2	D1	D0	
-	-	-	-	-	-	0	0	Subwoofer cut-off frequency
						0	1	55 Hz
						1	0	85 Hz
						1	1	<u>120 Hz</u>
								160 Hz
-	-	-	-	-	0	-	-	Subwoofer output phase
					1			180 deg
								<u>0 deg</u>
-	-	-	0	0	-	-	-	Middle center frequency
			0	1				500 Hz
			1	0				1000 Hz
			1	1				1500 Hz
								<u>2500 Hz</u>
-	0	0	-	-	-	-	-	Bass center frequency
	0	1						60 Hz
	1	0						80 Hz
	1	1						100 Hz
								<u>200 Hz</u>
0 1	-	-	-	-	-	-	-	Bass DC mode
								On
								<u>Off</u>

Table 18. Speaker attenuation (FL/FR/RL/RR/SWL/SWR) (13-18)

MSB				LSB				Function
D7	D6	D5	D4	D3	D2	D1	D0	
-	0	0	0	0	0	0	0	0 dB
	0	0	0	0	0	0	1	1 dB
	:	:	:	:	:	:	:	:
	0	0	0	1	1	1	1	+15 dB
	0	0	1	0	0	0	0	-0 dB
	0	0	1	0	0	0	1	-1 dB
	:	:	:	:	:	:	:	:
	1	0	1	1	1	1	1	-78 dB
	1	0	1	1	1	1	1	-79 dB
1	1	1	x	x	x	x	x	<u>mute</u>
0	-	-	-	-	-	-	-	Soft step action
1	-	-	-	-	-	-	-	Act <u>Wait</u>

Table 19. Testing audio processor 1 (19)

MSB				LSB				Function
D7	D6	D5	D4	D3	D2	D1	D0	
-	-	-	-	-	-	-	0	Audio processor testing mode
							1	<u>Off</u> On
-	-	-	0	0	0	0	-	Test multiplexer at SE1L ⁽¹⁾
			0	0	0	1		SSCLK
			0	0	1	0		REQ
			0	0	1	1		SMCLK
			0	1	0	0		DCDet Vth High
			0	1	0	1		DCDet Vth Low
			0	1	1	0		IntZeroErr
			0	1	1	1		Ref5V5
			1	0	0	0		VGB1.95
			1	0	0	1		Clock200k
			1	0	1	0		SDCLK
			1	0	1	0		VrefDCO
-	-	0	-	-	-	-	-	Clock fast mode ⁽²⁾
		1						On <u>Off</u>
-	0	-	-	-	-	-	-	Clock source ⁽²⁾
	1							External <u>Internal (200 kHz)</u>
0	-	-	-	-	-	-	-	Attenuator gain clock control ⁽²⁾
1								On <u>Off</u>

1. The control bit needs both I²C test mode on & sub-address test mode on.

2. The control bit does not depend on test mode.

Table 20. Testing audio processor 2 (20)

MSB							LSB		Function
D7	D6	D5	D4	D3	D2	D1	D0		
-	-	-	-	-	-	-	0	Test architecture ⁽¹⁾ Normal Split	
							1		
-	-	-	-	-	-	0	-	Oscillator clock ⁽²⁾ 400 kHz 800 kHz	
						1			
-	-	-	-	-	0	-	-	Softstep curve ⁽²⁾ S-Curve Linear curve	
					1				
-	-	-	0	0	-	-	-	Manual set busy signal ⁽¹⁾ Auto Auto 0 1	
			0	1					
			1	0					
			1	1					
-	-	-	0	0	-	-	-	Request for clk generator ⁽¹⁾ Allow Allow Stopped Stopped	
			0	1					
			1	0					
			1	1					
-	-	0	-	-	-	-	-	No DCO spike rejection ⁽¹⁾ On Off	
		1							
x	x	-	-	-	-	-	-	Not used	

1. The control bit needs sub-address test mode on.

2. The control bit does not depend on test mode.

Table 21. Testing audio processor 3 (21)

MSB							LSB		Function
D7	D6	D5	D4	D3	D2	D1	D0		
-	-	-	-	-	-	-	0	Enable clock for FL/FR/RL/RR/SWL/SWR On Off	
							1		
-	-	-	-	-	-	0	-	Enable clock for volume On Off	
						1			
-	-	-	-	-	0	-	-	Enable clock for treble and bass On Off	
					1				
-	-	-	-	0	-	-	-	Enable clock for loudness and middle On Off	
				1					
x	x	x	x	-	-	-	-	Not used	

6 Package information

In order to meet environmental requirements, ST offers these devices in different grades of ECOPACK® packages, depending on their level of environmental compliance. ECOPACK® specifications, grade definitions and product status are available at: www.st.com.

ECOPACK® is an ST trademark.

Figure 22. TSSOP28 mechanical data and package dimensions

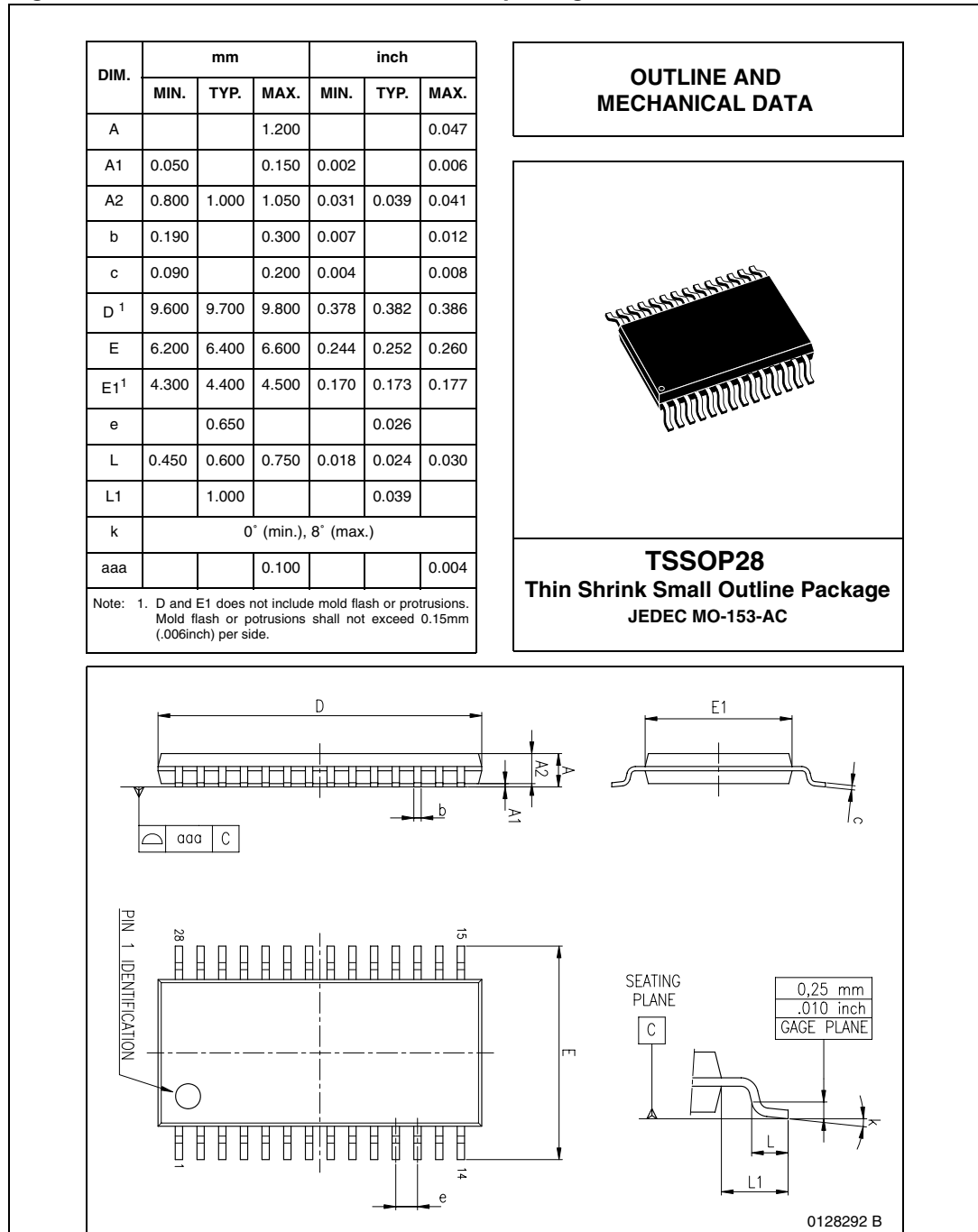

7 Revision history

Table 22. Document revision history

Date	Revision	Changes
21-Oct-2009	1	Initial release.

Please Read Carefully:

Information in this document is provided solely in connection with ST products. STMicroelectronics NV and its subsidiaries ("ST") reserve the right to make changes, corrections, modifications or improvements, to this document, and the products and services described herein at any time, without notice.

All ST products are sold pursuant to ST's terms and conditions of sale.

Purchasers are solely responsible for the choice, selection and use of the ST products and services described herein, and ST assumes no liability whatsoever relating to the choice, selection or use of the ST products and services described herein.

No license, express or implied, by estoppel or otherwise, to any intellectual property rights is granted under this document. If any part of this document refers to any third party products or services it shall not be deemed a license grant by ST for the use of such third party products or services, or any intellectual property contained therein or considered as a warranty covering the use in any manner whatsoever of such third party products or services or any intellectual property contained therein.

UNLESS OTHERWISE SET FORTH IN ST'S TERMS AND CONDITIONS OF SALE ST DISCLAIMS ANY EXPRESS OR IMPLIED WARRANTY WITH RESPECT TO THE USE AND/OR SALE OF ST PRODUCTS INCLUDING WITHOUT LIMITATION IMPLIED WARRANTIES OF MERCHANTABILITY, FITNESS FOR A PARTICULAR PURPOSE (AND THEIR EQUIVALENTS UNDER THE LAWS OF ANY JURISDICTION), OR INFRINGEMENT OF ANY PATENT, COPYRIGHT OR OTHER INTELLECTUAL PROPERTY RIGHT.

UNLESS EXPRESSLY APPROVED IN WRITING BY AN AUTHORIZED ST REPRESENTATIVE, ST PRODUCTS ARE NOT RECOMMENDED, AUTHORIZED OR WARRANTED FOR USE IN MILITARY, AIR CRAFT, SPACE, LIFE SAVING, OR LIFE SUSTAINING APPLICATIONS, NOR IN PRODUCTS OR SYSTEMS WHERE FAILURE OR MALFUNCTION MAY RESULT IN PERSONAL INJURY, DEATH, OR SEVERE PROPERTY OR ENVIRONMENTAL DAMAGE. ST PRODUCTS WHICH ARE NOT SPECIFIED AS "AUTOMOTIVE GRADE" MAY ONLY BE USED IN AUTOMOTIVE APPLICATIONS AT USER'S OWN RISK.

Resale of ST products with provisions different from the statements and/or technical features set forth in this document shall immediately void any warranty granted by ST for the ST product or service described herein and shall not create or extend in any manner whatsoever, any liability of ST.

ST and the ST logo are trademarks or registered trademarks of ST in various countries.

Information in this document supersedes and replaces all information previously supplied.

The ST logo is a registered trademark of STMicroelectronics. All other names are the property of their respective owners.

© 2009 STMicroelectronics - All rights reserved

STMicroelectronics group of companies

Australia - Belgium - Brazil - Canada - China - Czech Republic - Finland - France - Germany - Hong Kong - India - Israel - Italy - Japan - Malaysia - Malta - Morocco - Philippines - Singapore - Spain - Sweden - Switzerland - United Kingdom - United States of America

www.st.com